



Eaton 9E Rack

Advanced User Guide

9E1000IR

9E2000IR

9E3000IR

9EEBM72R

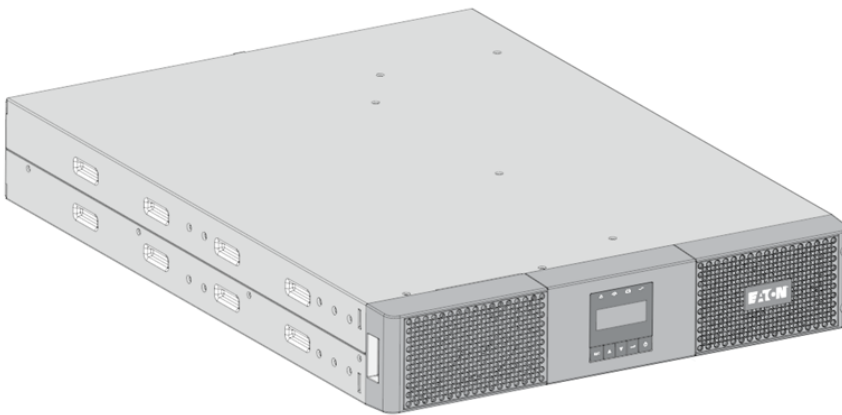

Copyright © 2023 EATON

All rights reserved.

DPD-9E2305

English











Table of Content

1	Special symbols	1
2	Introduction	2
2.1	Environmental protection	2
2.2	Benefits.....	3
3	Presentation.....	4
3.1	Weights and dimensions.....	4
3.2	Standard installation	5
3.3	Rear panel.....	5
3.4	Optional accessories.....	5
4	Installation	6
4.1	Inspecting the equipment	6
4.2	Recommended positions.....	7
4.3	EBM connection	8
4.4	UPS connection.....	9
4.5	Register warranty.....	9
5	Interfaces and communication	9
5.1	Control panel.....	9
5.2	LCD description.....	10
5.3	Display functions.....	11
5.4	User settings.....	12
5.5	Communication ports.....	15
5.6	UPS remote control functions	16
5.7	Eaton Intelligent Power Software suite	17
5.8	Cybersecurity	17
6	Operation	17
6.1	Start-up and normal operation	17
6.2	Starting the UPS on battery.....	17
6.3	UPS shutdown.....	17
6.4	Operating modes	17
6.5	Return of AC input power	18
6.6	Configuring battery settings.....	18
6.7	Setting high efficiency mode	19

7	UPS maintenance.....	19
7.1	Equipment care.....	19
7.2	Storing the equipment.....	19
7.3	When to replace batteries.....	19
7.4	Replacing batteries	20
7.5	Recycling the used equipment	21
8	Troubleshooting.....	22
8.1	Typical alarms and faults.....	22
8.2	Service and support.....	24
9	Specification and technical characteristics.....	24
9.1	Electrical input	24
9.2	Electrical output.....	25
9.3	Battery	26
9.4	Environmental and safety	26
10	Glossary	27

1 Special symbols

The following are examples of symbols used on the UPS or accessories to alert you to important information:

	DANGER: Dangerous voltage levels are present within the UPS. The UPS has its own internal power source (the battery). Consequently, the power outlets may be energized even if the UPS is disconnected from the AC power source.
	Important instructions that must always be followed. CAUTION: Batteries present a risk of energy or electrical shock or burn from high short circuit current. Observe proper precaution. Batteries may contain HIGH VOLTAGE and CORROSIVE, TOXIC and EXPLOSIVE substances.
	Information, advice, help.
	Read the documentation provided.
	Disconnect input plug.
	Before maintenance, first shut down the UPS then disconnect the AC power source, internal and external batteries then discharge capacitors by pressing the ON button and wait 5 minutes.
	This equipment should only be used in a dry indoor environment.
	Operating range of temperature.
	Operating range of humidity.
	The UPS and their batteries must be kept in a ventilated place.

2 Introduction

Thank you for selecting an Eaton 9E product to protect your electrical equipment.

The Eaton 9E range has been designed with the utmost care. We recommend that you take the time to read this advanced user guide to take full advantage of the many features of your UPS (Uninterruptible Power System).

Before installing your Eaton 9E, please read the information and safety instructions provided. Follow the instructions in the quick start guide and if necessary, refer to this advance user guide.

To discover the entire range of Eaton products, we invite you to visit our web site at eaton.com or contact your Eaton local representative.

2.1 Environmental protection

Eaton has implemented an environmental-protection policy. Products are developed according to an eco-design approach.

Substances

This product contains no CFC, HCFC or asbestos. This product is compliant with regulations on the restriction of the use of substances in electrical and electronic equipment.

Packaging

To improve waste treatment and facilitate recycling, separate the various packing components.

- The cardboard we use comprises over 50% of recycled cardboard.
- Plastic bags are made of polyethylene.
- Packing materials are recyclable and bear the appropriate identification symbol.



Materials	Abbreviations	Number in the symbols
Polyethylene terephthalate	PET	01
High-density polyethylene	HDPE	02
Polyvinyl chloride	PVC	03
Low-density polyethylene	LDPE	04
Polypropylene	PP	05
Polystyrene	PS	06

Follow all local regulations for the disposal of packing materials.

End of life

Eaton will process products at the end of their service life in compliance with local regulations. Eaton works with companies in charge of collecting and eliminating our products at the end of their service life.

Product

The product is made from materials that can be recycled. Dismantling and destruction must take place in compliance with all local regulations concerning waste. At the end of its service life, the product must be transported to a processing center for electrical and electronic waste. eaton.com/recycling

Battery

The product contains lead-acid batteries that must be processed according to applicable local regulations concerning batteries. The battery may be removed to comply with regulations and in view of correct disposal.

2.2 Benefits

The Eaton 9E uninterruptible power system (UPS) protects your sensitive electronic equipment from the most common power problems, including power outages, voltage sags, impulsive transients, line noise, and long-term under and over voltage conditions, frequency variations, switching transients, and harmonic distortion.

Power outages can occur when you least expect it and power quality can be erratic. These power problems have the potential to corrupt critical data, destroy unsaved work sessions, and damage hardware - causing hours of lost productivity and expensive repairs.

With the Eaton 9E, you can safely eliminate the effects of power disturbances and guard the integrity of your equipment. Providing outstanding performance and reliability, the Eaton 9E's unique benefits include:

- True online double-conversion technology with high power density, utility frequency independence, and generator compatibility.
- Optional connectivity cards with enhanced communication capabilities.
- Extended runtime with up to four Extended Battery Modules (EBMs) per UPS (for models 9E2000IR and 9E3000IR)

3 Presentation

3.1 Weights and dimensions

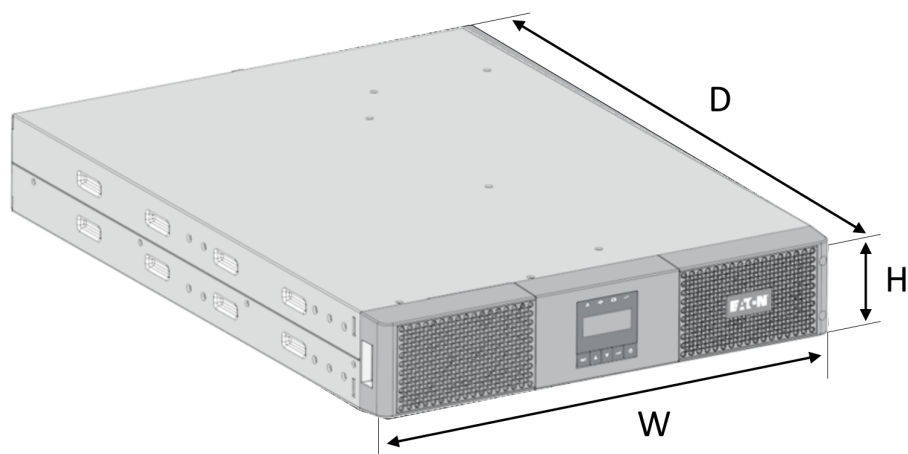

Description	Weights (kg / lbs)	Dimensions (mm / inch) D x W x H
9E1000IR	17.6 / 38.8	438 x 438 x 86.5 / 17.2 x 17.2 x 3.4
9E2000IR	29.9 / 63.9	608 x 438 x 86.5 / 23.9 x 17.2 x 3.4
9E3000IR	31.3 / 68.3	608 x 438 x 86.5 / 23.9 x 17.2 x 3.4
9EEBM72R	41.6 / 90.4	608 x 438 x 86.5 / 23.9 x 17.2 x 3.4

3.2 Standard installation

3.3 Rear panel

9E1000IR

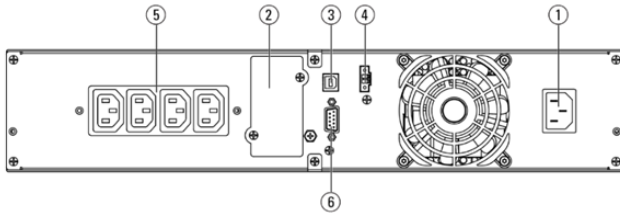

- ① Input AC power source
- ② Slot for optional communication card
- ③ USB communication port
- ④ Connector RPO (Remote Power Off)
- ⑤ Outlets
- ⑥ RS232 communication port

9E2000IR

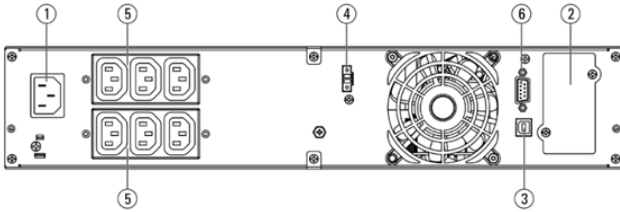

9E3000IR

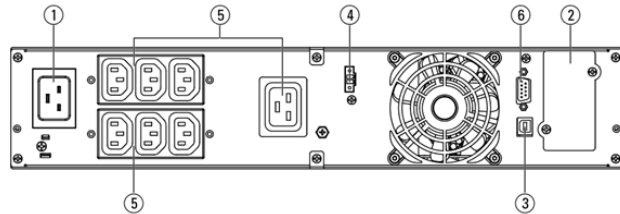

9EEBM72R

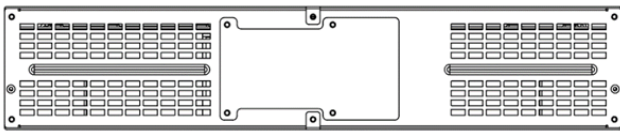

3.4 Optional accessories

Part number	Description
9EEBM72R	Extended Battery Module for 9E2000IR and 9E3000IR
Network-M2 Network-M3	Eaton Gigabit Network Card (SNMP v1/v3 and IP v4/v6 // Ethernet 10/100/1000BaseT)
INDGW-M2	Eaton Industrial Gateway Card (Modbus TCP / RTU)
Relay-MS	Eaton Relay card (1 x RS232 or 5 x Relay output)
INDRELAY-MS	Eaton Industrial relay card (5x relay outputs with dry contacts for remote alarm information)
EMPDT1H1C2	Environmental Monitoring Probe Gen2 Compatibility : Gigabit Network Card (Network-M2, Network-M3) / Industrial Gateway Card (INDGW-M2)

4 Installation

4.1 Inspecting the equipment

If any equipment has been damaged during shipment, keep the shipping cartons and packing materials for the carrier or place of purchase and file a claim for shipping damage. If you discover damage after acceptance, file a claim for concealed damage.

To file a claim for shipping damage or concealed damage:

1. File with the carrier within 15 days of receipt of the equipment
2. Send a copy of the damage claim within 15 days to your service representative



Check the battery recharge date on the shipping carton label. If the date has passed and the batteries were never recharged, do not use the UPS. Contact your local service representative.

Package content

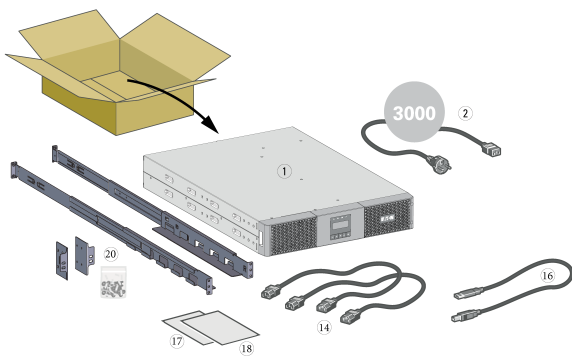

Verify that the following additional items are included with the UPS:

- ① UPS
- ② Connection cable to AC power source (9E3000IR model only)
- ⑭ Connection cables for the protected equipment
- ⑯ USB communication cable
- ⑰ Instructions and Safety Information
- ⑱ Quick start
- ⑳ Rack kit for 19-inch 4-post enclosures

4.2 Recommended positions

Installation in rack position

Follow steps below for module mounting on the rails.



The rails and necessary hardware are supplied by Eaton.

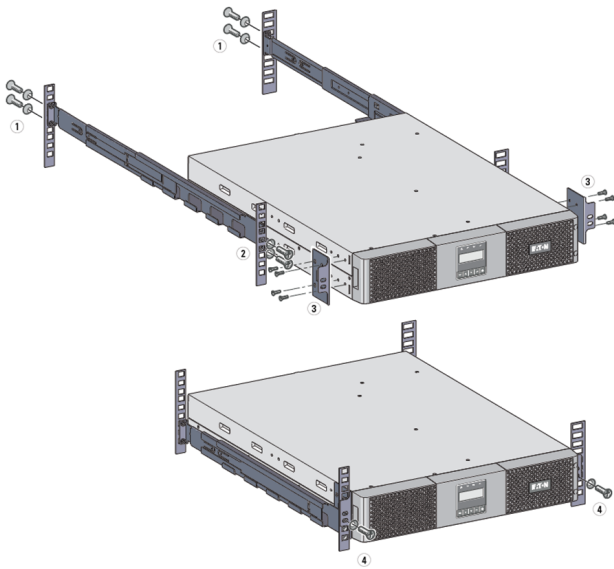



- ① Screw the rail on the back of the rack.
- ② Screw the rail on the front of the rack using the two holes at the bottom.
- ③ Screw the ears plate to the UPS.
- ④ Place the UPS on the rails and screw the ears plate to the top hole of the rail.

4.3 EBM connection

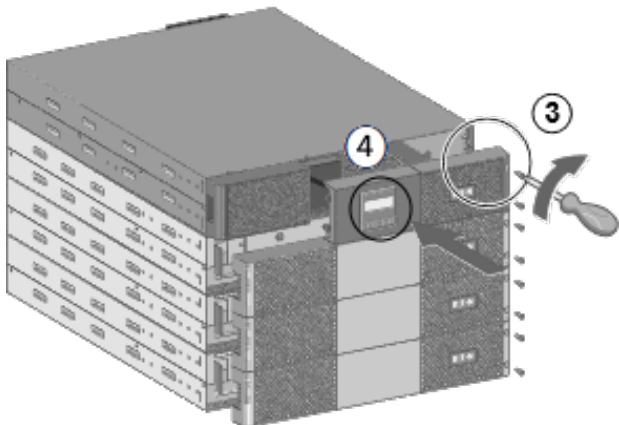
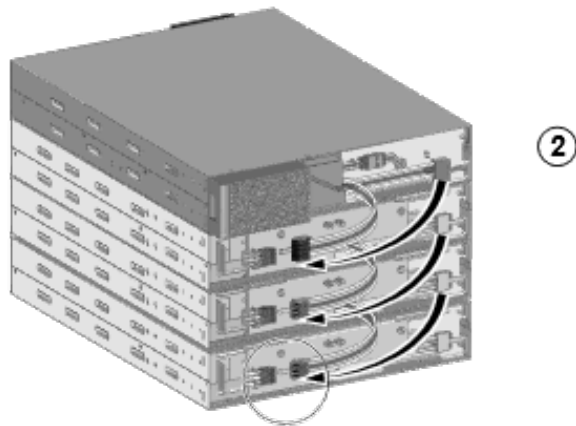
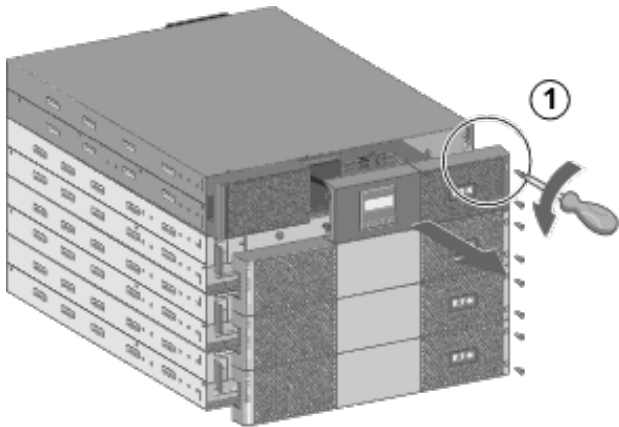
Rack installation



 A small amount of arcing may occur when connecting an EBM to the UPS. This is normal and will not harm personnel. Insert the EBM cable into the UPS battery connector quickly and firmly.

 To increase stability, it is preferable to place the EBM below the UPS.

Extension Battery Module (EBM) Eaton 9EEBM72R is compatible only with 9E2000IR and 9E3000IR UPS.

UPS must be switch off and disconnected from the power supply prior to battery installation.

Only qualified service personnel is allowed to install the EBM when UPS is working.

1. Remove UPS and EBM front panel.
2. Plug the EBM power cable(s) into the battery connector(s). Up to 4 EBMs could be connected to the UPS. Verify that the EBM connections are tight, and that adequate bend radius and strain relief exist for each cable.
3. Put back the UPS and EBM front panel.
4. Select the number of EBM connected through the LCD (Settings > Battery Settings > EBM)

4.4 UPS connection

Power supply connection

 Check that the indications on the name plate located on the back of the UPS correspond to the AC-power source and the true electrical consumption of the total load.

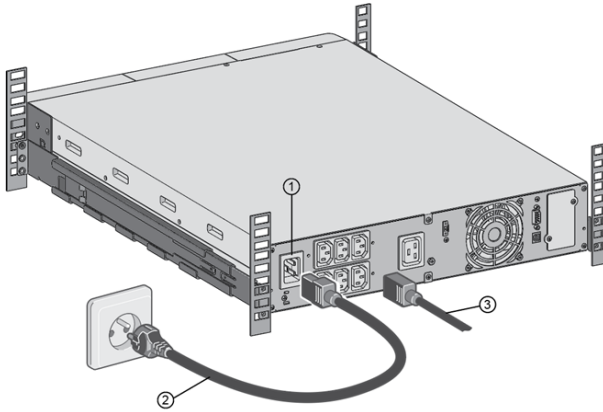

For 9E1000IR and 9E2000IR:

1. Connect the UPS input socket ① to the AC-power source using the cable of the protected equipment.
2. Connect the loads to the UPS using the cables ③.

For 9E3000IR:

1. Connect the supplied cable ② to the socket ①, then to the AC-power source.
2. Connect the loads to the UPS using the cables ③, for high-power devices choose the 16A outlet.

4.5 Register warranty

Register warranty at <https://www.pqproductregistration.eaton.com>

5 Interfaces and communication

5.1 Control panel



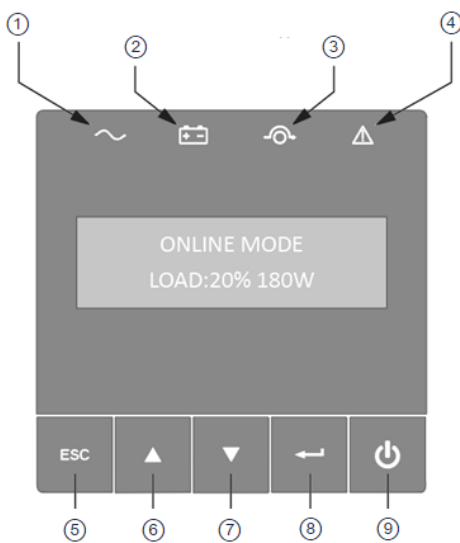

The screen provides useful information about the UPS itself, load status, events, measurements and settings.



- ① Power ON indicator (green)
- ② On battery indicator (orange)
- ③ On bypass indicator (orange)
- ④ Alarm indicator (red)
- ⑤ Escape
- ⑥ Up
- ⑦ Down
- ⑧ Enter
- ⑨ On/Off button

Led indicator

The following table shows the indicator status and description :

Indicator	Status	Description
 Green	On	The UPS is "ON" and the load is protected.
 Orange	On	The UPS is in battery mode and the load is protected.
 Orange	On	The UPS is in bypass mode.
 Red	On	The UPS has an active alarm or fault. See troubleshooting page for additional information.

5.2 LCD description



- ① Operation status
- ② Load/equipment status

By default, or after 5 minutes of inactivity, the LCD displays the screen saver. The backlight LCD automatically dims after 5 minutes of inactivity. Press any button to restore the screen.

 Note. If other indicator appears, see troubleshooting page for additional information.

The following table describes the ① Operation status information provided by the UPS :

① Operation status	Description	Action
STANDBY MODE	The UPS is OFF, waiting for start-up command from user.	Equipment is not powered until button  is pressed during start up and the green "normal mode" LED indicator is illuminated.
ONLINE MODE	The UPS is operating normally.	The UPS is powering and protecting the equipment.
BATTERY MODE	A utility failure has occurred, and the UPS is operating in Battery mode.	The UPS is powering the equipment with battery power. Prepare your equipment for shutdown.

① Operation status	Description	Action
BACKUP END MODE	The UPS is in Battery mode and the battery is running low.	This "Battery Low" warning is approximate, and the actual time to shutdown may vary significantly depending on the UPS load.
HIGH EFFIC. MODE	The UPS is operating in High Efficiency mode.	The UPS is powering and protecting the equipment.
FORCED BP MODE	An overload or a fault has occurred, or a command has been received, and the UPS is operating in Bypass mode.	Equipment is powered but not protected by the UPS.
FREQ CONV MODE	The UPS is operating in Frequency Converter Mode.	The UPS is powering and protecting the equipment. And output frequency is fixed.
EMERGENCY OFF	The UPS is switched off, the remote power off command is active.	To restart the UPS the RPO command needs to be deactivated.
other (faults or alarms)	The UPS is operating with faults or alarms.	Please check troubleshooting. Some faults and alarms show string, but other faults only show code.

5.3 Display functions

Press the Enter (↵) button to activate the menu options. Use the two middle buttons (▲ and ▼) to scroll through the menu structure. Press the Enter (↵) button to select an option. Press the (ESC) button to cancel or return to the previous menu.

Menu map for display functions

The following table describes the ② Load/equipment status information provided by the UPS :

② Load/equipment status	middle buttons (▲ and ▼)	Description
LOAD:xxx% xxxxW	(default screen) Load percentage and Watt	The LOAD data screen specifies the amount of power that the connected equipment is currently using in terms of percentage and Watt.
LOAD:xxx % xxxxVA	Load percentage and VA	The OUTPUT LOAD LEVEL screen indicates the load percentage and VA output load level.
LOAD PF:x.xx	Output load power factor	The OUTPUT LOAD POWER FACTOR screen indicates the power factor of connected equipment.
IN:xxxV xx.xHZ	Input voltage and frequency	The INPUT VOLTAGE & FREQUENCY screen displays current data.
OUT:xxxV xx.xHZ	Output voltage and frequency	The OUTPUT VOLTAGE & FREQUENCY screen displays current data.

② Load/equipment status	middle buttons (▲ and ▼)	Description
BAT:xxx.xV xxx%	Battery voltage and charge percentage	The BATTERY voltage screen tracks the charge level of your connected battery bank in terms of voltage and charge percentage.
RUNTIME:xxxMIN	Remaining battery runtime	The RUNTIME remaining screen tracks the approximate minutes of runtime available under the current loading and battery pack configuration. The runtime value will automatically re-calculate as connected equipment power consumption changes.
EBM: x	External battery quantity	The EBM screen displays external battery quantity. This screen is only for long time models.
DEMAND E:x.xxKWH	Demand energy	The DEMAND ENERGY screen offers continuous data on the KWh (kilowatt-hour) that connected equipment has consumed in the last one-hour period.

5.4 User settings

The following table displays the options that can be changed by the user.

Main Menu	Submenu	Available settings	Default settings
Control	Go to Bypass/ Go back normal	The Go to Bypass menu is built to give the user the ability to transfer the UPS to bypass mode.	
	Battery Test	The Battery Test function initiates a UPS self-battery test.	
	Reset Fault State	Reset Fault State command tries to clear all the faults, but some faults with a fault cause still present cannot be cleared. Reset Fault State is done in through “reset fault state” menu.	
	Clear Event Log	Clear event log is used to clear history log.	
	Reset Power Usage	Reset power usage is used to reset the power used.	
	Restore Factory Setting	The Restore Factory Settings provides the user a means to restore factory settings through the menu.	

Main Menu	Submenu	Available settings	Default settings
Local settings	Language	[English] [Français] [Deutsch] [Español] [Italiano] [Português] [Polish] Menus, status, notices and alarms, UPS fault, Event Log data and settings are in all supported languages.	[English] Automatic message for user configuration when UPS is powered for the first time.
	Protected access	[Enabled] [Disabled] Allow the user to lock the settings modification. Password is: 0577	[Disabled]
	Audible alarm	[Enabled] [Disabled on battery] [Always Disabled] Enable or disable the buzzer if an alarm occurs.	[Enabled]
In/Out settings	Output voltage	[200V][208V][220V][230V][240V]	[230 V]
	Output frequency	[Auto sensing] [Frequency Converter 50Hz] [Frequency Converter 60Hz]	[Auto sensing]
	HE Mode	[Enabled] [Disabled]	[Disabled]
	Overload prealarm	[50%] ... [102%] Load % when overload alarm occurs	[102%]
ON/OFF settings	Cold Start	[Enabled] [Disabled]	[Enabled]
	Auto Restart	[Enabled] [Disabled]	[Enabled]
	Auto Start	[Enabled] [Disabled]	[Disabled]
	Start On Bypass	[Enabled] [Disabled]	[Disabled]
	Sleep Mode	[Enabled] [Disabled] If Disabled, LCD and communication will turn OFF immediately after UPS is OFF. If Enabled, LCD and communication stay ON	[Enabled]
	Site Wiring Fault	[Enabled] [Disabled] Prevents the UPS from starting if the phase and neutral wires are swapped.	[Disabled]

Main Menu	Submenu	Available settings	Default settings
Battery settings	Auto battery test	In constant charge mode: [No test] [Daily] [Weekly] [Monthly]	[Monthly]
	Restart batt. level	[0%] ... [100%] Automatic restart will occur only when the set percentage of battery charge is reached, and "Auto Restart" is enabled and set to ON. A setting of 0% allows immediate automatic restart when utility returns after a UPS shutdown due to an extended power outage.	[0%]
	Battery low capacity	[Capacity] [0%] ... [100%] The alarm triggers when the set percentage of battery capacity or remaining back-up time is reached.	[0%]
	Battery low remaining time	[Runtime] [0min] ... [60min]	[3min]
	External battery	EBM quantity [0][1][2][3][4]	[0]
Comm settings	Remote power off	[No][ROO][RPO][Building Alarm] [Forced Bypass][On generator]	[No]
Event Log	/	List of log up to 50 items	
Identification	/	<ol style="list-style-type: none"> 1. Type 2. Model 3. Part Number 4. Serial Number 5. UPS Firmware 6. NMC Firmware 7. COM Card IPV4 8. COM Card IPV6 9. COM Card MAC address 	

5.5 Communication ports

Connection of RS232/USB communication port

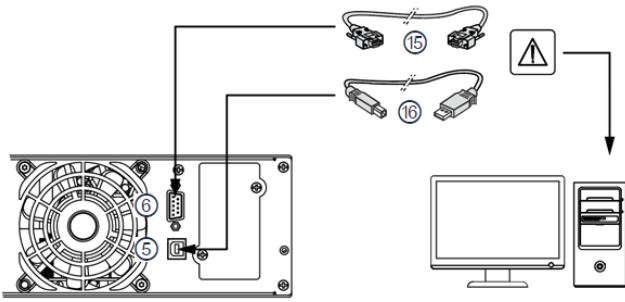

1. Connect the RS232 (15) or USB (16) communication cable to the serial or USB port on the computer equipment.
2. Connect the other end of the communication cable (15) or (16) to the USB (5) or RS232 (6) communication port on the UPS.

i The UPS can now communicate with Eaton power management software.

You can improve the remote monitoring and power management of the UPS by adding a [communication card](#) compatible with the 9E product.

Please note that cable (15) is not supplied with your equipment.

Installation of the communication cards

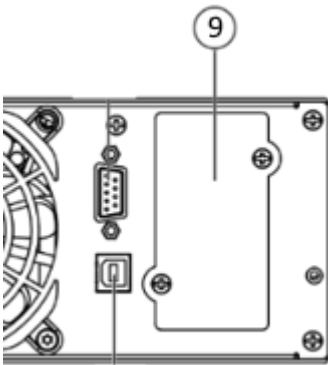

It is not necessary to shutdown the UPS before installing a communication card.

1. Remove the slot cover (9) secured by screws.
2. Insert the communication card in the slot.
3. **Secure the card cover with the two screws to connect the comm card to the ground.**

5.6 UPS remote control functions

Connectivity cards

Connectivity cards allow the UPS to communicate in a variety of networking environments and with different types of devices. The 9E models have one available communication bay for the following connectivity cards:

- **Gigabit Network card (Network-M2, Network-M3)** : provides a Gigabit Ethernet connection and enables secure UPS monitoring over HTTPS web browser interface, SNMP v1/v3 protocol and email alarms. In addition, up to 3 Environmental Monitoring Probes can be attached to obtain humidity, temperature, smoke alarm, and security information.
- **Industrial Gateway card (INDGW-M2)** : Provides Modbus RTU and Modbus TCP communication support in addition to the same secure UPS monitoring, management and sensor capability as the Gigabit Network card.
- **Relay-MS card** : provides isolated dry contact (Form-C) relay outputs for UPS status: Utility failure, Battery low, UPS alarm/OK, or on Bypass.
- **INDRELAY-MS** : The Industrial relay Card-MS (INDRELAY-MS) provides a simple way to remotely input UPS information to an alarm system, PLC or a computer system via dry contacts. It offers five isolated dry contact outputs and one isolated dry contact input.

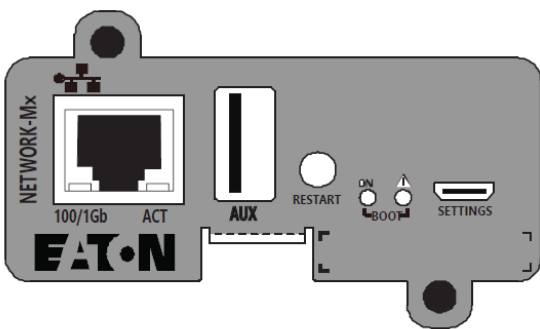

Network-M2, Network-M3 Card

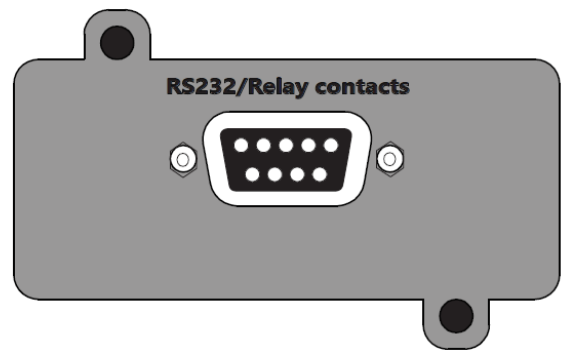

Relay-MS Card

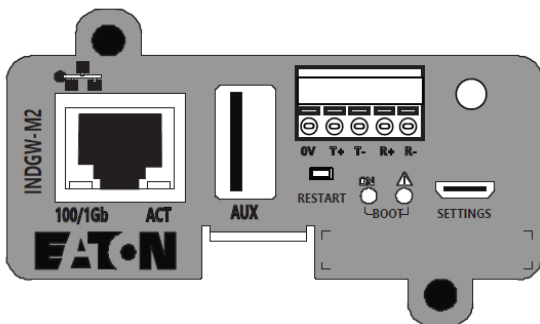

INDGW-M2

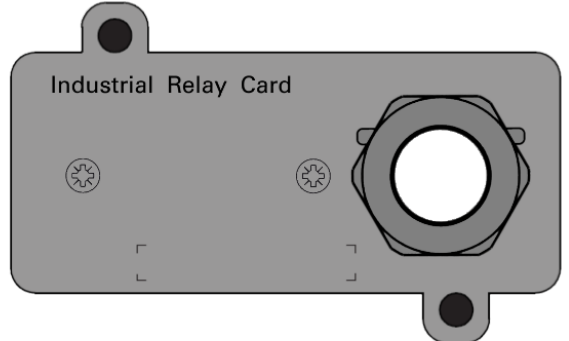

INDRELAY-MS

Remote control connection and test

Check that the UPS is OFF and disconnected from the AC input source.

Remove connector (4) after unscrewing the screws.

Connect a normally closed volt-free contact (60 V DC / 30 V AC max., 20 mA max., 0.75 mm² cable cross-section) between the two pins of connector (4) (see diagram).

Warning. This connector must only be connected to SELV (Safety Extra-Low Voltage) circuits.

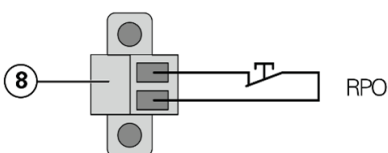

Contact open: UPS shutdown, LED  turns ON

To return to normal operation, deactivate the remote external contact and restart the UPS by pressing button 

5.7 Eaton Intelligent Power Software suite

Eaton Intelligent Power Software suite is available from eaton.com/downloads.

Eaton Software suite provides up-to-date graphics of UPS power and system data and power flow.

It also gives you a complete record of critical power events, and it notifies you of important UPS or power information. If there is a power outage and the 9E UPS battery power becomes low, Eaton Software suite can automatically shut down your computer system to protect your data before the UPS shutdown occurs.

5.8 Cybersecurity

Eaton is committed to minimizing the Cybersecurity risk in its products and employs cybersecurity best practices and the latest cybersecurity technologies in its products and solutions, making them more secure, reliable and competitive for our customers. Eaton also offers Cybersecurity Best Practices whitepapers to its customers, referenced at www.eaton.com/cybersecurity.

6 Operation

6.1 Start-up and normal operation



Check that the indications on the name plate located on the back of the UPS meets to the AC power source and the true electrical consumption of the total load.

Battery charge

The UPS charges the battery as soon as it is connected to the AC outlet, whether the ON/OFF button is pressed or not. It is recommended that the UPS be permanently connected to the AC power supply to ensure the best possible autonomy.

6.2 Starting the UPS on battery



Before using this feature, the UPS must have been powered by utility power with output enabled at least once. Battery start can be disabled. See the "Cold start" setting in "[ON/OFF Settings](#)".

To start the UPS on battery:

1. When the UPS is disconnected from the AC power source, press the  button on the UPS front panel.
The UPS transfers from Standby mode to Battery mode.
The UPS supplies power to your equipment.
2. Check the UPS front panel display for active alarms or notices besides the "Battery mode" and related notifications that indicates missing utility power. Resolve any active alarms before continuing. See "[Troubleshooting](#)".
Check the UPS status from the front panel to view the active alarms. Correct the alarms and restart if necessary.

6.3 UPS shutdown

To shut down the UPS:

Press the  button on the front panel for two seconds.

6.4 Operating modes

The Eaton 9E front panel indicates the UPS status through the UPS indicators located above the LCD screen.

Normal mode

Optional High Efficiency and Energy Saving settings minimize heat contribution to the rack environment. See user settings.

Battery mode



When the UPS is operating during a power outage, the alarm beeps once every ten seconds and the indicator illuminates solid.

The necessary energy is provided by the battery.

When the utility power returns, the UPS transfers to Normal mode operation while the battery recharges.

If battery capacity becomes low while in Battery mode, the audible alarm beeps faster.

This warning is approximate, and the actual time to shutdown may vary significantly; shutdown all applications on connected equipment due to imminent UPS shutdown.

When utility power is restored after the UPS shuts down, the UPS automatically restarts.

End of battery backup time

- All the LEDs go OFF.
- The audible alarm stops.

Bypass mode

In the event of a UPS overload or internal failure, the UPS transfers your equipment to utility power. Battery mode is not available and your equipment is not protected; however, the utility power continues to be passively filtered by the UPS. The by-pass indicator illuminates in orange.

Depending on overload conditions, the UPS remains in Bypass mode for at least five seconds and will stay in this mode if three transfers to Bypass occur within 20 minutes.

The UPS transfers to Bypass mode when:

- the user activates Bypass mode through the front panel,
- the UPS detects an internal failure,
- the UPS has an overtemperature condition,
- the UPS has an overload condition listed.

The UPS shuts down after a specified delay for overload conditions listed.

6.5 Return of AC input power

Following an outage, the UPS restarts automatically when AC input power returns (unless the restart function has been disabled) and the load is supplied again.

6.6 Configuring battery settings

Automatic battery test

Automatic battery tests are done every month in constant charging mode. The tests frequency can be modified. During the test, the UPS transfers to Battery mode and discharges the batteries for 10 seconds under load.

Battery mode is not displayed and battery low alarm is not activated during a battery test.

The battery test may be postponed due to bad conditions, or failed if battery is not ok.

Low battery warning

During discharge, the low battery alarm is activated if the remaining runtime goes below 3 minutes or less than the setting capacity threshold (0% by default).

This threshold can be modified.

External battery setting

The number of Extended Battery Module is manually set in LCD menu.

Deep discharge protection

This setting is recommended to avoid damaging the battery. Warranty is void if deep discharge protection is disabled.

6.7 Setting high efficiency mode

In High Efficiency mode, the UPS operates normally on Bypass and transfers to Online (or Battery) mode in less than ten ms when utility fails. Transfers to High Efficiency mode will be active after five minutes of Bypass voltage monitoring: if Bypass quality is not in tolerance, then the UPS will remain in Online mode.



Eaton recommends to use the HE mode only to protect IT equipment.

To set the High Efficiency mode:

1. Select Settings, In/Out settings, and High Efficiency mode.
2. Select Enabled and Enter to confirm.
3. The UPS transfers to High Efficiency mode after five minutes.

7 UPS maintenance

7.1 Equipment care

For the best preventive maintenance, keep the area around the equipment clean and dust free. If the atmosphere is very dusty, clean the outside of the system with a vacuum cleaner.

For full battery life, keep the equipment at an ambient temperature of 25 °C (77 °F).

The batteries are rated for a 3-5 year service life. The length of service life varies, depending on the frequency of usage and ambient temperature (life divided by 2 each 10 °C above 25 °C).

If the UPS requires any type of transportation, verify that the UPS is turned off.

Batteries used beyond expected service life will often have severely reduced runtimes. Replace batteries at least every 4 years to keep units running at peak performance.

Batteries runtime will be reduced at low temperature (below 10 °C).

7.2 Storing the equipment

If you store the equipment for a long period, recharge the battery every 6 months by connecting the UPS to utility power. The internal batteries charge to 90% capacity in less than 3 hours. However, Eaton recommends that the batteries charge for 48 hours after long-term storage.

Check the battery recharge date on the shipping carton label. If the date has passed and the batteries were never recharged, do not use them. Contact your service representative.

7.3 When to replace batteries

Eaton 9E batteries have an expected life span of 3-5 years, after that period you should take proactive steps to ensure batteries replacement for optimal operation and reliability, contact your service representative to order new batteries.

7.4 Replacing batteries

For battery replacement, follow Eaton instructions provided on www.eaton.eu/BatteryServices.

Battery replacement should be performed by **qualified service personnel** knowledgeable of batteries and required precautions. Keep unauthorized personnel away from batteries. Batteries can be replaced easily without turning off the UPS or disconnecting the load.



DO NOT DISCONNECT the batteries while the UPS is in Battery mode.

Consider all warnings, cautions, and notes before replacing batteries.

- Replace with the same type and number of batteries or battery packs. Contact your service representative to order new batteries.
- Batteries can present a risk of electrical shock or burn from high short circuit current.
- Do not wear any metal objects including watches and rings.
- Do not lay tools or metal parts on top of batteries.
- Proper disposal of batteries is required. Refer to your local codes for disposal requirements.
- Do not dispose of batteries in a fire. When exposed to flame, batteries may explode
- Do not open or mutilate the battery or batteries. Released electrolyte is harmful to the skin and eyes and may be extremely toxic.
- Determine if the battery is inadvertently grounded. If inadvertently grounded, remove source from ground. Contact with any part of a grounded battery can result in electrical shock.
The likelihood of such shock can be reduced if such grounds are removed during installation and maintenance (applicable to equipment and remote battery supplies not having a grounded supply circuit).
- **ELECTRIC ENERGY HAZARD.** Do not attempt to alter any battery wiring or connectors. Attempting to alter wiring can cause injury.
- Failed batteries can reach temperatures that exceed the burn thresholds for touchable surfaces.

Replacing the internal battery :

The internal battery is heavy. Use caution when handling the heavy batteries.



A Phillips head screwdriver is needed to perform this procedure

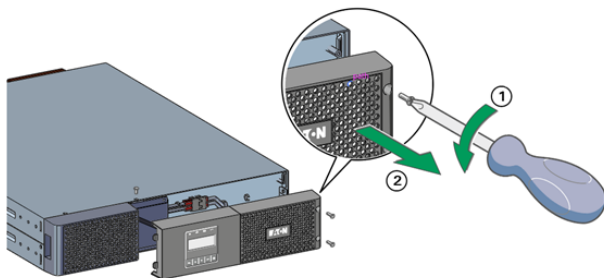

- ① Remove the 3 fixing screws of the front panel.
- ② Pull the front panel toward you to unclip it from the cabinet.

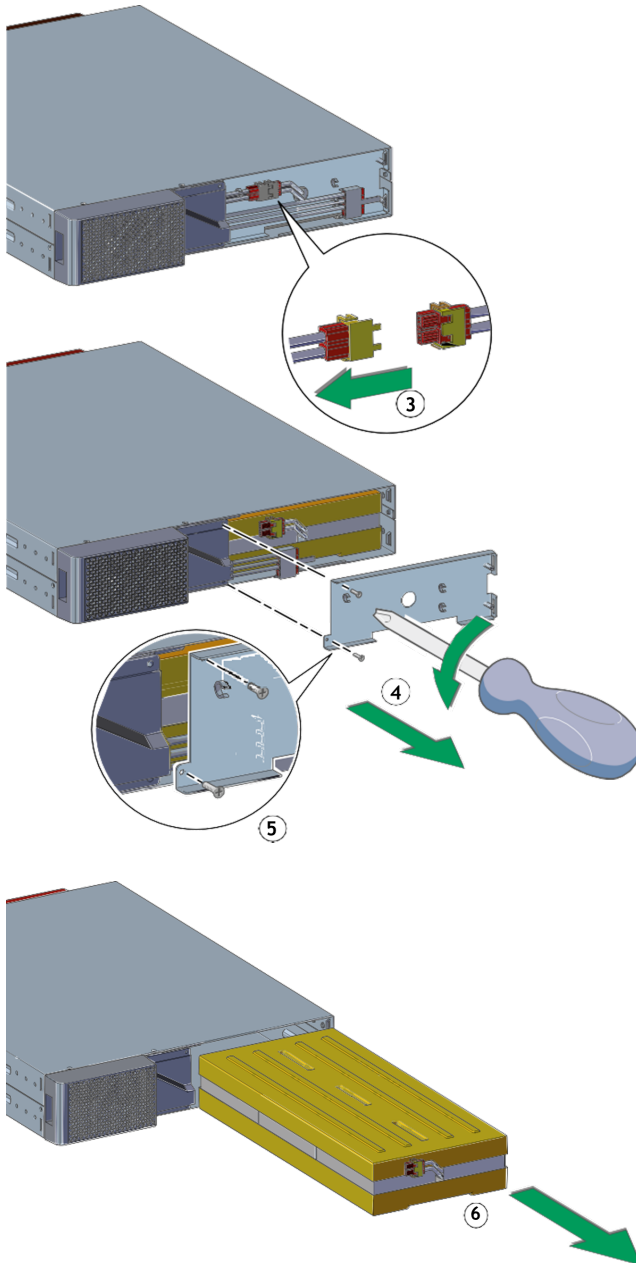

- ③ Disconnect the internal battery connector.
- ④ Unscrew and remove the 2 screws of the metal battery cover.
- ⑤ Remove the battery cover to free the battery pack.

⑥ Pull out the plastic handle of the battery pack and slide the pack out slowly on to a flat and stable surface. Use two hands to support the battery pack. See "Recycling the used equipment" section for proper disposal.

Verify that the replacement batteries have the same rating as the batteries being replaced. Put the new battery pack into the UPS. Push the battery pack firmly to ensure a proper connection.

Reassemble in the reverse order, finally follow instructions "Testing new batteries" below.

Testing new batteries :

To test new batteries:

1. Charge the batteries for 48 hours.
2. Press any button to activate the menu options.
3. Select Control then Start battery test. The UPS starts a battery test if the batteries are fully charged, the UPS is in Normal mode with no active alarms, and the bypass voltage is acceptable. During the battery test, the UPS transfers to Battery mode and discharges the batteries for 10 seconds. The front panel displays "Battery test in progress" and the percentage of the test completed.

7.5 Recycling the used equipment

Contact your local recycling or hazardous waste center for information on proper disposal of the used equipment.
eaton.com/recycling



Do not dispose the battery or batteries in a fire. Batteries may explode. Proper disposal of batteries is required. Refer to your local codes for disposal requirements.



Do not open or mutilate the battery or batteries. Released electrolyte is harmful to the skin and eyes. It may be toxic. Do not discard the UPS or the UPS batteries in the trash. This product contains sealed, lead acid batteries and must be disposed of properly. For more information, contact your local recycling/reuse or hazardous waste center.



Do not discard waste electrical or electronic equipment (WEEE) in the trash. For proper disposal, contact your local recycling/reuse or hazardous waste center.

8 Troubleshooting

The Eaton 9E is designed for reliable, autonomous operation while providing you with notifications and alerts whenever a potential operational or performance issue occurs.

Usually the alarms shown by the product do not mean that the output power is affected. Instead, they are preventive alarms intended to alert the user.

- Some alarms may be announced by a beep in a regular way. Example = "Battery low".
- Faults are announced by a continuous beep and red LED.



Use the following troubleshooting chart to determine the UPS alarm condition.





8.1 Typical alarms and faults

To check the Event log or Fault log:

1. Press any button on the front panel display to activate the menu options.
2. Press the down button to select Event log or Fault log.
3. Scroll through the listed events or faults.

The following table describes typical conditions:

Conditions	Possible cause	Action
Battery mode  LED is On. 1 beep every 10 seconds	A utility failure has occurred and the UPS is in battery mode.	The UPS is powering the equipment with battery power. Prepare your equipment for shutdown.
Battery low  LED is On. 1 beep every 3 seconds	The UPS is in Battery mode and the battery is running low.	This warning is approximate, and the actual time to shutdown may vary significantly. Depending on the UPS load and number of Extended Battery Modules (EBMs), the "Battery Low" warning may occur before the batteries reach 20% capacity.
No battery  LED is On Beep continuous	The batteries are disconnected.	Verify that all batteries are properly connected. If the condition persists, contact your service representative.

Conditions	Possible cause	Action
Battery fault  LED is On. Beep continuous	The battery test is failed due to bad or disconnected batteries.	Verify that all batteries are properly connected. If the condition persists, contact your service representative.
The UPS does not provide the expected backup time.	The batteries need charging or service.	Apply utility power for 48 hours to charge the batteries. If the condition persists, contact your service representative.
Bypass mode  LED is on.	An overload or a fault has occurred, or a command has been received and the UPS is in Bypass mode.	Equipment is powered but not protected by the UPS. Check for one of the following alarms: overtemperature, overload or UPS failure.
Power Overload  LED is On	Power requirements exceed the UPS capacity (greater than 100% of nominal; see "User Settings" for specific output overload ranges).	Remove some of the equipment from the UPS. The UPS continues to operate, but may shut down if the load increases. The alarm resets when the condition becomes inactive.
UPS overtemperature  LED is On Beep continuous	The UPS internal temperature is too high or a fan has failed. At the warning level, the UPS generates the alarm but remains in the current operating state. If the temperature rises another 10°C, the UPS shuts down.	Clear vents and remove any heat sources. Allow the UPS to cool. Ensure the airflow around the UPS is not restricted. Restart the UPS. If the condition continues to persist, contact your service representative.
The UPS does not start	The input source is not connected correctly.	Check the input and battery connections.
	The Remote Power Off (RPO) switch is active or the RPO connector is missing.	If the UPS Status menu displays the "Remote Power Off" notice, deactivate the RPO input.

8.2 Service and support

If you have any question or problem with the UPS, call Eaton or your local service representative in your country / region. Please have the following information ready when you call for service:

- Model number
- Serial number
- Firmware version number
- Date of failure or problem
- Symptoms of failure or problem
- Customer return address and contact information

If repair is required, you will be given a Returned Material Authorization (RMA) number. This number must appear on the outside of the package and on the Bill Of Lading (if applicable). Use the original packaging or request packaging from the Help Desk or distributor. Units damaged in shipment as a result of improper packaging are not covered by warranty. A replacement or repair unit will be shipped freight prepaid for all warranted units.



For critical applications, immediate replacement may be available. Call the Help Desk for the dealer or distributor nearest you.

9 Specification and technical characteristics

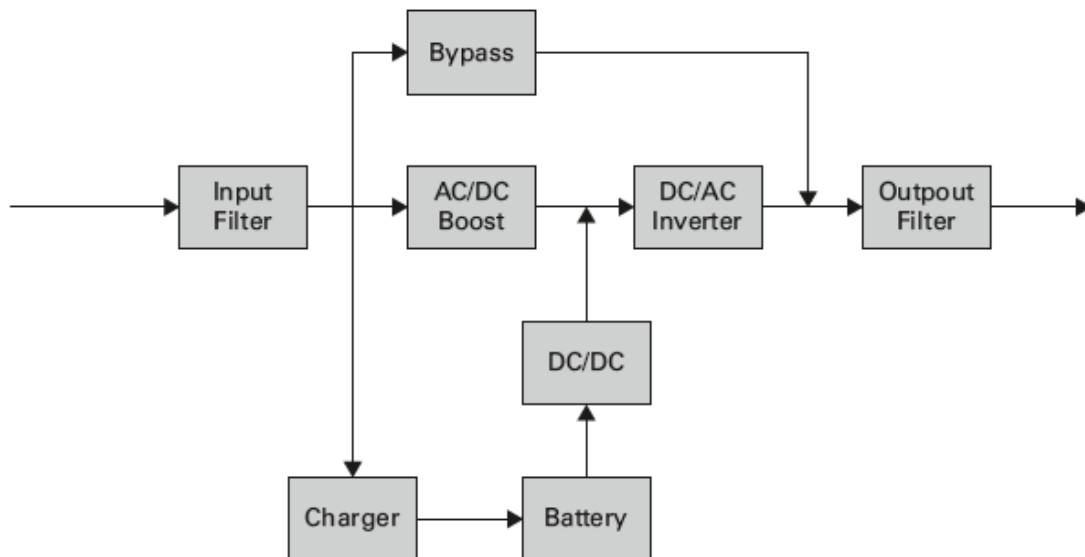

9.1 Electrical input

Default frequency	50Hz
Nominal frequency	50/60Hz
Frequency range	47-70Hz
Protective class	Protective class I

Catalog Number	Default input (Voltage/Current)	Input nominal voltages	Input voltage window
9E1000IR	230V/4.8A	200V, 208V, 220V, 230V , 240V	at 100% load: 160-276V at ≤25% load: 120-276V
9E2000IR	230V/9.4A		at 100% load: 160-276V at ≤25% load: 120-276V
9E3000IR	230V/13.7A		at 100% load: 160-276V at ≤25% load: 120-276V

9.2 Electrical output

All models	Normal mode	High Efficiency mode	Battery mode
Voltage regulation	±2%		±3%
Efficiency	>90%	>94%	82%
Frequency regulation	Sync with line ±5% of nominal line frequency (outside this range: ±0.5% of auto-selected nominal frequency)		±0.2Hz of auto-selected nominal frequency
Nominal output	200/208/220/230/240V		
Nominal Frequency	50Hz or 60Hz, autosensing or configurable as a frequency converter		
Output overload	[102-130%*] 12 sec [130-150%] 2 sec >150% Shutdown immediately		
Short circuit current limitation	Depend on the external fuse or breaker in the upstream of UPS		9E1000IR: 10A 9E2000IR: 19.2A 9E3000IR: 28.7A < 7 cycles
Voltage waveform	sin wave		
Harmonic distortion	< 3% THDV on linear load < 5% THDV on non-linear load		
Power Factor	up to 0.9		
Load crest ratio	up to 3:1		

* Percent is based on nominal Watt/VA

9.3 Battery

	Internal batteries	EBM
Specifications	9E1000IR: 36Vdc - 3 x 12V, 7Ah (9Ah max) 9E2000IR: 72Vdc - 6 x 12V, 7Ah (9Ah max) 9E3000IR: 72Vdc - 6 x 12V, 9Ah	9EEBM72R: 72Vdc - 2 string of 6 x 12V, 18Ah
Type	Sealed, maintenance-free, valve-regulated, lead-acid, with minimum 3-5 year float service life at 25°C (77°F).	

9.4 Environmental and safety

Standards	IEC/EN 62040-1 Safety IEC/EN 62040-2 Electromagnetic Compatibility EMC IEC/EN 62040-3 Performance
EMC (Emissions)	CISPR32 Class B (for output cable < 10m) IEC/EN 61000-3-2 Flickers IEC/EN 61000-3-3 Harmonics
EMC (Immunity)	IEC 61000-4-2, (ESD): 8 kV Contact Discharge / 15 kV Air Discharge IEC 61000-4-3, (Radiated field): 10 V/m IEC 61000-4-4, (EFT): 4 kV IEC 61000-4-5, (Surges): 2 kV Differential Mode / 4 kV Common Mode IEC 61000-4-6, (Electromagnetic field): 10 V IEC 61000-4-8, (Conducted magnetic field): 30 A/m
UPS enclosure IP rating	IP20
Earthing system	This UPS can be connected to TN, TT, IT electrical supply system, same system is supplied to the load.
Operating temperature	0 to 40 °C (32 to 104 °F) in Online mode, with linear derating for altitude Note: thermal protection switches load to Bypass in case of overheating.
Storage temperature	0 to 40 °C (32 to 104 °F) with batteries -25 to 55 °C (-13 to 130 °F) without batteries
Relative humidity	0 to 96 % (without condensation)
Operating altitude	Up to 3,000 meters (9,843 ft) above sea level, no derating for 40°C (104°F) room temperature
Transit altitude	Up to 10,000 meters (32,808 ft) above sea level
Transit temperature	-25 to 55 °C (-13 to 130 °F)
Audible noise	< 50 dBA at 1 meter typical

10 Glossary

Backup time	Time during which the load can be supplied by the UPS operating on battery power.
Low-battery warning	This is a battery-voltage level indicating that battery power is low and that the user must take action before the UPS shuts down.
Load	Devices or equipment connected to the UPS output.
Normal mode(double conversion)	The normal UPS operating mode in which the AC source supplies the UPS which, in turn, provides AC power to the connected loads. (after electronic double conversion).
Normal AC source	Normal source of power for the UPS.
OVL	Overload. When the load exceeds 100% of the maximum load of the UPS.
UPS	Uninterruptible Power System.
Bypass AC source	Source supplying the bypass line. The equipment can be transferred to the by-pass line if an overload occurs on the UPS output, for maintenance or in the event of a malfunction.
EBM	Extended Battery Module
Frequency converter	Operating mode used to convert the AC power frequency between the UPS input and output (50Hz -> 60Hz or 60Hz -> 50Hz).
HE Mode	Operating mode by which the load is supplied directly by the AC source if it is within the tolerances defined by the user. This mode reduces the consumption of electrical power.