



Powering Business Worldwide

# User's and installation guide

Eaton 93E Generation 2 UPS  
100-200 kVA (380/400/415V)

P-164000848

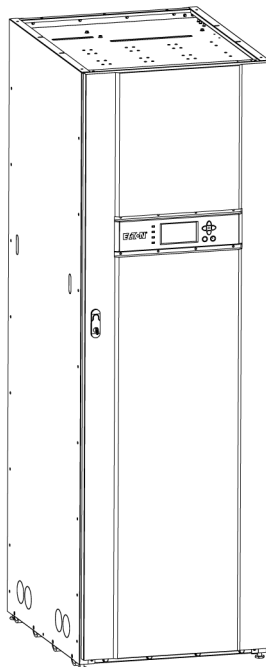

Copyright © 2018 Eaton Corporation plc. All rights reserved.

This manual contains important instructions that you should follow during installation and maintenance of the UPS and batteries. Please read all instructions before operating the equipment and save this manual for future reference.

This is a product for commercial and industrial application in the second environment. Installation restrictions or additional measures may be needed to prevent disturbances. The contents of this manual are the copyright of the publisher and may not be reproduced (even extracts) without the written approval of Eaton Corporation. Every care has been taken to ensure the accuracy of the information contained in this manual, but no liability can be accepted for any errors or omission. The right to make design modifications is reserved.

Unauthorized copying and lending are prohibited.

### Eaton Power Quality Oy

**Address:** Koskelontie 13  
FI-02920 Espoo  
FINLAND

**Internet:** [www.eaton.eu](http://www.eaton.eu)

### Approvals and version history

Revision	Date	Description of change	Approved by
001	13.11.2018	First issue	Otto Asunmaa
002	8.11.2019	Second issue	Otto Asunmaa

Original instructions  / Translation of the original instructions

# Contents

<b>1</b>	<b>How to read this manual.....</b>	<b>7</b>
1.1	Safety-related signs.....	7
1.2	Safety symbols.....	7
1.2.1	Hazard symbols.....	7
1.2.2	Prohibited action symbols.....	7
1.2.3	Mandatory action symbols.....	8
1.3	Conventions used in this document.....	8
1.4	Glossary.....	8
<b>2</b>	<b>Safety instructions.....</b>	<b>10</b>
2.1	Audience.....	12
2.2	CE marking.....	12
2.3	User precautions.....	12
2.4	Environment.....	13
2.5	Symbols on the UPS and accessories.....	13
2.6	For more information.....	14
<b>3</b>	<b>Introduction to Eaton 93E 100-200 kVA generation 2 UPS.....</b>	<b>15</b>
3.1	UPS system overview.....	17
3.2	Single UPS operating modes.....	18
3.2.1	Double conversion (normal) mode.....	19
3.2.2	High-efficiency mode.....	21
3.2.3	Bypass mode.....	21
3.2.4	Stored energy mode.....	23
3.3	UPS features.....	25
3.3.1	Installation features.....	25
3.3.2	Control panel.....	25
3.3.3	Customer interface.....	25
3.3.4	High-efficiency mode.....	25
3.3.5	Advanced Battery Management.....	26
3.3.6	Power conditioner.....	26
3.3.7	Frequency converter.....	26
3.4	Options and accessories.....	27
3.4.1	External battery cabinet.....	27
3.4.2	Tie cabinet (system parallel module).....	27
3.4.3	Parallel system.....	27
3.4.4	Monitoring and communication.....	27
3.4.5	Maintenance bypass switch.....	28
3.4.6	24 V Battery shunt trip (OVT).....	28
3.5	Battery system.....	28
3.6	Basic system configurations.....	28

3.7	Single UPS unit system online configurations.....	28
<b>4</b>	<b>UPS installation plan and unpacking.....</b>	<b>31</b>
4.1	Creating an installation plan.....	31
4.2	Installation checklist.....	32
4.3	Site preparations.....	33
4.3.1	Environmental and installation considerations.....	33
4.3.2	UPS system power wiring preparations.....	41
4.3.3	UPS system interface wiring preparation.....	47
4.4	Unpacking and unloading the UPS.....	48
<b>5</b>	<b>UPS system installation.....</b>	<b>55</b>
5.1	Installing UPS external battery cabinet and battery power cabling.....	55
5.2	External power wiring installation.....	57
5.3	Installing interface connections.....	62
5.3.1	Installing signal input connections.....	62
5.3.2	Installing parallel pull chain and CAN control wiring and connections.....	64
5.3.3	Installing MiniSlot interface connections.....	67
5.3.4	Installing external battery breaker and +24 V battery shunt trip (OVT).....	68
5.4	Installing a remote EPO switch.....	68
5.5	Initial startup.....	71
5.6	Completing the installation checklist.....	71
<b>6</b>	<b>Communication interfaces.....</b>	<b>73</b>
6.1	MiniSlot cards.....	73
6.2	Signal input (Building alarm) monitoring.....	74
<b>7</b>	<b>UPS operating instructions.....</b>	<b>75</b>
7.1	UPS controls and indicators.....	75
7.2	Using the control panel.....	77
7.2.1	Status indicators.....	78
7.2.2	System events.....	79
7.2.3	Using the LCD and push buttons.....	80
7.2.4	Using the menu.....	81
7.2.5	Mimic screen.....	81
7.2.6	Display menu operation.....	82
7.2.7	System controls.....	86
7.3	Operating a single UPS .....	88
7.3.1	Starting the UPS system in the double conversion (default) mode.....	88

7.3.2	Starting the UPS in the bypass mode.....	89
7.3.3	Transferring from the double conversion mode to the bypass mode.....	90
7.3.4	Transferring from the bypass mode to the double conversion mode .....	90
7.3.5	Transferring from the double conversion mode to the HE mode.....	91
7.3.6	Transferring from the HE mode to the double conversion mode .....	91
7.3.7	Transferring from normal operation modes to internal maintenance bypass (optional on 100-120 kVA)...	91
7.3.8	Transferring from internal maintenance bypass to normal mode (optional on 100-120 kVA).....	92
7.3.9	Shutting down the UPS system and critical load.....	92
7.3.10	Charger control.....	93
7.3.11	Battery test.....	93
7.3.12	Using the UPS LOAD OFF command.....	94
7.3.13	Using the remote emergency power-off switch.....	94
7.4	Multiple UPS parallel operation.....	95
7.4.1	Starting the parallel UPS in the double conversion mode (default mode).....	96
7.4.2	Starting the parallel UPS in the bypass mode.....	97
7.4.3	Transferring from the double conversion mode to the bypass mode.....	98
7.4.4	Transferring from the bypass mode to the double conversion (normal) mode.....	98
7.4.5	Shutting down a single UPS.....	98
7.4.6	Starting a single UPS.....	99
7.4.7	Shutting down the UPS system and critical load.....	100
7.4.8	Using the UPS LOAD OFF command.....	100
<b>8</b>	<b>UPS maintenance.....</b>	<b>102</b>
8.1	Important safety instructions.....	102
8.2	Performing preventive maintenance.....	103
8.2.1	Daily maintenance.....	103
8.2.2	Monthly maintenance.....	103
8.2.3	Periodic maintenance.....	104
8.2.4	Annual maintenance.....	104
8.2.5	Battery maintenance.....	105
8.3	Recycling the used UPS or batteries.....	105
8.4	Maintenance training.....	106
<b>9</b>	<b>Technical data.....</b>	<b>107</b>
9.1	Model numbers.....	107
9.2	UPS system input.....	107



---

9.3	UPS system output.....	108
9.4	UPS environmental specifications.....	109
9.5	Directives and standards.....	110
<b>10</b>	<b>Warranty.....</b>	<b>111</b>
10.1	General.....	111
10.2	Whom to contact in case of Warranty.....	112
<b>11</b>	<b>Appendix A: Recommended secure hardening guidelines.....</b>	<b>113</b>

# 1 How to read this manual

## 1.1 Safety-related signs

The following table explains the safety-related signs used in this document.

 <b>DANGER</b>	<b>DANGER</b> indicates a hazard with a high level of risk which, if not avoided, will result in serious injury or death.
 <b>WARNING</b>	<b>WARNING</b> indicates a hazard with a medium level of risk which, if not avoided, could result in serious injury or death, or damage to your machine.
 <b>CAUTION</b>	<b>CAUTION</b> indicates a hazard with a low level of risk which, if not avoided, could result in minor or moderate injury, or damage to your machine.







**Note:** Notes are used to indicate important information and useful tips.

## 1.2 Safety symbols



### 1.2.1 Hazard symbols

These symbols indicate a hazardous situation or action. Symbols are used to warn of situations, which may cause environmental damage and personal injury.

	General warning sign		Explosion and fire hazard
	Electrical hazard		Corrosive hazard
	Battery hazard		



### 1.2.2 Prohibited action symbols

These symbols are used to indicate an action that should not be taken.

	General symbol for prohibited action		No smoking
	Limited or restricted access		

### 1.2.3 Mandatory action symbols

These symbols are used to indicate an action that must be taken.

	General symbol for mandatory action		Disconnect from power source
	Read the manual or instructions		

## 1.3 Conventions used in this document

This document uses the following type conventions:

- **Bold type** highlights important concepts in discussions, key terms in procedures and menu options, or represents a command or option that you type or enter at a prompt.
- *Italic type* highlights notes and new terms when they are defined.
- **Screen type** represents information that appears on the screen or LCD.

## 1.4 Glossary

This document uses the following acronyms to refer to Eaton UPS products or their parts.

Table 1: Glossary of acronyms

<b>ABM</b>	Advanced Battery Management
<b>BIB</b>	Bypass Input Breaker
<b>BIS</b>	Bypass Input Switch
<b>EBC</b>	External Battery Cabinet



<b>EMBS</b>	External Maintenance Bypass Switch
<b>EPO</b>	Emergency Power-off
<b>HE</b>	High-efficiency mode
<b>IPM</b>	Intelligent Power Manager
<b>IPP</b>	Intelligent Power Protector
<b>MBP</b>	Maintenance Bypass
<b>MBS</b>	Maintenance Bypass Switch
<b>MCB</b>	Miniature Circuit Breaker
<b>MIS</b>	Maintenance Isolation Switch
<b>MOB</b>	Module Output Breaker
<b>REPO</b>	Remote Emergency Power-off terminals
<b>RIB</b>	Rectifier Input Breaker
<b>RIS</b>	Rectifier Input Switch
<b>SCR</b>	Silicon-controlled Rectifier
<b>STSW</b>	Static Switch
<b>UPS</b>	Uninterruptible Power Supply

## 2 Safety instructions



### DANGER

Important safety instructions!  
Save these instructions!

This document contains important instructions that must be followed during the installation, operation and maintenance of the UPS and the batteries. Read all of the instructions before operating the equipment. Keep this manual for future reference. These instructions are also available for download at [www.eaton.eu](http://www.eaton.eu).



### DANGER

Operations inside the UPS must be performed by an authorized Eaton Field Service Engineer or by other qualified service personnel authorized by Eaton. There are no user-serviceable parts inside the UPS.

The UPS operates with mains, battery or bypass power. It contains components that carry high currents and voltage. A properly installed enclosure is earthed and IP20 rated against electrical shock and foreign objects. However, the UPS is a sophisticated power system and only qualified personnel are allowed to install and service it.



### DANGER

This UPS carries lethal voltages. All repairs and service must be performed by authorized personnel only. There are no user-serviceable parts inside the UPS.



### WARNING

The UPS is powered by its own energy source (batteries). The output terminals may be energized even when the UPS is disconnected from an AC source. To reduce the risk of fire or electric shock, install this UPS in a temperature and humidity controlled, indoor environment that is free of conductive contaminants.

The ambient temperature must not exceed 40°C (104°F) non-condensing conditions. Do not operate the UPS near water or excessive humidity (95% relative humidity maximum). The system is not intended for outdoor use.

Before you start any installation or service work, make sure that all AC and DC power sources are disconnected. Power may come from multiple sources. Also ensure system grounding / PE continuity.

In a parallel system, the output terminals may be energized even when the UPS is turned off.

**WARNING**

Batteries present a risk of electrical shock or burn from high short-circuit current. Observe proper precautions.



Electric energy hazard. Do not attempt to alter any battery wiring or connectors. Attempting to alter wiring can cause injury.

Do not open or mutilate batteries. Released electrolyte may be toxic and is harmful to the skin and eyes.

Batteries may contain HIGH VOLTAGES, and CORROSIVE, TOXIC and EXPLOSIVE substances. Because of the battery string the output receptacles may carry high voltage even when the AC supply is not connected to the UPS. Read the shutdown instructions carefully.

**IMPORTANT:** The battery may consist of multiple parallel strings. Make sure that you disconnect all strings before installation.

**CAUTION**

Only qualified service personnel knowledgeable of batteries and the required precautions are allowed to perform installation or service work on batteries. Keep unauthorized personnel away from the batteries. Before you install or replace batteries, consider all the warnings, cautions, and notes concerning appropriate handling. Do not disconnect the batteries when the UPS is in the stored energy mode.

Make sure that your replacement batteries are of the same number and type as the battery that was originally installed in the UPS. See more accurate instructions on the UPS.

Before you connect or disconnect battery terminals, disconnect the charging source by opening the corresponding battery circuit breaker.

Check if the battery is inadvertently grounded. If it is, remove the source of the ground. Contacting any part of a grounded battery can cause a risk of electric shock. If you disconnect the grounding connection before you work on the batteries, the risk of an electric shock is less likely.

Dispose of batteries according to your local disposal requirements. Do not dispose of batteries in a fire. When exposed to flame, batteries may explode.

To reduce the risk of a fire, connect only to a circuit that has a circuit breaker that is rated in accordance with the national and local installation rules and UPS installation instructions.

To ensure proper cooling airflow and to protect personnel from dangerous voltages inside the unit, keep the UPS door closed and the front panels installed.

Do not install or operate the UPS system close to gas or electric heat sources. Keep the operating environment within the parameters stated in this document.

### CAUTION



Keep the surroundings of the UPS uncluttered, clean, and free from excess moisture.

Observe all DANGER, CAUTION, and WARNING notices affixed to the inside and outside of the equipment.

## 2.1 Audience

The intended audience of this document are as follows:

- People who plan and perform the installation of the UPS
- People who use the UPS

This document provides guidelines for how to check the UPS delivery and how to install and operate the UPS.

The reader is expected to know the fundamentals of electricity, wiring, electrical components and electrical schematic symbols. This document is written for a global reader.

### CAUTION



Read this document before you start to operate or perform work on the UPS.

## 2.2 CE marking

The product has a CE marking in compliance with the following European directives:

- LVD Directive (Safety) 2014/35/EU
- EMC Directive 2014/30/EU
- RoHS Directive 2011/65/EU

Declarations of conformity with UPS harmonized standards and directives EN 62040-1 (Safety), EN 62040-2 (EMC) and EN 50581 (RoHS) are available at [www.eaton.eu](http://www.eaton.eu) or by contacting your nearest Eaton office or authorized partner.

## 2.3 User precautions

The only permitted user operations are as follows:

- Startup and shutdown of the UPS, excluding the commissioning startup.

- Use of the LCD control panel and the maintenance bypass switch (MBS).
- Use of optional connectivity modules and their software.

Follow the precautions and only perform the described operations. Any deviation from the instructions can be dangerous to the user or cause accidental load loss.

### DANGER



Do not open any other screws in the unit than those holding the cover plates of the MiniSlots and the MBS locking plate. Failure to recognize the electrical hazards can prove fatal.

## 2.4 Environment

The UPS must be installed according to the recommendations in this document. Never install the UPS in an airtight room, in the presence of flammable gases, or in an environment exceeding the specifications.

Excessive amount of dust in the operating environment of the UPS may cause damage or lead to malfunction. Always protect the UPS from the outside weather and sunshine. In order to maximize internal battery service lifetime, the recommended operating temperature range is from +20°C to +25°C.

### WARNING





During charge, float charge, heavy discharge, and overcharge, hydrogen and oxygen gases are emitted from lead-acid and NiCd batteries into the surrounding atmosphere. Explosive gas mixture may be created if the hydrogen concentration exceeds 4% by volume in air. Ensure the necessary air flow rate for the ventilation of the UPS location.

## 2.5 Symbols on the UPS and accessories

The following are examples of symbols used on the UPS or its accessories. The symbols are used to alert you of important information.

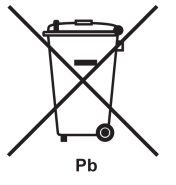
	<p><b>RISK OF ELECTRIC SHOCK</b></p> <p>Indicates that a risk of electric shock is present and the associated warning should be observed.</p>
	<p><b>CAUTION: REFER TO OPERATOR'S MANUAL</b></p> <p>Refer to your operator's manual for additional information, such as important operating and maintenance instructions.</p>

 <p>Pb</p>	This symbol indicates that you may not discard the UPS or the UPS batteries in the trash. This product involves sealed, lead-acid batteries and they must be disposed of properly. For more information, contact your local recycling / reuse or hazardous waste center.
	This symbol indicates that you may not discard waste electrical or electronic equipment (WEEE) in the trash. For proper disposal, contact your local recycling / reuse or hazardous waste center.

## 2.6 For more information

Address any inquiries about the UPS and the battery cabinet to the local office or an agent authorized by the manufacturer. Quote the type code and the serial number of the equipment.

Contact your local service representative if you need help with any of the following:

- scheduling initial startup
- regional locations and telephone numbers
- a question about any of the information in this manual
- a question that this manual does not answer



**Note:** For more information about the installation space, safe operation and working, see IEC 62485-2: Safety requirements for secondary batteries and battery installations.

## 3 Introduction to Eaton 93E 100-200 kVA generation 2 UPS

The Eaton® 93E 100-200 kVA generation 2 uninterruptible power supply (UPS) is a true online, continuous-duty, transformerless, double-conversion, solid-state, three-phase system that supplies conditioned and uninterruptible AC power to critical load and protects it from power failures.

The UPS is used to prevent loss of valuable electronic information, minimize equipment downtime, and minimize the adverse effect on production equipment due to unexpected power problems.

The Eaton UPS continually monitors incoming electrical power and removes the surges, spikes, sags, and other irregularities that are inherent in commercial utility power. Working with a building's electrical system, the UPS system supplies clean, consistent power that sensitive electronic equipment require for reliable operation. During brownouts, blackouts, and other power interruptions, batteries provide emergency power to safeguard operation.

The UPS system is housed in a single, free-standing cabinet with safety shields behind the door for protection against hazardous voltage.

Figure 7 shows the 93E 100-200 kVA generation 2 UPS.

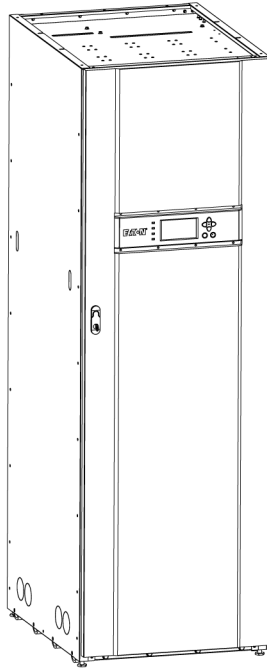

Figure 1. Eaton 93E 100-200 kVA UPS

A single UPS operates independently to support an applied load from the inverter, providing conditioned and uninterruptible AC power to the critical load from the output of the module. During an outage, the inverter continues to operate, supporting power to the load from the battery supply. If the unit requires service, applied loads are transferred to the internal bypass either automatically or manually. With the exception of an optional external battery cabinet, no other cabinets or equipment are required for the single UPS to successfully support its applied loads.



**Note:** Startup and operational checks must be performed by an authorized Eaton Field Service Engineer or by other qualified service personnel authorized by Eaton, or the terms specified in the Warranty (see Chapter 10) become void. This service is offered as part of the sales contract for the UPS. Contact service in advance (usually a two-week notice is required) to reserve a preferred startup date.



## 3.1 UPS system overview

The basic UPS system consists of a rectifier, battery converter, inverter, monitoring/operation control panel, integrated communication server, and digital signal processor (DSP) logic. Figure 2 shows the main elements of the UPS system.

If utility power is interrupted or falls outside the parameters specified in Chapter 9, the UPS uses a backup battery supply to maintain power to the critical load for a specified period of time or until the utility power returns. For extended power outages, the UPS allows you to either transfer to an alternative power system (such as a generator) or shut down your critical load in an orderly manner.

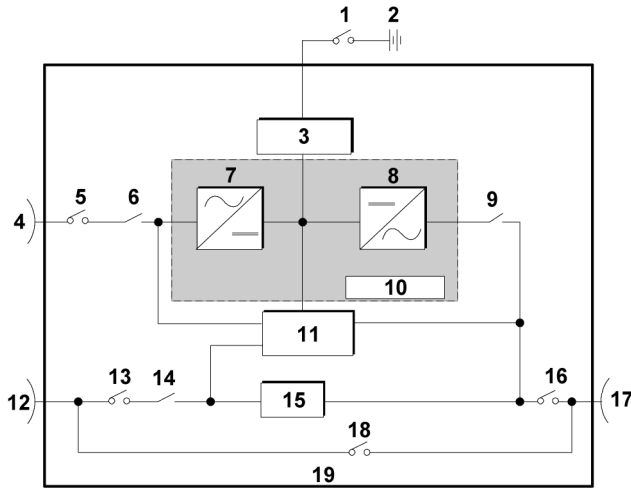

*Figure 2. Main elements of the UPS system*

- |   |  |
|---|--|
| <b>1</b> Battery breaker                | <b>11</b> Digital metering                                       |
| <b>2</b> Battery                        | <b>12</b> AC input to bypass                                     |
| <b>3</b> Battery converter power module | <b>13</b> Bypass input switch (BIS) (optional 100-120 kVA)       |
| <b>4</b> AC input to rectifier/charger  | <b>14</b> Backfeed contactor                                     |
| <b>5</b> Switch (optional 100-120 kVA)  | <b>15</b> Static switch  |
| <b>6</b> Input contactor                | <b>16</b> Output switch (optional 100-120 kVA)                   |
| <b>7</b> Rectifier                      | <b>17</b> AC output to critical load                             |
| <b>8</b> Inverter                       | <b>18</b> Maintenance bypass switch (MBS) (optional 100-120 kVA) |
| <b>9</b> Output contactor               | <b>19</b> UPS cabinet  |
| <b>10</b> Power module                  |  |

The emergency bypass consists of a continuous static switch, and an internal backfeed contactor is installed to all 93E generation 2 units sold in the EMEA market area. The backfeed protection is located in series with the static switch. The static switch is armed and ready during normal operation.

### 3.2 Single UPS operating modes

A single UPS operates independently to support an applied load from the inverter, providing conditioned and uninterruptible AC power to the critical load. During an outage, the inverter continues to operate, supporting power to the

load from the battery supply. If the unit requires service, applied loads are transferred to the internal bypass either automatically or manually. With the exception of an optional external battery cabinet, no other cabinets or equipment are required for the single UPS to successfully support its applied loads.

The UPS supports a critical load in 4 different modes of operation.

*Table 2: UPS operating modes*

UPS operating mode	Description
Double conversion mode	Critical load is supplied by the inverter, which derives its power from rectified utility AC power. In this mode, the battery charger also provides charging current for the battery. Double conversion mode is the default operation mode.
High-Efficiency (HE) mode	Commercial AC power is supplied directly to the critical load through the internal static bypass switch and transfers automatically to the double-conversion mode if an abnormal condition is detected.
Bypass mode	Critical load is supported directly by utility power through the UPS static switch.
Stored energy mode	The battery provides DC power, which maintains inverter operation. Batteries do not support the load directly. Battery converter supplies the DC-link which provides supply for the inverter to support the critical load.

### 3.2.1 Double conversion (normal) mode

During the double conversion (normal) mode, power for the system is derived from a utility input source through the rectifier input contactor. Three-phase AC input power is converted to DC using IGBT devices to produce a regulated DC voltage to the inverter. When the battery contactor is closed, the battery is charged directly from the regulated rectifier output by buck/boost DC/DC converter, depending on the system voltage and the size of the battery string attached to the unit.

Figure 3 shows the path of electrical power through the UPS system when the UPS is operating in the double conversion (normal) mode.

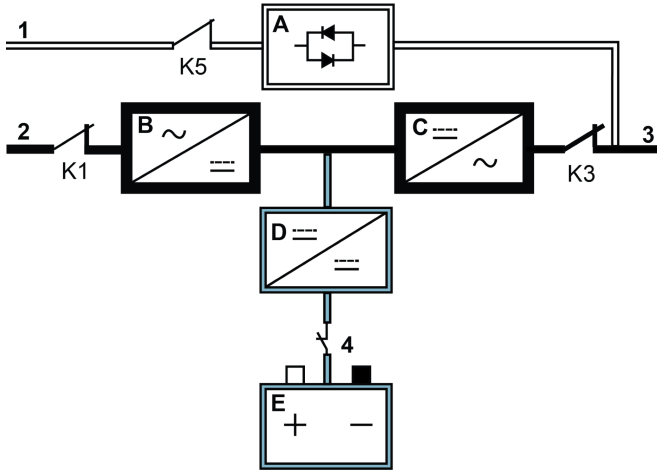

Figure 3. Path of current through the UPS in the double conversion mode

A	Static switch	1	Bypass input		Main power flow
B	Rectifier	2	Rectifier input		Energized
C	Inverter	3	Output		De-energized
D	Battery converter	4	Battery breaker		Trickle current
E	Battery		Closed		Open

The battery converter derives its input from the regulated DC output of the rectifier and provides regulated DC voltage and charge current to the battery. The battery is always connected to the UPS and ready to support the inverter should the utility input become unavailable, or supporting rectifier in the low input mains (power share) and in the overload situations.

The inverter produces a three-phase AC output to a customer's load without the use of a transformer. The inverter derives regulated DC from the rectifier, or the battery converter, and uses IGBT devices and pulse-width modulation (PWM) to produce a regulated and filtered AC output. The AC output of the inverter is delivered to the system output through the output contactor.

If the utility AC power is interrupted or is out of specification, the UPS automatically switches to the stored energy mode to support the critical load without interruption. When utility power returns, the UPS returns to the double conversion (normal) mode.

If the UPS becomes overloaded or unavailable, the UPS switches to the bypass mode. The UPS automatically returns to the double conversion (normal) mode when the overload condition is cleared and system operation is restored within specified limits.

If the UPS suffers an internal failure, it switches automatically to the bypass mode and remains in that mode until the failure is corrected and the UPS is back in service.

### 3.2.2 High-efficiency mode

When the UPS is operating in the high-efficiency (HE) mode, commercial AC power is supplied directly to the critical load through the internal bypass with the power module in a standby state. If a commercial power brownout, blackout, overvoltage, undervoltage, or out-of-tolerance frequency condition occurs the system forward transfers to the double-conversion (normal) mode, or stored energy mode. When the input line returns to normal operating range, the UPS returns to HE operation. For charging batteries in HE mode, the UPS will revert to the double-conversion (normal) mode to charge the batteries, then return to the HE mode when the charge cycle is complete.

HE mode, if selected, is a normal operating mode, and not an alarm condition. While the UPS is in this mode, the NORMAL light on the front display illuminates.

### 3.2.3 Bypass mode

#### CAUTION



The critical load is not protected from voltage or frequency fluctuations or power outages while the UPS is in the bypass mode.

The UPS automatically switches to the bypass mode if it detects an overload, load fault, or internal failure. The bypass source supplies the commercial AC power to the load directly. The UPS can also be commanded to transfer to the bypass mode manually.

Figure 4 shows the path of electrical power through the UPS system when operating in the bypass mode.

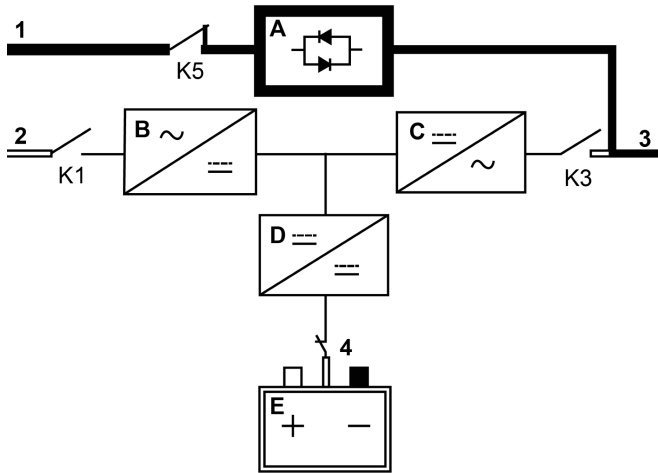

Figure 4. Path of current through the UPS in the bypass mode

A	Static switch	1	Bypass input		Main power flow
B	Rectifier	2	Rectifier input		Energized
C	Inverter	3	Output		De-energized
D	Battery converter	4	Battery breaker		Trickle current
E	Battery		Closed		Open

In the bypass mode, the output of the system is provided with three-phase AC power directly from the system input. While in this mode, the output of the system is not protected from voltage or frequency fluctuations or power outages from the source. Some power line filtering and transient protection is provided to the load, but no active power conditioning or battery support is available to the output of the system in the bypass mode.

The internal bypass is comprised of a solid-state, silicon-controlled rectifier (SCR) continuous static switch, and an internal backfeed protection contactor. The static switch is used instantaneously anytime the inverter is unable to support the applied load. The continuous static switch is wired in series with the backfeed protection contactor, and together they are wired in parallel with the rectifier and inverter.

The static switch, being an electronically-controlled device, can be turned on immediately to pick up the load from the inverter while inverter output contactor

opens to isolate the inverter. The backfeed protection contactor is normally-closed, ready to support the static switch, unless the bypass input source becomes unavailable.

If the UPS transfers to the bypass mode from the double conversion (normal) mode due to any reason other than operator intervention, the UPS automatically attempts to transfer back to the double conversion (normal) mode (up to 3 times within a 10-minute period). The 4<sup>th</sup> transfer locks the critical load to the bypass source and requires operator intervention to transfer.

### 3.2.4 Stored energy mode

The UPS automatically transfers to the stored energy mode if a utility power outage occurs, or if the utility power does not conform to specified parameters. In the stored energy mode, the battery provides emergency DC power that the inverter converts to AC power.

Figure 5 shows the path of electrical power through the UPS system when operating in the stored energy mode.

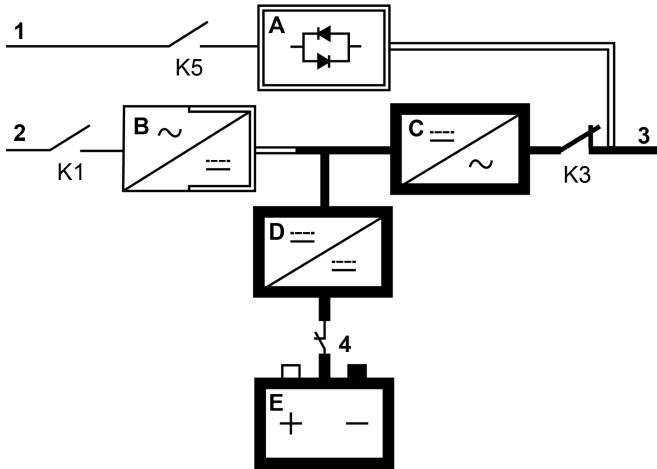

Figure 5. Path of current through the UPS in the stored energy mode

A	Static switch	1	Bypass input		Main power flow
B	Rectifier	2	Rectifier input		Energized
C	Inverter	3	Output		De-energized
D	Battery converter	4	Battery breaker		Trickle current
E	Battery		Closed		Open

During a utility power failure, the rectifier no longer has an AC utility source from which to supply the DC output voltage required to support the inverter. The input contactor opens and the battery instantaneously supplies energy to the battery converter. The converter boosts the voltage so that the inverter can support the customer's load without interruption. If bypass is common with the rectifier input, the backfeed protection contactor also opens. The opening of the input and the internal backfeed protection contactors prevent system voltages from bleeding backwards through the static switch and rectifier snubber components to the utility source.

If the input power fails to return or is not within the acceptance windows required for normal operation, the battery continues discharging until a DC voltage level is reached where the inverter output can no longer support the connected loads. When this event occurs, the UPS issues another set of audible and visual alarms indicating Shutdown imminent. Unless the rectifier has a valid AC input soon, the output can be supported for a maximum of two minutes before the



output of the system shuts down. If the bypass source is available, the UPS transfers to bypass instead of shutting down.

If at any time during the battery discharge the input power becomes available again, the input and the backfeed protection contactors close and the rectifier begins to supply DC current to the converter and inverter. At this point, the unit returns to the double conversion (normal) mode. Depending on the total load and the duration of the battery discharge, battery-related alarms may be seen for a short time due to the current required to recharge the battery.

## 3.3 UPS features

The Eaton UPS has many standard features that provide cost-effective and consistently reliable power protection. The descriptions in this section provide a brief overview of the UPS standard features.

### 3.3.1 Installation features

Power wiring can be routed to the bottom or rear of the cabinet with connections made to easily accessible terminals. Control wiring is routed through the right side of the cabinet and must be installed in accordance with Class 1 wiring methods.

### 3.3.2 Control panel

The control panel, located on the front of the UPS, contains a liquid crystal display (LCD), and push-button switches to control the operation of the UPS and to display the status of the UPS system. See Chapter 7 for more information.

### 3.3.3 Customer interface

- Signal input monitoring – Up to 3 inputs in the UPS are available to connect the alarm system contacts of the facility. Some system configurations may limit the number of inputs available. The UPS uses these inputs to monitor the signal inputs in addition to the UPS status. See Chapter 6 for additional information.
- MiniSlot communication bays – 2 communication bays are standard equipment. 1–2 optional MiniSlot connectivity cards can be installed in the UPS module at any time. MiniSlot cards are quickly installed at the front (behind the door) of the UPS and are hot-pluggable. See Chapter 6 for additional information.

### 3.3.4 High-efficiency mode

The 93E Series UPS offers a high-efficiency (HE) normal mode with double-conversion on demand that allows the UPS to operate in the standby bypass mode. This mode allows the 93E UPS to achieve 99% efficiency while still

protecting the load. See Chapter 7 for additional information on setting the UPS to work in the high-efficiency mode.

### 3.3.5 Advanced Battery Management

A 3-stage charging system increases the battery service life by optimizing the recharge time. It also protects the batteries from damage due to high current charging and inverter ripple currents.

### 3.3.6 Power conditioner

The Power Conditioner mode is characterized by the UPS running in the double-conversion mode without batteries connected. In the Power Conditioner mode, the UPS provides conditioned output voltage and frequency. The UPS can also support high, nonlinear loads without ITHD on the input. The UPS meets the qualifications outlined in this product specification, except for the conditions below.

When in the Power Conditioner mode, the UPS has the following functionality and limitations:

1. The UPS runs in the double-conversion mode.
2. Because there is no battery, loss of utility power results in the UPS losing power and shutting down.
3. The UPS sustains load until input voltage of 115 V, unless the current limit is reached.
4. If the rectifier is turned off, the UPS attempts a transfer to the bypass mode.
5. The HE mode is not available.

### 3.3.7 Frequency converter

The Frequency Converter mode is characterized by the UPS running without the bypass mode available. The output frequency can be configured to be different from the standard input frequency (e.g. 60 Hz output, 50 Hz input). The UPS can also support high, nonlinear loads without ITHD on the input. The UPS meets the qualifications outlined in this product specification, except for the conditions below.

When in the Frequency Converter mode, the UPS has the following functionality and limitations:

1. Operation is the same as when in the double-conversion mode with no bypass available.
2. Bypass alarms are suppressed.
3. Configurable output frequency range is from 50 Hz up to 60 Hz.

## 3.4 Options and accessories

Contact your Eaton sales representative for more information about the available options and accessories.

### 3.4.1 External battery cabinet

Battery backup protection is provided by equipping the UPS system with up to 4 external battery cabinets (EBCs) containing sealed lead-acid, maintenance-free batteries. An EBC is a single, free-standing cabinet designed to be installed as a part of a UPS system, but may be installed separate from the UPS cabinet.

### 3.4.2 Tie cabinet (system parallel module)

A tie cabinet provides the ability to parallel up to 4 UPSs together for increased capacity and/or redundant capability and may also include a system bypass switch. The tie cabinet is a free-standing cabinet designed to be installed separate from the UPS cabinet.

### 3.4.3 Parallel system

A parallel UPS system with up to 4 UPSs can be installed to provide a parallel capacity and/or N+1 redundant system. This load sharing system provides more capacity than a single UPS, and can provide backup, depending on the load and configuration. In addition, when one UPS is taken out of service for maintenance or is not operating properly, a redundant UPS continues to supply uninterrupted power to the critical load. A controller area network (CAN) bridge provides connectivity for system metering and operational mode control. The parallel system consists of 2 to 4 UPSs each with a parallel CAN bridge, and a tie cabinet or system parallel module to act as a tie point and to control the output.

The tie cabinet must contain module output breakers (MOBs) for each parallel UPS with dual auxiliary contacts for the control of the system. Without dual auxiliary MOBs, UPSs are not allowed to go to bypass individually during servicing. All UPSs will go to bypass instead of just the UPS needing service, decreasing critical load protection. With dual auxiliary MOBs, one UPS can be bypassed while the remaining UPSs support the load as long as the remaining UPSs have the capacity to do so. The MOBs must disconnect all 3 phases and neutral.

### 3.4.4 Monitoring and communication

Optional MiniSlot cards support several protocols, such as SNMP, HTTP, Modbus® and RS232. See Chapter 6 for additional information on monitoring and communication features.

### 3.4.5 Maintenance bypass switch

The optional internal maintenance bypass switch (MBS) for 100-120 kVA units consists of input and bypass input switches, an output switch and a maintenance bypass switch. The input and bypass input switches are used to control the AC input to the UPS. The output switch is used to control the inverter output. The MBS enables partial isolation of the UPS so that a limited number of components can be serviced without interrupting power critical systems.

### 3.4.6 24 V Battery shunt trip (OVT)

93E units are able to trip external battery breakers through 24 VDC OVT control.

## 3.5 Battery system

The battery system is in an external cabinet. The battery system provides emergency short-term backup power to safeguard operation during brownouts, blackouts, and other power interruptions. The battery system is equipped with lead-acid batteries.

## 3.6 Basic system configurations

The following basic UPS system configurations are possible:

- Single UPS with 1-4 external battery cabinets
- Single UPS with external batteries and accessory cabinets

The UPS system configuration can be enhanced by adding optional accessories such as a remote emergency power-off (remote EPO) control, or MiniSlot communication cards.

## 3.7 Single UPS unit system online configurations

The system online drawings provided in this section show the simplified internal structure of the UPS, battery supply, and basic maintenance bypass.

*Table 3: Online configurations*

Online drawing	UPS model	Input voltage	Output voltage	System type
See Figure 6	93E G2 100/100	380/400/415 VAC	380/400/415 VAC	Single reverse transfer UPS with external battery
	93E G2 120/120			
	93E G2 200/160			
	93E G2 200/200			

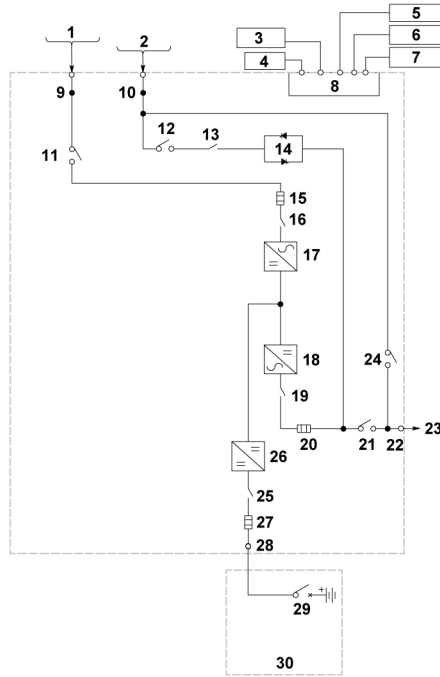

Figure 6. UPS system oneline diagram for Eaton 93E 100-200 kVA

1	AC input to UPS rec- tifier (X1)	11	Input switch (option- al 100-120 kVA)	21	Output switch (op- tional 100-120 kVA)
2	AC input to bypass (X4)	12	Bypass input switch (BIS) (optional 100-120 kVA)	22	L1, L2, L3, N, Pe
3	Pull chain	13	Backfeed contactor	23	AC output to critical load (X2)
4	Remote EPO	14	Static switch	24	Maintenance bypass switch (MBS) (option- al 100-120 kVA)
5	Parallel CAN	15	Fuse*	25	Battery contactor
6	Signal inputs (build- ing alarm)	16	Input contactor	26	Battery converter
7	MiniSlot interface	17	Rectifier	27	Fuse
8	Customer interface	18	Inverter	28	X3
9	L1, L2, L3, N, Pe	19	Output contactor	29	Battery breaker
10	L1, L2, L3, N, Pe	20	Fuse	30	External battery cabi- net

\*The fuse location depends on the UPS configuration. In 160-200 kVA units, the fuse locates between the contactor and the rectifier.

See also UPS external power cable terminations in Table [9](#).

## 4 UPS installation plan and unpacking

Use the following basic sequence of steps to install the UPS:

1. Create an installation plan for the UPS system.
2. Prepare your site for the UPS system.
3. Inspect and unpack the UPS cabinet.



**Note:** If the UPS cabinet has suffered damage during the transportation, do not continue the installation. Contact your local Eaton representatives for further actions.

4. Unload and install the UPS cabinet and wire the system.
5. Install features, accessories, or options, as applicable.
6. Complete the installation checklist provided in Section 4.2.
7. Have authorized service personnel perform the preliminary operational checks and startup.



**Note:** Startup and operational checks must be performed by an authorized Eaton Field Service Engineer or by other qualified service personnel authorized by Eaton, or the terms specified in the Warranty (see Chapter 10) become void. This service is offered as a part of the sales contract for the UPS. Contact service in advance (usually a two-week notice is required) to reserve a preferred startup date.

### CAUTION



Make sure that no power source AC or DC can accidentally be connected to the UPS during installation.

### WARNING



Installation may only be carried out by qualified technicians and in conformity with the applicable safety standards.

The UPS unit is not applicable to the IT (Isolated Terra), TT, or corner grounded power distribution system.

### 4.1 Creating an installation plan

Before you install the UPS system, read and understand how these instructions apply to the system that you are going to install. Use the procedures and illustrations in Section 4.3 and Chapter 5 to create a logical plan for installing the system.

## 4.2 Installation checklist

Table 4: Single unit installation checklist

Action	Yes / No
All packing materials and restraints are removed from each cabinet.	
The UPS cabinet is placed in its installed location.	
A readily accessible disconnect device is installed between the UPS input and utility power, in the immediate vicinity of the UPS.	
All conduits and cables are properly routed to the UPS and any ancillary cabinets.	
All power cables are properly sized and terminated.	
Neutral conductors are installed.	
Battery connection polarity is correct.	
Ground conductors are properly installed.	
(OPTIONAL) Signal inputs are wired appropriately.	
(OPTIONAL) OVT output and feedback inputs are correctly installed in external battery breaker.	
(OPTIONAL) LAN drops are installed.	
(OPTIONAL) LAN connections have been completed.	
(OPTIONAL) The remote EPO device is mounted in its installed location and its wiring is terminated inside the UPS cabinet.	
(OPTIONAL) A jumper wire is connected between pins 3 and 4 on the remote EPO terminal block if using a normally-closed remote EPO switch.	
All terminal cover plates are installed.	
(OPTIONAL) Accessories are mounted in installed locations and wiring is terminated inside the UPS cabinet.	
Air conditioning equipment is installed and operating correctly.	
The area around the installed UPS system is clean and dust-free. (Eaton recommends that the UPS be installed on a level floor suitable for computer or electronic equipment.)	
Adequate workspace exists around the UPS and other cabinets.	
Adequate lighting is provided around all UPS equipment.	
A 230 Vac service outlet is located within 7.5 metres (25 feet) of the UPS equipment.	
Startup and operational checks are performed by an authorized Eaton Customer Service Engineer or by a service engineer from an agent authorized by the manufacturer.	



Table 5: Parallel system installation checklist

Action	Yes / No
All packing materials and restraints have been removed from each cabinet.	
Each cabinet in the UPS system is placed in its installed location.	
Cable lengths from mains to UPS and from UPS to load are equal.	
All conduits and cables are properly routed to the UPSs and to the parallel tie cabinet.	
A readily accessible disconnect device is installed between the UPS input and utility power, in the immediate vicinity of the UPS.	
All power cables are properly sized and terminated.	
Neutral conductors are installed between cabinets as required.	
Ground conductors are properly installed.	
Battery terminal polarity is correct.	
CAN wiring between the UPSs is properly installed.	
Pull chain wiring between the UPSs is properly installed.	
Adequate workspace exists around the UPSs, parallel tie cabinet, and other cabinets.	
Startup and operational checks are performed by an authorized Eaton Customer Service Engineer or by a service engineer from an agent authorized by the manufacturer, for parallel systems.	

## 4.3 Site preparations

For the UPS system to operate at peak efficiency, the installation site must meet the environmental parameters outlined in these instructions. If the UPS needs to be operated at an altitude higher than 1,000 m, contact your service representative for important information about high altitude operation. The operating environment must meet the height, clearance, and environmental requirements specified.

### 4.3.1 Environmental and installation considerations

The UPS system installation must meet the following guidelines:

- The system must be installed on a level, non-combustible floor suitable for computer or electronic equipment. The floor must be suitable for heavy weight and wheeling of the UPS.
- The system must be installed in a temperature and humidity-controlled indoor area free of conductive contaminants.
- The UPS system can only be installed where there is a TN power distribution system.

- Do not expose the UPS to overly aggressive environments, like salt mist or corrosive gases. High relative humidity will accelerate the effects of contaminants. The UPS should be installed in a G1 environment (based on ANSI/ISA S-71.04 classifications). Use in a more aggressive environment can lead to reduced product life and possibly early failure. If the installation location does not meet the recommended environment, contact Eaton service representative for further information.
- The UPS should not be placed near a source of dust or sand. Excessive amount of dust or sand can cause damage or lead to malfunction.

Failure to follow guidelines may void your warranty.

The UPS equipment operating environment must meet the weight requirements in Table 6.

Table 6: UPS cabinet weights

Model	Shipping (kg)	Weight (kg) installed	Point loading
Eaton 93E G2 100/100 without batteries	351	283	35 kg per wheel (total 8 wheels)
Eaton 93E G2 120/120 without batteries	379	311	39 kg per wheel (total 8 wheels)
Eaton 93E G2 200/160 without batteries	525	457	57 kg per wheel (total 8 wheels)
Eaton 93E G2 200/200 without batteries	525	457	57 kg per wheel (total 8 wheels)

The UPS cabinet uses forced air cooling to regulate the internal component temperature. Air inlets are in the front of the cabinet and outlets are in the back of the cabinet. Allow clearance in the front and back of the cabinet for proper air circulation. The clearances required around the UPS cabinet are listed in Table 7.

Table 7: UPS cabinet clearances

	Clearance
From top of cabinet	300 mm working space
From front of cabinet	900 mm working space
From back of cabinet	> 600 mm working space recommended
From right side of cabinet	> 50 mm working space recommended
From left of cabinet	> 50 mm working space recommended

The basic environmental requirements for operation of the UPS are:

- Ambient temperature range: 0-40°C
- Recommended operating range: 20-25°C
- Maximum relative humidity: 95%, noncondensing

**Note:**

The newer, more energy efficient data center cooling methods (such as air side economization) can create much wider ranges of temperature and relative humidity (RH) in the UPS room and/or data center.

There are two aspects of this increased operating environment that can, if ignored, create issues:

One is the creation of microclimates, which are persistent variations of temperature and/or RH within a single room; for example one side of the room is always cooler than the other side, no matter what the actual temperature is.

The other aspect is the rate of change of temperature and/or RH, which can occur during transitions within the cooling system. Examples: changing the mixture ratio of inside versus outside air, or external changes in the outside air when going from nighttime into day, and back to night.

If ignored, either one of these aspects can create an undesirable microclimate at the UPS location. If the environment created by this microclimate exceeds the Eaton UPS operating specification, the UPS reliability, over time, will be reduced. These same environmental extremes will also create reliability concerns for any servers that are exposed to them.

The UPS equipment operating environment must meet the size requirements in the figures below. The dimensions are in mm(inch) format.

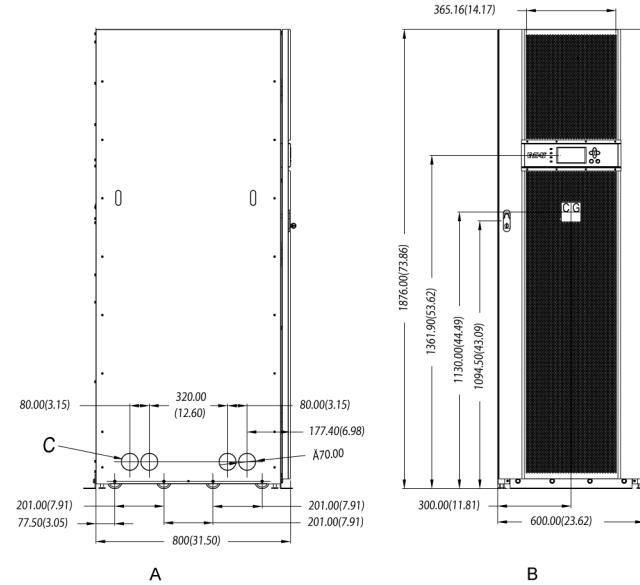

*Figure 7. UPS cabinet dimensions 93E UPS 100-120 kVA (front and left side views)*

**A** Left side view

**B** Front view

**C** Knock out holes for cable entry

**CG** Center of gravity

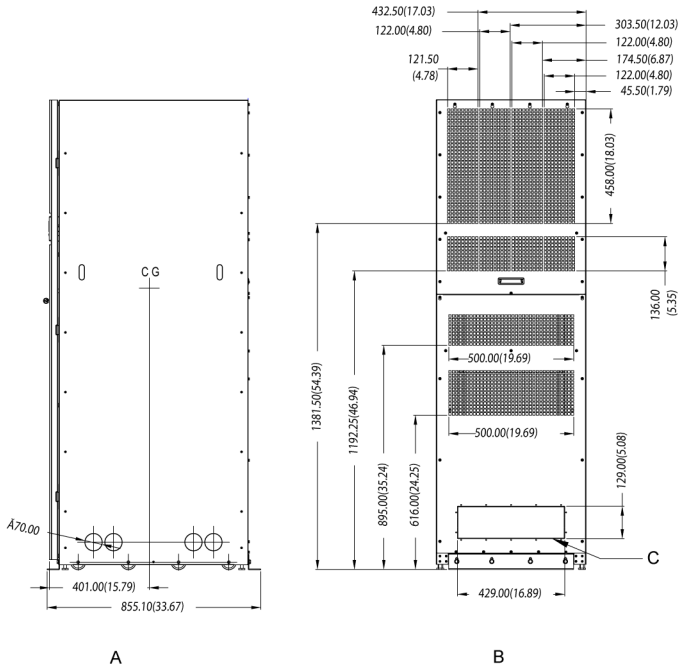

Figure 8. UPS cabinet dimensions 93E UPS 100-120 kVA (back and right side views)

**A** Right side view

**C** Rear cable access

**B** Back view

**CG** Center of gravity

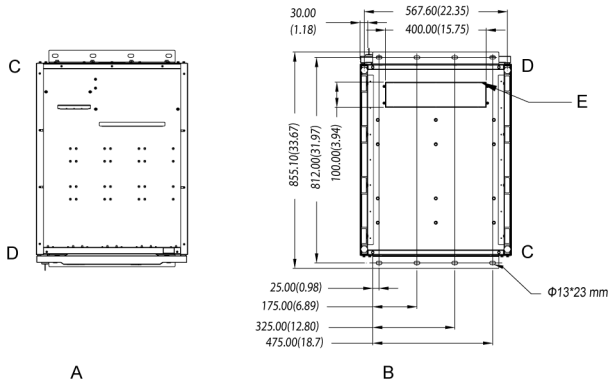

*Figure 9. UPS cabinet dimensions 100-120 kVA (top and bottom views)*

- |          |                    |          |                            |
|----------|--------------------|----------|----------------------------|
| <b>A</b> | <i>Top view</i>    | <b>D</b> | <i>Front</i>               |
| <b>B</b> | <i>Bottom view</i> | <b>E</b> | <i>Bottom cable access</i> |
| <b>C</b> | <i>Back</i>        |          |                            |

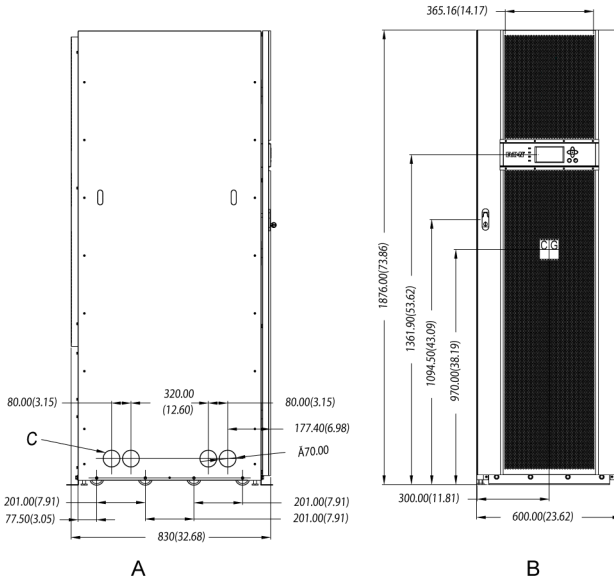

*Figure 10. UPS cabinet dimensions 93E UPS 160-200 kVA (front and left side views)*

**A** Left side view  
**B** Front view

**C** Knock out holes for cable entry  
**CG** Center of gravity

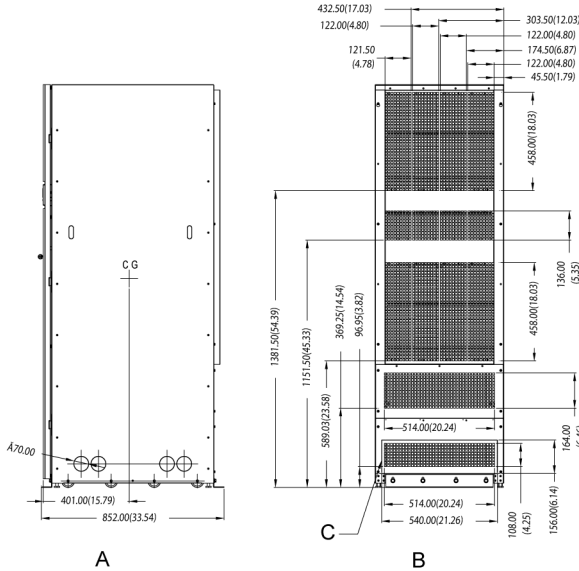

Figure 11. UPS cabinet dimensions 93E UPS 160-200 kVA (back and right side views)

**A** Right side view  
**B** Back view  
**C** Rear cable access  
**CG** Center of gravity

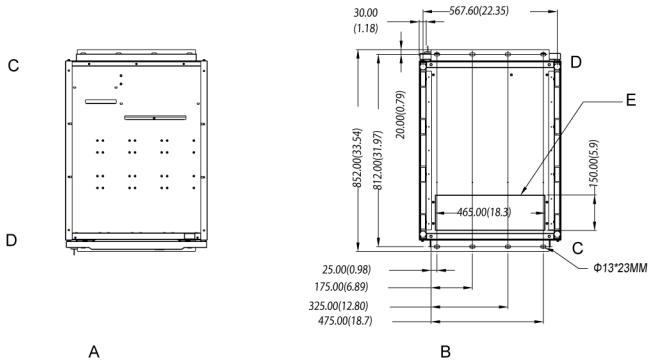

Figure 12. UPS cabinet dimensions 160-200 kVA (top and bottom views)

**A** Top view  
**B** Bottom view  
**C** Back  
**D** Front  
**E** Bottom cable access



**CAUTION**

If battery systems are located in the same room as the UPS, the environmental requirements of the battery manufacturer must be followed, if they are more stringent than the UPS requirements. Operating temperatures above the recommended range will result in decreased battery life and performance, and may reduce or void the battery warranty.

Table 8: Air conditioning or ventilation requirements during full load operation

Model	Rating	Input/output voltage	Heat rejection BTU/hr x1000 (kg-cal/hr)
Eaton 93E G2 100/100	100 kVA	380/380 VAC 400/400 VAC 415/415 VAC	23.11 (5826)
Eaton 93E G2 120/120	120 kVA	380/380 VAC 400/400 VAC 415/415 VAC	27.74 (6991)
Eaton 93E G2 200/160	160 kVA	380/380 VAC 400/400 VAC 415/415 VAC	36.99 (9322)
Eaton 93E G2 200/200	200 kVA	380/380 VAC 400/400 VAC 415/415 VAC	46.23 (11651)

#### 4.3.2 UPS system power wiring preparations

The UPS system installation must meet the following guidelines:

- The system must be installed on a level, non-combustible floor suitable for computer or electronic equipment.
- The system must be installed in a temperature and humidity controlled indoor area free of conductive contaminants.

Failure to follow guidelines may void your warranty.

The UPS equipment operating environment must meet the weight requirements shown in Table 6, and the size requirements shown in Figure 7. The dimensions are in millimeters.

**WARNING**

**HIGH TOUCH CURRENT. EARTH CONNECTION ESSENTIAL BEFORE CONNECTING SUPPLY.** As a result of the connected loads high leakage current is possible. Connection of the earth (ground) is required for proper product operation. Do not check UPS operation by removal of the Earth (ground) connection.

The UPS unit is not applicable to the IT (Isolated Terra), TT, or corner grounded power distribution systems.

### WARNING



Before working on the circuit, isolate the UPS by disconnecting all inputs and output and check for hazardous voltage between all terminals, including the protective earth.

When you plan and perform the installation, read and understand the following notes:

- Refer to the national and local electrical codes for acceptable external wiring practices.
- To allow for future kVA upgrades (software), consider using conductors that are sized for the full bypass rating of the UPS.
- For external wiring, use copper cable rated for 90°C. Wire sizes listed in Table 11 are for copper wiring only. If wire is run in an ambient temperature greater than 40°C, higher temperature wire and/or larger size wire may be necessary. Wire sizes are based on using the specified breakers.
- Material and labor for external wiring requirements must be provided by designated personnel.
- If installing an external maintenance bypass, all feeds to the UPS including the rectifier input switch (if installed) must have a service disconnect independent of the maintenance bypass power path. Most maintenance bypass solutions provide UPS input feeds derived from but isolated from the maintenance bypass power path. If the maintenance bypass solution being installed does not provide such functionality, DO NOT use a single feeder switch to supply both the UPS and the maintenance bypass.
- The bypass feed into this equipment uses five wires. The rectifier feed into this equipment uses five wires. The phases must be symmetrical about ground (from a Wye/Star source) for proper equipment operation.
- Parallel UPS input wiring size requirements and output wiring size requirements from the UPSs to the tie cabinet are the same as those for single systems.
- Install a proper three-pole overcurrent disconnect device before connecting to the UPS, the disconnect device shall disconnect simultaneously all line conductors of the AC MAINS SUPPLY.
- The UPS requires an input neutral connection. Ensure that an input neutral is connected prior to energizing the UPS. If a 4-pole automatic transfer switch is installed upstream of the UPS, it must work with a break before making transition with a minimum transfer time of 50 ms.
- Do not disconnect neutral, neutral required for system operation. If a disconnect device interrupts the neutral conductor, it shall simultaneously interrupt all line conductors.

- A readily accessible disconnect device must be incorporated in all fixed input wiring.
- When single-phase current exceeds 100A, switches of protective atmosphere should be equipped with arc-control device.

Figures 18 and 19 show the location of the UPS power cable terminals.

Table 9: UPS external power cable terminations for the Eaton 93E 100-120 kVA

Terminal function	Terminal	Function	Bus landing	Tightening torque Nm (lb in)	Bolt size and type
AC input to UPS rectifier	L1	Phase A	M8 bolt mounting	12 (106)	50.264 mm <sup>2</sup> (M8 Hex bolt)
	L2	Phase B	M8 bolt mounting	12 (106)	50.264 mm <sup>2</sup> (M8 Hex bolt)
	L3	Phase C	M8 bolt mounting	12 (106)	50.264 mm <sup>2</sup> (M8 Hex bolt)
	N	Neutral	M8 bolt mounting	12 (106)	50.264 mm <sup>2</sup> (M8 Hex bolt)
AC input to bypass	L1	Phase A	M8 bolt mounting	12 (106)	50.264 mm <sup>2</sup> (M8 Hex bolt)
	L2	Phase B	M8 bolt mounting	12 (106)	50.264 mm <sup>2</sup> (M8 Hex bolt)
	L3	Phase C	M8 bolt mounting	12 (106)	50.264 mm <sup>2</sup> (M8 Hex bolt)
	N	Neutral	M8 bolt mounting	12 (106)	50.264 mm <sup>2</sup> (M8 Hex bolt)
AC output to critical load	L1	Phase A	M8 bolt mounting	12 (106)	50.264 mm <sup>2</sup> (M8 Hex bolt)
	L2	Phase B	M8 bolt mounting	12 (106)	50.264 mm <sup>2</sup> (M8 Hex bolt)
	L3	Phase C	M8 bolt mounting	12 (106)	50.264 mm <sup>2</sup> (M8 Hex bolt)
	N	Neutral	M8 bolt mounting	12 (106)	50.264 mm <sup>2</sup> (M8 Hex bolt)
DC input from external battery	+	Battery (+)	M8 bolt mounting	12 (106)	50.264 mm <sup>2</sup> (M8 Hex bolt)
	-	Battery (-)	M8 bolt mounting	12 (106)	50.264 mm <sup>2</sup> (M8 Hex bolt)
Customer ground	Ground	Ground	M8 bolt mounting	12 (106)	50.264 mm <sup>2</sup> (M8 Hex bolt)

Table 10: UPS external power cable terminations for the Eaton 93E 160-200 kVA

Terminal function	Terminal	Function	Bus landing	Tightening torque Nm (lb in)	Bolt size and type
AC input to UPS rectifier	L1	Phase A	M10 bolt mounting	14 (124)	78.540 mm <sup>2</sup> (M10 Hex bolt)
	L2	Phase B	M10 bolt mounting	14 (124)	78.540 mm <sup>2</sup> (M10 Hex bolt)
	L3	Phase C	M10 bolt mounting	14 (124)	78.540 mm <sup>2</sup> (M10 Hex bolt)
	N	Neutral	M10 bolt mounting	14 (124)	78.540 mm <sup>2</sup> (M10 Hex bolt)
AC input to bypass	L1	Phase A	M10 bolt mounting	14 (124)	78.540 mm <sup>2</sup> (M10 Hex bolt)
	L2	Phase B	M10 bolt mounting	14 (124)	78.540 mm <sup>2</sup> (M10 Hex bolt)
	L3	Phase C	M10 bolt mounting	14 (124)	78.540 mm <sup>2</sup> (M10 Hex bolt)
	N	Neutral	M10 bolt mounting	14 (124)	78.540 mm <sup>2</sup> (M10 Hex bolt)
AC output to critical load	L1	Phase A	M10 bolt mounting	14 (124)	78.540 mm <sup>2</sup> (M10 Hex bolt)
	L2	Phase B	M10 bolt mounting	14 (124)	78.540 mm <sup>2</sup> (M10 Hex bolt)
	L3	Phase C	M10 bolt mounting	14 (124)	78.540 mm <sup>2</sup> (M10 Hex bolt)
	N	Neutral	M10 bolt mounting	14 (124)	78.540 mm <sup>2</sup> (M10 Hex bolt)
DC input from external battery	+	Battery (+)	M10 bolt mounting	14 (124)	78.540 mm <sup>2</sup> (M10 Hex bolt)
	-	Battery (-)	M10 bolt mounting	14 (124)	78.540 mm <sup>2</sup> (M10 Hex bolt)
Customer ground	Ground	Ground	M10 bolt mounting	14 (124)	78.540 mm <sup>2</sup> (M10 Hex bolt)

See also Figure 6.

Table 11: Input/Output ratings and external wiring recommendations for the Eaton 93E 100-200 kVA

Basic unit rating	Cross sections	Units	Rating 50/60 Hz			
		kVA	100	120	160	200
		kW	90	108	144	180

		Units	Rating 50/60 Hz			
Input and output voltage		Volts	400/400	400/400	400/400	400/400
AC input to UPS rectifier (0.99 Minimum pF) Full load current plus battery re-charge current (3) Phases, (1) Neutral, (1) Ground		A	150	180	240	300
Conductor size (L1, L2, L3 and N)	min.	mm <sup>2</sup>	35	50	70	95
	max.	mm <sup>2</sup>	95	120	150	240
AC input to UPS bypass (Five Wire, Dual-Feed) Full load current (3) Phases, (1) Neutral		A	144	173	231	289
Conductor size (L1, L2, L3 and N)	min.	mm <sup>2</sup>	35	50	95	185
	max.	mm <sup>2</sup>	95	120	240	240
DC input from external battery (1) Positive, (1) Negative		A	206	247	330	412
Conductor size	min.	mm <sup>2</sup>	50	70	185	300
	max.	mm <sup>2</sup>	120	150	400	400
AC output to critical load (Five Wire) Full load current (3) Phases, (1) Neutral		A	144	173	231	289
Conductor size (L1, L2, L3 and N)	min.	mm <sup>2</sup>	35	35	50	70
	max.	mm <sup>2</sup>	95	95	150	150
Grounding: - Conductor size (PE)	min.	mm <sup>2</sup>	35	50	70	95
	max.	mm <sup>2</sup>	95	120	150	240
Neutral (N) (Mains/Load: Non-linear load)	1.7 times					
Backfeed protection device	Clearance distance: ≥ 2.0 mm Break time ≤ 15 s					

See also Figure 6.



### CAUTION

Overcurrent protection is not provided by this product, but is required by codes. Refer to Table 11 for wiring requirements. If an input/output lockable disconnect is required, it is to be supplied by the user.

Rectifier input and bypass input overcurrent protection is to be provided by the user and installed in the immediate vicinity of the UPS. A readily accessible disconnect device must be incorporated in all fixed input wiring. If the optional input and bypass input switches are not chosen, input and bypass input disconnect devices are to be provided by the user and installed in the immediate vicinity of the UPS.

Output overcurrent protection and bypass and output disconnect devices are to be provided by the user and installed in the immediate vicinity of the UPS.

Table 12 lists the recommended rating for input, bypass input and output circuit breakers for rated conditional short-circuit current of 10 kA. Table 13 lists the recommended fuse types to be installed with supplies capable of providing conditional short-circuit current up to 65 kA.

Battery voltage is computed at 2 volts per cell. Rated battery current is computed at 2 volts per cell.

There is no DC disconnect device within the UPS. A battery disconnect switch is recommended, and may be required by local codes when batteries are remotely located. The battery disconnect switch should be installed between the battery and the UPS in the immediate vicinity of the UPS.

External DC input overcurrent protection and disconnect switch for a remote battery location is to be provided by the user. Table 12 lists the recommended rating for continuous-duty rated circuit breakers satisfying the criteria for both.

*Table 12: Recommended external circuit breaker ratings for rated conditional short-circuit current (Icc) of 10 kA*

Rated power	Rated voltage	Rectifier input		UPS Output/Bypass		Battery	
		Rated current	Circuit breaker rating	Rated current	Circuit breaker rating	Rated current	Circuit breaker rating
100 kVA	400 V	150	189	144	180	206	257
120 kVA	400 V	180	225	173	216	247	309
160 kVA	400 V	240	300	231	289	330	412
200 kVA	400 V	300	375	289	361	412	515

Table 13: Recommended external fuse ratings for Rated conditional short-circuit current ( $I_{cc}$ ) of 65 kA

Rated power	Rectifier input /Bypass/MBS ( $I_{cc}$ : 65 kA)	Battery ( $I_{cc}$ : 22 kA)
100 kVA	170M3420, 170M3470, 170M3520, 150M3570 (450 A/ 690 V)	170M3418, 170M3468, 170M3518, 150M3568 (350 A/ 690 V)
120 kVA	170M3422, 170M3472, 170M3522, 150M3572 (550 A/ 690 V)	170M3420, 170M3470, 170M3520, 150M3570 (450 A/ 700 V)
160 kVA	170M4417, 170M4467, 170M4517, 150M4567 (700 A/ 690 V)	170M4417, 170M4467, 170M4517, 150M4567 (700 A/ 690 V)
200 kVA	170M4417, 170M4467, 170M4517, 150M4567 (700 A/ 690 V)	170M4417, 170M4467, 170M4517, 150M4567 (700 A/ 690 V)

The battery wiring used between the battery and the UPS should not allow a voltage drop of more than 1% of nominal DC voltage at rated battery current.

### 4.3.3 UPS system interface wiring preparation

Control wiring for features and options should be connected at the customer interface terminal blocks located inside the UPS.



#### WARNING

Do not directly connect contactor contacts to the mains related circuits. Reinforced insulation is required before connecting to the mains.

Read and understand the following notes while planning and performing the installation:

- Interface wiring should be rated for 24V, 1A minimum.
- For interface wiring from 30V to 600V, the wire should be rated for 600V, 1A minimum.
- Because of the remote EPO and signal input wiring route in the UPS cabinet, the wire should be rated for a minimum of 300V.
- Use twisted-pair wires for each input and return or common.
- All interface wiring and conduit is to be supplied by the customer.
- When installing external interface wiring between a remote EPO or signal input and the UPS interface terminals, conduit must be installed between each device and the UPS cabinet.
- If using the power terminal wiring channel, keep interface wiring separate from power wiring or use shielded wire.
- Interface wiring circuits are PELV circuits.

- If using conduit, install the interface wiring in separate conduit from the power wiring.
- All signal inputs require an isolated normally-open, or normally-closed, contact or switch (rated at 24Vdc, 20 mA minimum) connected between the alarm input and common terminal. All control wiring and switch contacts are customer-supplied.
- LAN and telephone drops for use with MiniSlot connectivity cards must be supplied by the customer.
- The remote EPO feature opens all contactors in the UPS cabinet and isolates power from your critical load. Local electrical codes may also require tripping upstream protective devices to the UPS.
- The remote EPO switch must be a latching-type switch not tied to any other circuits.
- A jumper wire must be connected between pins 3 and 4 on the remote EPO terminal block if using a normally-closed remote EPO switch.
- Remote EPO wiring should be a minimum of 0.5 mm<sup>2</sup> and a maximum of 2.0 mm<sup>2</sup>.
- The remote EPO switch wiring must be in accordance with local regulations.
- The maximum distance between the remote EPO and the UPS cannot exceed 150 meters.



**Note:** The harness between OVT/feedback coil of external battery breaker and related terminal in UPS should be twisted-pair and double insulated.

## 4.4 Unpacking and unloading the UPS

Before you start to unpack and unload the UPS, carefully inspect the outer packaging for evidence of damage during transit. Do not install a damaged cabinet. Report any damage to the carrier and contact an Eaton service representative immediately.

### WARNING



The UPS cabinet is heavy. If you do not obey the unpacking instructions, the cabinet may tip over and cause serious injury.

Do not tilt the UPS cabinet more than 10 degrees from the vertical or the cabinet may tip over.

### CAUTION



Lift the cabinets only with a forklift or damage may occur.





**Note:** Verify that the forklift is rated to handle the weight of the cabinet.

For transportation purposes, the UPS cabinet is bolted onto a wooden pallet.

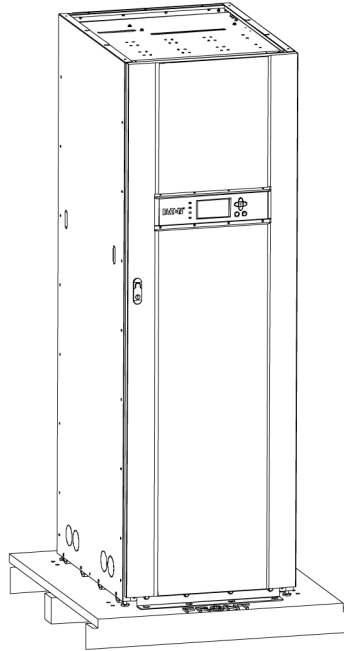

*Figure 13. UPS cabinet as shipped on pallet (wood container removed)*

To remove the pallet, do the following:

1. Before you unload the cabinet from the pallet, use a forklift or a pallet jack to move the cabinet to the installation area. Insert the forks of the forklift between the skids on the bottom of the unit.
2. Make a visual inspection and check that there are no signs of shipping damages.
3. Set the pallet on a firm, level surface, allowing a minimum clearance of 3 m on each side for removing the cabinet from the pallet.

4. Remove the protective wood container from the cabinet.  
For the following steps, use pincer type pliers or a large flat blade screw driver to straighten the securing tabs.
  - a) Straighten the tabs securing the top panel of the wooden container to the side panels of the container.
  - b) Remove the top panel.
  - c) Straighten the tabs securing the side panels of the container to the front and back panels of the container.
  - d) Remove the side panels. The side panel with sloped support blocks is designed to be used as a ramp. Retain it for later use.
  - e) Straighten the tabs securing the front and back panels of the container to the bottom of the container.
  - f) Remove the front and back panels.
5. Remove the inner protective packaging. Retain the parts kit and ramp brackets packed at the top of the cabinet.
6. Recycle the remainder of the outer shipping container and the inner protective packaging in a responsible manner.
7. Inspect the contents for any evidence of physical damage, and compare each item with the Bill of Lading. If damage has occurred or shortages are evident, contact an Eaton service representative immediately to determine the extent of the damage and its impact on further installation.



**Note:** If you do not install the UPS immediately, protect the unpacked cabinet from moisture, dust, and other harmful contaminants. Failure to store and protect the UPS properly may void your warranty.

8. Remove four bolts securing the front shipping bracket to the cabinet and four bolts securing the bracket to the pallet.
9. Remove the front shipping bracket.  
If installing the cabinet permanently, retain the shipping bracket and securing hardware for later use.

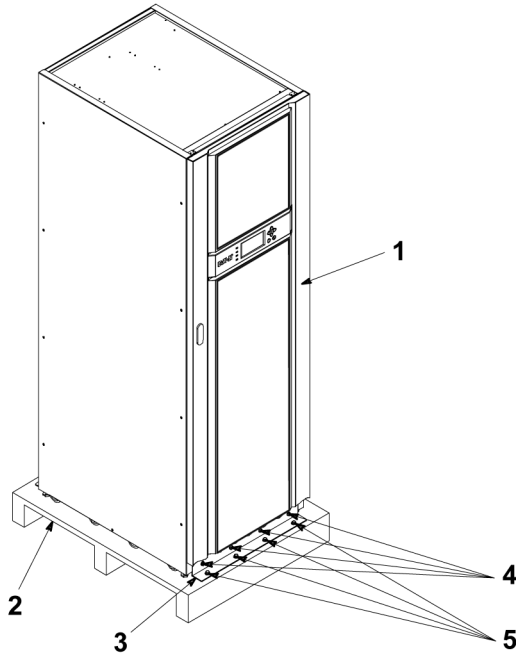

Figure 14. Removing the shipping brackets (front)

<b>1</b>	<i>Front door</i>	<b>4</b>	<i>Shipping bracket bolts</i>
<b>2</b>	<i>Pallet</i>	<b>5</b>	<i>Shipping bracket bolts</i>
<b>3</b>	<i>Shipping bracket</i>		

10. Attach the ramp to the front of the pallet
  - a) Locate the ramp (side panel with sloped support blocks from wood container), ramp extension, and ramp brackets with M10 bolts.
  - b) Place the ramp against the front of the pallet.
  - c) Attach the ramp extension to the front of the ramp by inserting the tabs on the extension into the slots at the bottom of the ramp.

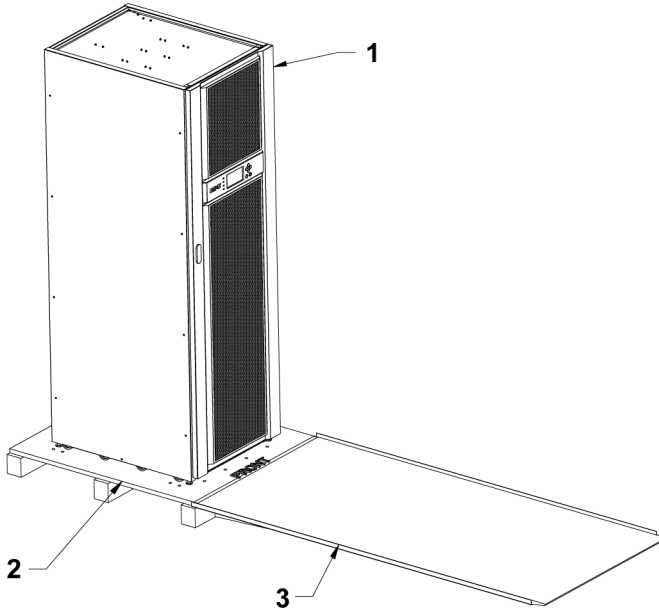

Figure 15. Attaching the ramp to the pallet

- |          |                    |          |             |
|----------|--------------------|----------|-------------|
| <b>1</b> | <i>UPS cabinet</i> | <b>3</b> | <i>Ramp</i> |
| <b>2</b> | <i>Pallet</i>      |          |             |

11. If the leveling feet are not fully retracted, turn them until they are retracted.

12. Remove the four bolts securing the rear shipping bracket to the cabinet and four bolts securing the bracket to the pallet.

13. Remove the rear shipping bracket.

If installing the cabinet permanently, retain the shipping bracket and securing hardware for later use. Otherwise, recycle the pallet, ramp, and shipping brackets in a responsible manner.

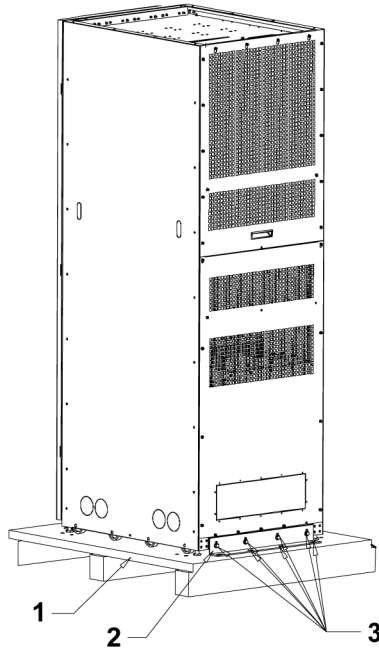

Figure 16. Removing the shipping brackets (back)

1	Pallet	3	Shipping bracket bolts
2	Shipping bracket		



### WARNING

Do not stand directly in front of the pallet while unloading the cabinet. If unloading instructions are not closely followed, the cabinet may cause serious injury.

The UPS cabinet is heavy. Two persons are needed to safely roll the cabinet down the ramp.

14. Slowly roll the cabinet toward the ramp edge. Be careful not to push the cabinet too much or too fast since it may cause the cabinet to tip over.
15. Continue rolling the cabinet down the ramp until the cabinet is clear of the ramp.
16. Roll the cabinet to its final installation location.

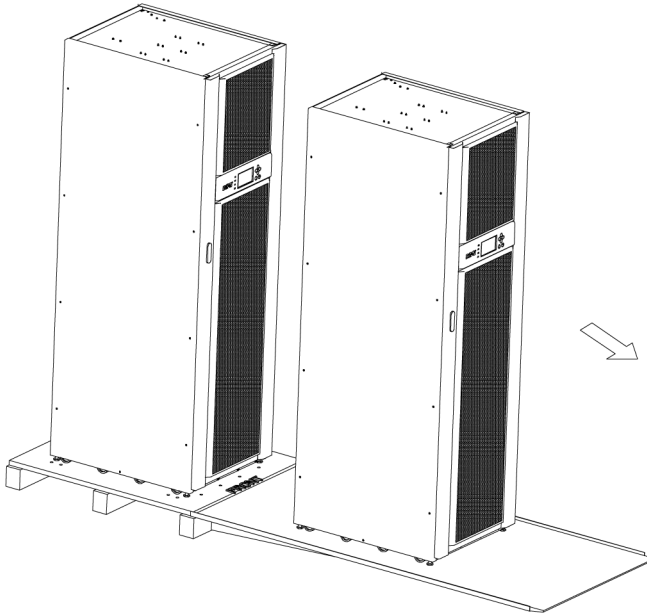
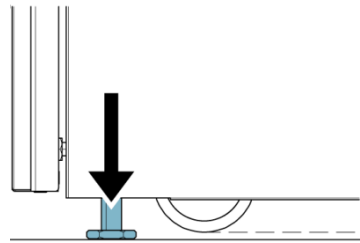

Figure 17. Rolling the cabinet down the ramp

17. To secure the UPS cabinet in position, lower the leveling feet until the cabinet is not resting on the casters and the cabinet is level.



18. If you are installing the cabinet permanently, reinstall the shipping brackets to the front and rear of the UPS cabinet to provide extra support.  
Install the shipping brackets with the angle facing outward.
19. Secure the cabinet to the floor with customer-supplied hardware.

## 5 UPS system installation

The operator has to supply the wiring to connect the UPS to the local power source. The installation of the UPS must be made by a locally qualified electrician. The electrical installation procedure is described in the following section. The installation inspection and the initial start-up of the UPS and installing an external battery cabinet must be carried out by an authorized Eaton Field Service Engineer or by other qualified service personnel authorized by Eaton.



### CAUTION

To avoid physical injury or death, or damage to the UPS or the load equipment, follow these instructions during the UPS system installation.



### WARNING

Only qualified personnel are allowed to perform the installation. See the installation instructions before connecting to the supply.

Refer to the following while installing the UPS system:

- Chapter 4 for cabinet dimensions, equipment weight, cabling and terminal data, and installation notes.
- Do not tilt the cabinets more than  $\pm 10^\circ$  during the installation.
- If perforated floor tiles are required for ventilation, place them in front of the UPS.
- The UPS unit is not suitable for IT, TT or corner-earthed power distribution systems.
- Suitable for mounting on concrete or other non-combustible surfaces only.

### 5.1 Installing UPS external battery cabinet and battery power cabling

For 93E 100-200 kVA UPS, in stored energy mode, the power is provided by external batteries. The UPS can be equipped with up to four External Battery Cabinets (EBCs) containing sealed lead-acid, maintenance-free batteries. A single EBC can contain 36, 38 or 40 batteries. Power and control wiring are not supplied with the UPS.

When installing Eaton External Battery Cabinets (EBCs), refer to the manufacturer's installation manual for installation instructions.

If installing a customer-supplied battery system, install the battery system according to the battery and battery system manufacturer's instructions and all applicable codes and regulations.

Cable entries to the UPS are on the lower back wall, and at the bottom of the cabinet.

External DC input overcurrent protection and disconnect switch for a remote battery location is to be provided by the user and installed in the immediate vicinity of the UPS.



**Note:** 24Vdc Shunt Trip signal wiring from the UPS should be connected to the auxiliary signal connection of the battery breaker.

### WARNING



In the event of malfunction, the battery cabinet chassis or battery cabinet frames may become live!

Special care should be taken when working with the battery cabinet associated with the equipment. Ensure the battery number is suited to the setting of the battery charging voltage before installing the battery. When the battery cabinet is connected the overall voltage exceeds nominal voltage. It is very important to ensure that the batteries are installed separately, in a dedicated battery cabinet.

Battery back-up time does not exceed one hour. If the battery setting must exceed one hour, consult the UPS manufacturer.

### CAUTION



The most common battery type used in UPS installations is the valve regulated battery. Valve regulated cells are not sealed. The amount of gas given off is less than for flooded cells, but when planning the battery installation, allowance must be made for adequate ventilation and heat dissipation. Valve-regulated cells are not completely maintenance-free. They must be kept clean and their connections checked periodically to ensure they are tight, and that there is no evidence of corrosion. It is inevitable that the batteries will lose charge during transportation and storage; before attempting to carry out an autonomy test, ensure that the batteries are fully charged as this may take several hours. Cell performance typically improves after a few discharge/recharge cycles.

The requirements of the EC directives are satisfied when battery cabinets are used with original accessories. If alternative batteries are used, you must ensure that the applicable EC directives are met and declare conformity.

To connect the battery cabinet:

1. Turn off the UPS.
2. Check that all the external battery breakers are open.
3. Connect PE-wire (earth) first.



4. Route cables from positive (+) and negative (-) terminals in the first battery into the UPS cabinet through the conduit (back or bottom entry) and connect the cables to terminals BAT+ and BAT-.
5. If the external battery cabinet has a control circuit, route control/feedback wires from the external battery cabinet to the UPS tripping circuit terminals. 93E-100-200kVA units support 24 V OVT functionality.

Size cables according to cable size recommendations in Table 11, and protective device specification in Table 12.

If you are installing more than one battery cabinet, the first battery cabinet will be the only cabinet directly connected to the UPS.

## 5.2 External power wiring installation



**Note:** Without accessory cabinets, conduit and wiring enter from the bottom or rear of the UPS conduit landing plate. These accessory cabinets are to be supplied by the customer.

To install the wiring:

1. Route the wiring to the UPS terminal blocks in the UPS. See Figure 20 for wiring access information and terminal locations.
2. Ground the UPS according to local and national electrical wiring codes by routing and connecting the ground wire to the input ground lug. See Figure 20 for UPS terminal locations. For a detailed view of the UPS ground terminals, see Figures 18, 19 and 20.
3. Connect phase L1, L2, L3, and neutral rectifier input power wiring from the utility source to the rectifier input and neutral terminals. See Section 4.3.2 for wiring and termination requirements. For a detailed view of the UPS terminal block, see Figures 18, 19 and 20.
4. Connect L1, L2, L3, and neutral bypass input power wiring from the utility source to the bypass input terminals and neutral terminals. For a single feed installation, jumpers between the input and bypass terminals must be installed. Mains input N and bypass input N are connected together inside UPS. See Figure 22 for wiring and termination requirements. For a detailed view of the UPS terminal block, see Figures 18, 19 and 20.
5. Connect phase L1, L2, L3, and neutral (if required) power wiring from output terminals and neutral terminals to the critical load. See Tables 9 and 11 for wiring and termination requirements. For a detailed view of the UPS terminal block, see Figures 18, 19 and 20.
6. If wiring interface connections, proceed to Section 5.3.

### WARNING

HIGH TOUCH CURRENT. EARTH CONNECTION ESSENTIAL BEFORE CONNECTING SUPPLY. As a result of the connected loads, high leakage



current is possible. Connection to earth/ground is required for safety and proper product operation. Do not install or operate the UPS without an earth/ground connection.



**Note:** If there is an input ATS for dual source input or a generator as the UPS input source, the ATS should be 3-pole. If a 4-pole ATS is used, the neutral interruption time should be less than 10 minutes.

BAT+/BAT- are terminals connected to the battery cabinet. Battery+ polarity should use a red cable, battery- polarity should use a black or blue cable.

The external battery cabinet must be earthed to the UPS.

If the UPS is not fitted with the optional internal mains disconnection device, it is essential to install an external mains disconnection device.

Input neutral line should be directly connected to the input "N" terminal of the UPS wire connection terminal bay at all times.

There are protective earthing terminals on the UPS for mains supply, load supply and battery. The battery cabinet earth protection can be connected either to the UPS or to a common earthing terminal outside the UPS.

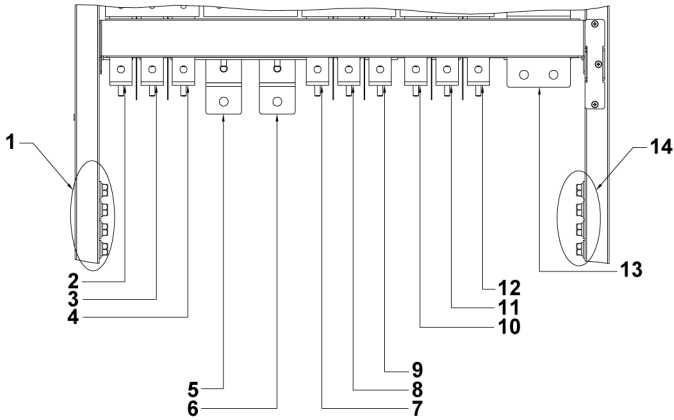

*Figure 18. Power terminal locations 100-120 kVA with MBS (front view without the terminal cover plate)*

- |   |   |
|---|---|
| <b>1</b> Earth/Ground                             | <b>8</b> AC input to UPS bypass, Phase B (L2)     |
| <b>2</b> AC output to critical load, Phase A (L1) | <b>9</b> AC input to UPS bypass, Phase C (L3)     |
| <b>3</b> AC output to critical load, Phase B (L2) | <b>10</b> AC input to UPS rectifier, Phase A (L1) |
| <b>4</b> AC output to critical load, Phase C (L3) | <b>11</b> AC input to UPS rectifier, Phase B (L2) |
| <b>5</b> DC input from external battery +         | <b>12</b> AC input to UPS rectifier, Phase C (L3) |
| <b>6</b> DC input from external battery -         | <b>13</b> Neutral (N)                             |
| <b>7</b> AC input to UPS bypass, Phase A (L1)     | <b>14</b> Earth/Ground                            |

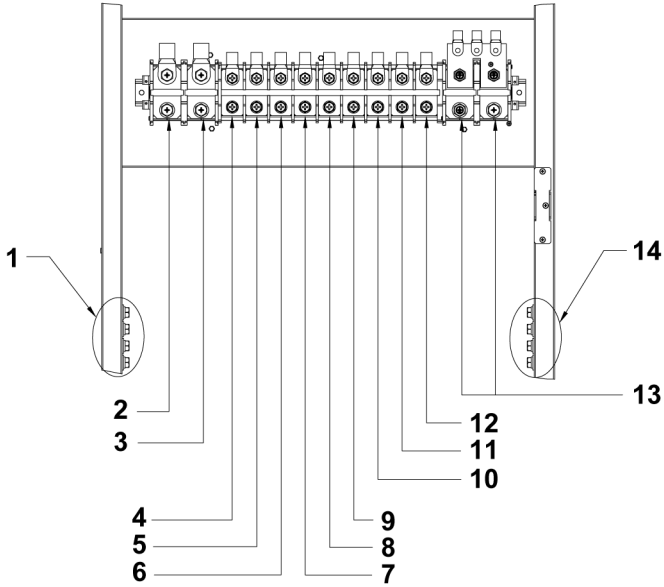

*Figure 19. Power terminal locations 100-120 kVA without MBS (front view without the terminal cover plate)*

- |   |   |
|---|---|
| <b>1</b> Earth/Ground                             | <b>8</b> AC input to UPS bypass, Phase B (L2)     |
| <b>2</b> DC input from external battery +         | <b>9</b> AC input to UPS bypass, Phase C (L3)     |
| <b>3</b> DC input from external battery -         | <b>10</b> AC input to UPS rectifier, Phase A (L1) |
| <b>4</b> AC output to critical load, Phase A (L1) | <b>11</b> AC input to UPS rectifier, Phase B (L2) |
| <b>5</b> AC output to critical load, Phase B (L2) | <b>12</b> AC input to UPS rectifier, Phase C (L3) |
| <b>6</b> AC output to critical load, Phase C (L3) | <b>13</b> Neutral (N)                             |
| <b>7</b> AC input to UPS bypass, Phase A (L1)     | <b>14</b> Earth/Ground                            |

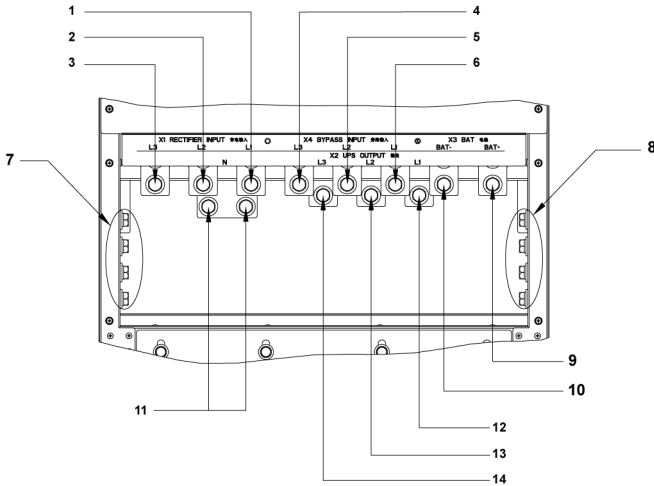

*Figure 20. Power terminal detail 160-200 kVA*

- |  |  |
|--|--|
| <b>1</b> AC input to UPS rectifier, Phase A (L1) | <b>8</b> Earth/Ground                              |
| <b>2</b> AC input to UPS rectifier, Phase B (L2) | <b>9</b> DC input from external battery +          |
| <b>3</b> AC input to UPS rectifier, Phase C (L3) | <b>10</b> DC input from external battery -         |
| <b>4</b> AC input to UPS bypass, Phase C (L3)    | <b>11</b> Neutral (N)                              |
| <b>5</b> AC input to UPS bypass, Phase B (L2)    | <b>12</b> AC output to critical load, Phase A (L1) |
| <b>6</b> AC input to UPS bypass, Phase A (L1)    | <b>13</b> AC output to critical load, Phase B (L2) |
| <b>7</b> Earth/Ground                            | <b>14</b> AC output to critical load, Phase C (L3) |

When you have finished the cable routing, use fireproof mud to block the space between the cable and cabinet.

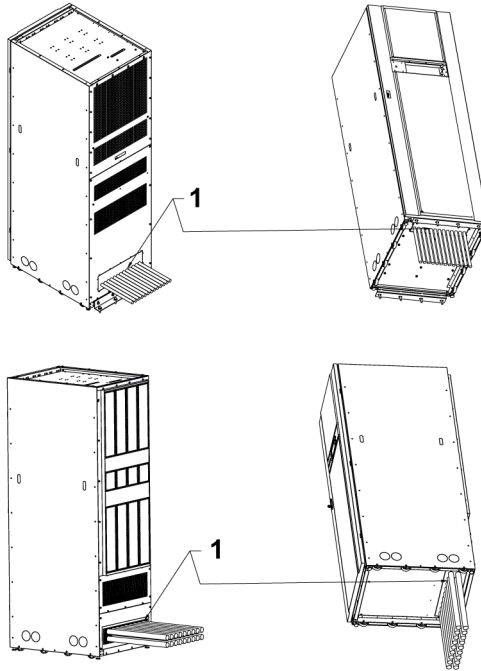

Figure 21. Blocking the space between the cable and cabinet

- 1 Space to be blocked with fireproof mud

## 5.3 Installing interface connections

### 5.3.1 Installing signal input connections

To install wiring:

1. Make sure that the UPS system is turned off and all power sources are removed. See Chapter 7 for shutdown instructions.
2. To locate the appropriate terminals and review the cabling and termination requirements, see Section 4.3.3, Table 14, Figure 22 and Figure 23.
3. Route the interface cables to the UPS via the right side panel or the knockout at the top (front right corner) of the cabinet.
4. Connect the signal input interface cabling as shown in Table 14 and Figure 23.
5. If you are cabling parallel connections, proceed to Section 5.3.2. If you are cabling MiniSlot connections, proceed to Section 5.3.3.

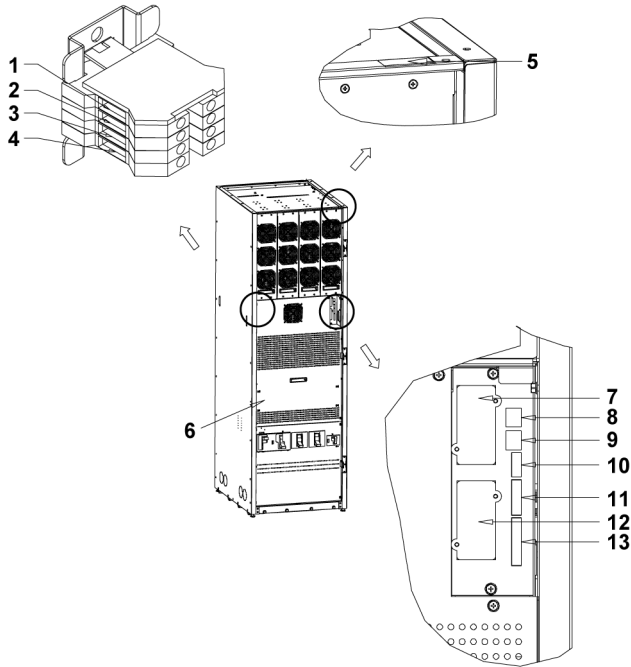

*Figure 22. Interface terminal locations*

- |          |                                     |           |  |
|----------|-------------------------------------|-----------|--|
| <b>1</b> | <b>+24V</b>                         | <b>8</b>  | <b>Parallel CAN output port (PAR OUT)</b>            |
| <b>2</b> | <b>BAT OVT</b>                      | <b>9</b>  | <b>Parallel CAN input port (PAR IN)</b>              |
| <b>3</b> | <b>FD_A</b>                         | <b>10</b> | <b>Pull chain terminals (PUL CH)</b>                 |
| <b>4</b> | <b>FD_B</b>                         | <b>11</b> | <b>Remote Emergency Power-off terminals (REPO)</b>   |
| <b>5</b> | <b>Top wiring access</b>            | <b>12</b> | <b>MiniSlot communication bay 2</b>                  |
| <b>6</b> | <b>Front middle cover plate</b>     | <b>13</b> | <b>Signal input/Building alarm terminals (BA1-3)</b> |
| <b>7</b> | <b>MiniSlot communication bay 1</b> |           |  |

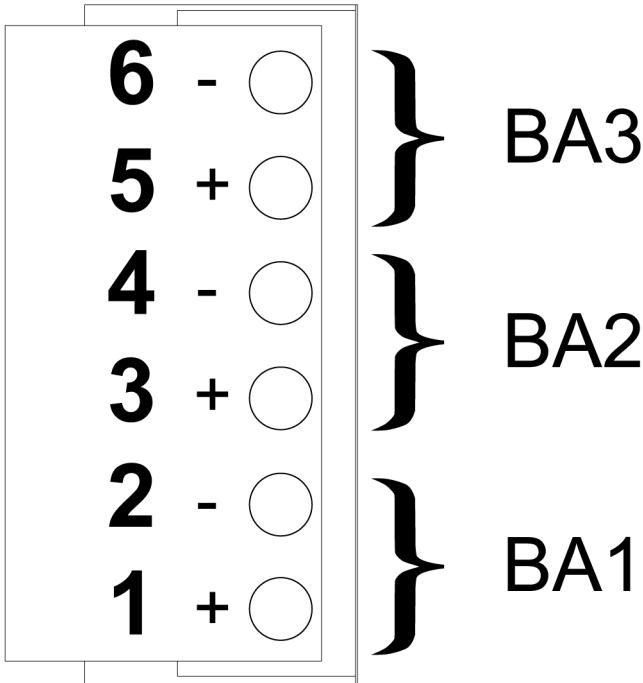

Figure 23. Signal input (building alarm) terminal block connector assignments

Table 14: Signal input connections

Signal input terminal	Name	Description
1	BA1: Signal input 1+	Input: Programmable UPS command/alarm, activated by a remote dry contact closure.
2	BA1: Signal input 1-	
3	BA2: Signal input 2+	Input: Programmable UPS command/alarm, activated by a remote dry contact closure.
4	BA2: Signal input 2-	
5	BA3: Signal input 3+	Input: Programmable UPS command/alarm, activated by a remote dry contact closure.
6	BA3: Signal input 3-	

### 5.3.2 Installing parallel pull chain and CAN control wiring and connections

To install wiring:



1. Make sure that the UPS system is turned off and all power sources are removed. See Chapter 7 for shutdown instructions.
2. For installing the parallel system, see Figure 27.

**CAUTION**



In a parallel system, the combined input and output cable length should be in accordance with the following rule. It should be designed to ensure that wiring impedance from the point of supply to the UPS input and from the UPS output to the load connection for each UPS module in a multi-module system is equal, or within a tolerance of approximately  $\pm 10\%$ . This is to ensure approximately equal current sharing when in the static bypass mode and to restrain input/output high frequency loop current of a parallel system.

Total length:  $1A + 1B = 2A + 2B = 3A + 3B = 4A + 4B$  (see Figure 27)

If you are installing only two UPS modules (redundant), this requirement is no longer required, as each UPS is capable of supporting the full bypass requirement. However, this would preclude future expansion.

Make sure that each UPS static bypass and the external bypass switch (if installed) is fed from a single common source. If each UPS is fed with a separate rectifier source, consult Eaton for advice on compatibility.

3. To locate the appropriate terminals and review the wiring and termination requirements, see Section 4.3.3, Table 15, Figure 22, and Figure 24.

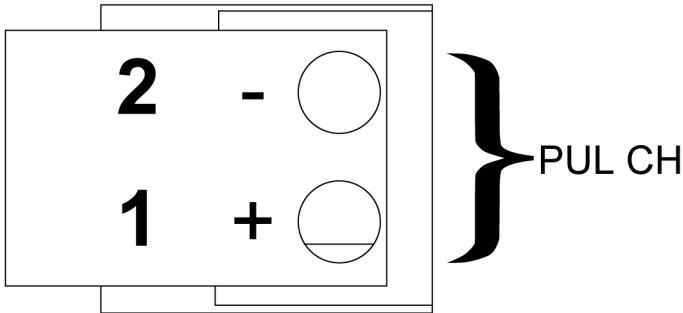
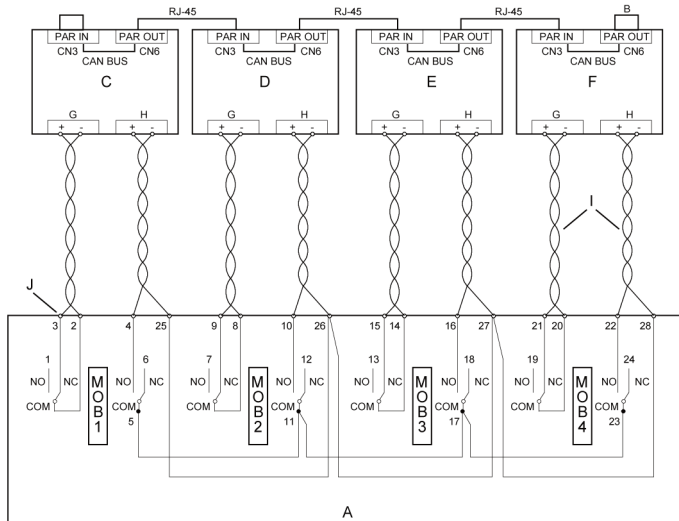

Figure 24. Pull chain terminal block connector assignments

Table 15: Pull chain connections

Pull chain terminal	Name	Description
+	Pull chain +	Output: Backup control for parallel operation.
-	Pull chain -	

4. Route the wiring to the terminal block.
  - a. Remove the small parts from the knockout in the right side plate.
  - b. Route the wiring to the wiring access, see Figure 22. Secure the wiring to the four mounting clips provided using Zip ties.
  - c. Reinstall the cover panels.
  - d. Install the power terminal cover up and down sides using the provided hardware.
5. Route and install the RJ-45 Controller Area Network (CAN) cables between the UPS cabinets. See Figures 21 and 27 for wiring information.
6. Route and install pull chain wiring (twisted wires 0.5-2.0 mm<sup>2</sup>) between the UPS cabinets and cabinet MOBs. See Figures 22 and 27 for wiring information.
7. If you are wiring MiniSlot connections, proceed to Section 5.3.3.
8. Install the power terminal cover right and left sides using the provided hardware.



*Figure 25. UPS paralleling wiring diagram – with parallel tie cabinet*

- |                             |  |
|-----------------------------|--|
| <i>A Tie cabinet</i>        | <i>F UPS 4</i>                               |
| <i>B Terminating jumper</i> | <i>G Building alarm (BA)</i>                 |
| <i>C UPS 1</i>              | <i>H Pull chain (PUL CH)</i>                 |
| <i>D UPS 2</i>              | <i>I Twisted pairs</i>                       |
| <i>E UPS 3</i>              | <i>J Customer terminal block connections</i> |

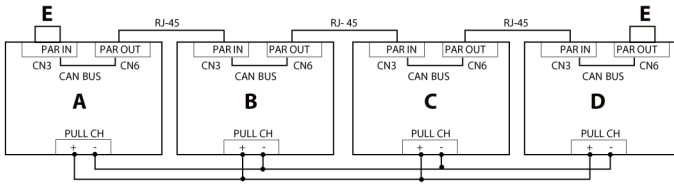

Figure 26. UPS paralleling wiring diagram – without parallel tie cabinet

- A UPS 1
- B UPS 2
- C UPS 3
- D UPS 4
- E Terminating jumper

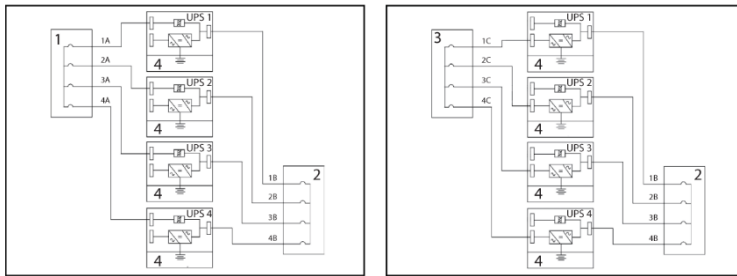

Figure 27. Parallel UPS system connections

- 1 Cabling to UPS bypass input
- 2 Outputs from UPSs
- 3 Cabling to UPS rectifier input
- 4 External battery cabinet(s)

### 5.3.3 Installing MiniSlot interface connections

For the installation and setup of a MiniSlot card, contact your Eaton representative.

To install wiring:

1. If not already installed, install the LAN drops. The LAN drop is to be supplied by the customer.
2. Route and install the LAN and other cables to the appropriate MiniSlot cards. See Figure 22.
3. For operator instructions, refer to the manual supplied with the MiniSlot card.

### 5.3.4 Installing external battery breaker and +24 V battery shunt trip (OVT)

See Figure 22 for the UPS terminal for the external battery breaker OVT-relay and breaker state information.

The battery shunt trip signals from up to down are +24V, BAT\_OVT, FD\_A and FD\_B. The +24V OVT output should connect to a battery breaker +24 V input. The BAT\_OVT output should connect to a battery breaker Trip/GND input. External battery breaker state information should be connected to the shunt trip terminals FD\_A, FD\_B.

## 5.4 Installing a remote EPO switch

A latching-type remote emergency power-off (remote EPO) switch can be used in an emergency to shut down the UPS and remove power to the critical load from a location away from where the UPS is installed.



**Note:** Before you install a remote EPO switch, make sure that the UPS was installed according to the instructions in Sections 4.4 through 5.3.

When you install the remote EPO switch, install a conduit between the device and the UPS cabinet for wiring the switch.

The remote EPO switch must be a normally-open or normally-closed latching-type switch that is not tied to any other circuits.

This procedure is intended for installing the Eaton-supplied remote EPO switch. If you are installing another manufacturer's switch, use this procedure, and Figure 29 and Figure 30 as a guide.

Make sure that the wiring of the remote EPO switch is in accordance with local regulations.

To install a remote EPO switch:

1. Make sure that the UPS system is turned off and all power sources are removed. See Chapter 7 for shutdown instructions.
2. Mount the remote EPO switch securely. Recommended locations for the remote EPO switch include the operator's consoles or near exit doors.
3. To locate the appropriate terminals and review the wiring and termination requirements, see Section 4.3.3, Table 16, and Figures 22 and 28.

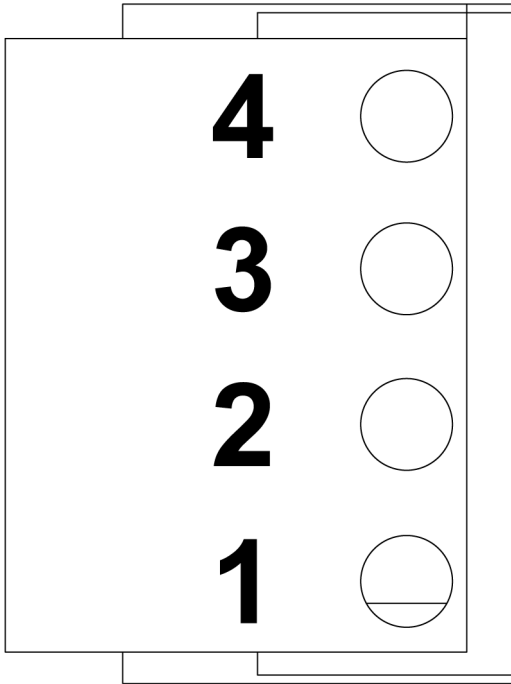

Figure 28. Remote EPO (REPO) terminal block connector assignments

Table 16: Remote EPO connections

Remote EPO terminal	Description
1	Input: a normally-closed dry contact used to activate UPS EPO from a remote switch.
2	
3	Input: a normally-open dry contact used to activate UPS EPO from a remote switch.
4	

4. Route the remote EPO wiring to the terminal block, see Figure 22.
5. Connect the wiring as shown in Table 17 and Figure 29 for a normally-open remote EPO or Table 18 and Figure 30 for a normally-closed remote EPO.
6. If you are using a normally-closed remote EPO switch, connect a jumper wire between pins 3 and 4 on the remote EPO terminal block.
7. If you are installing multiple remote EPO switches, wire the additional switches in parallel with the first remote EPO.
8. If required, install wiring from the remote EPO switch to the trip circuitry of the upstream protective devices. A second contact block is provided on the

remote EPO switch for this function. Make sure that the wiring of the remote EPO switch is in accordance with local regulations.

*Table 17: Normally-open remote EPO wire connections*

From remote EPO station(s) switch contact block (either contact)	To remote EPO terminal block on the back of UPS cabinet	Wire size	Tightening torque
3 N.O. 3	See Figure 29 for wiring	Twisted wires (2) (0.5 -2.0 mm <sup>2</sup> )	0.8 Nm
4 N.O. 4			

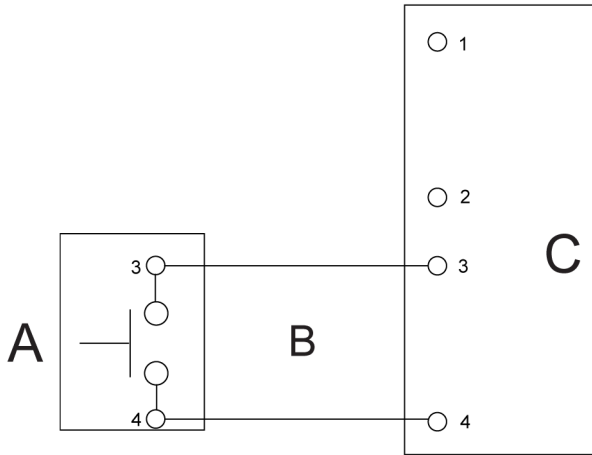

*Figure 29. Normally-open remote EPO switch wiring*

- A Remote EPO switch (N.O.)
- B Twisted wires
- C UPS Remote EPO terminal (REPO)

*Table 18: Normally-closed remote EPO wire connections*

From remote EPO station(s) switch contact block (either contact)	To remote EPO terminal block on the back of UPS cabinet	Wire size	Tightening torque
1 N.C. 1	See Figure 30 for wiring	Twisted wires (2) (0.5 -2.0 mm <sup>2</sup> )	0.8 Nm
2 N.C. 2			

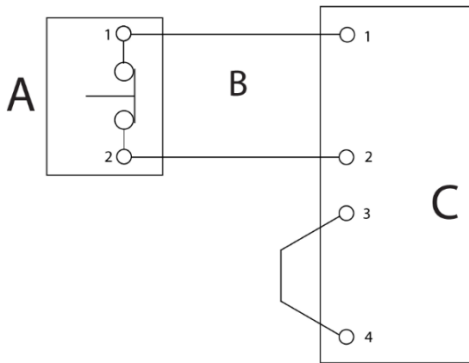

Figure 30. Normally-closed remote EPO switch wiring

- A Remote EPO switch (N.C.)      C UPS Remote EPO terminal (REPO)  
B Twisted wires

## 5.5 Initial startup

Startup and operational checks for a single UPS installation must be performed by an authorized Eaton Customer Service Engineer or other qualified service personnel such as a licensed service engineer from an agent authorized by the manufacturer.

Startup and operational checks for parallel systems or installations with accessory cabinets must be performed by an authorized Eaton Customer Service Engineer, or the warranty terms specified in Chapter 10 become void. This service is offered as part of the sales contract for the UPS. Contact an Eaton service representative in advance (usually a two-week notice is required) to reserve a preferred startup date.

## 5.6 Completing the installation checklist

The final step in installing the UPS system is completing the installation checklist, see Section 4.2. This checklist ensures that you have completely installed all the hardware, cables, and other equipment. Complete all the items listed in the checklist to ensure a smooth installation. Make a copy of the installation checklist before filling it out, and retain the original.

After the installation is completed, an Eaton Customer Service Engineer must verify the operation of the UPS system and commission it to support the critical load. The service representative cannot perform any installation tasks other than verifying the software and the operating setup parameters. Service personnel may request a copy of the completed installation checklist to verify that all the applicable equipment installations have been completed.



**Note:** The installation checklist must be completed prior to starting the UPS system for the first time.



## 6 Communication interfaces

This section describes the communication features of Eaton 93E UPS - generation 2. For terminal wiring information, see Sections [4.3.3](#) and [5.2](#). For the location of the customer interface panel and terminals, see [Figure 22](#).

### 6.1 MiniSlot cards

The UPS is compatible with the following MiniSlot cards:

- **Gigabit Network Card (NETWORK-M2)**  
Enhances the capabilities and protection provided by the UPS by enabling Web and SNMP based remote monitoring and e-mail alarms. The card also enables shutdown of servers and migration of virtual machines through IPM and IPP software. Supports 10/100 Mbit and Gigabit Ethernet.

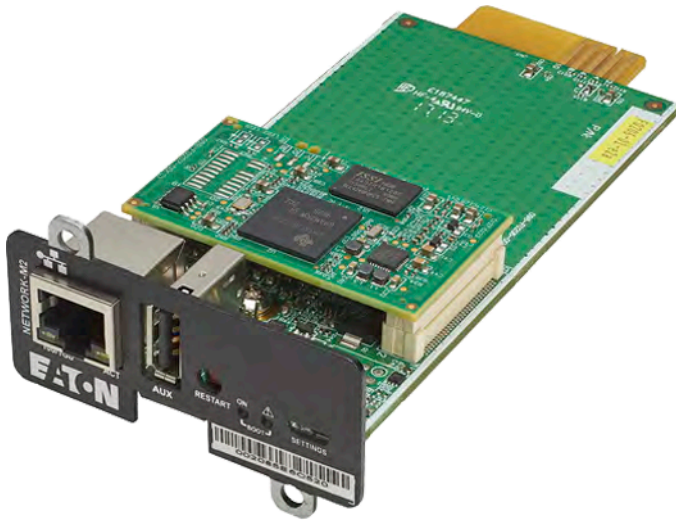

*Figure 31. Gigabit Network Card*

- **Industrial Gateway Card (INDGW-M2)**  
This card has all the features and capabilities of the Gigabit Network Card. In addition, it also provides direct integration of system level UPS information (meters and status) to a Building Management System (BMS) using the Modbus RTU and Modbus/TCP.



Figure 32. Industrial Gateway Card

## 6.2 Signal input (Building alarm) monitoring

This standard feature lets you connect additional monitoring to the UPS, such as smoke detectors or over-temperature alarms to your signal inputs. The user interface terminals for external connections are located inside the UPS. Use twisted-pair wires for each alarm input and common.

The signal inputs can be programmed to display the alarm functional name.

## 7 UPS operating instructions

This section describes how to operate the UPS.



### CAUTION

Before you operate the UPS, make sure that all the installation tasks are completed and a preliminary startup has been performed by authorized service personnel. The preliminary startup verifies all the electrical interconnections to make sure that the installation was successful and the system operates properly.

Before you operate any of the controls, read these instructions and have a thorough understanding of the UPS operation.

### 7.1 UPS controls and indicators

The controls and indicators identified and described in this section are used to control and monitor the UPS operation. Figure 33 shows the controls and indicators and Figure 34 shows the UPS switches.

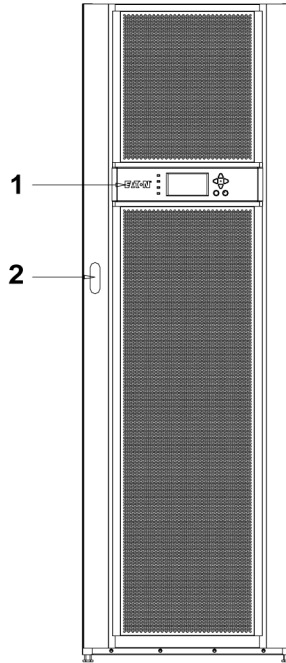

Figure 33. UPS controls and indicators

1 Control panel

2 Door latch

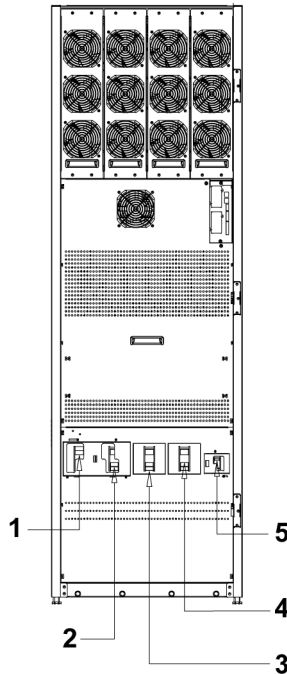

Figure 34. UPS switches (100-120 kVA units)

- |   |  |   |                           |
|---|--|---|---------------------------|
| 1 | Output switch (optional)                   | 4 | Input switch (optional)   |
| 2 | Maintenance bypass switch (MBS) (optional) | 5 | Neutral switch (optional) |
| 3 | Bypass switch (optional)                   |   |                           |

## 7.2 Using the control panel

The following sections describe the UPS control panel, including the controls and indicators, and how to monitor the UPS operation. The control panel is located in the front door of the UPS.

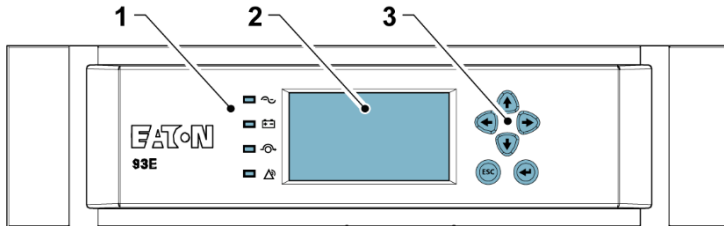

Figure 35. UPS control panel

- 1 Status indicators
- 2 LCD display
- 3 Navigation push buttons

The control panel consists of:

- A liquid crystal display (LCD)
- Menu navigation push buttons switches
- A vertical column of status indicators. See Section 7.2.1.



The following sections describe how to use the UPS control panel to monitor the UPS.



When the unit powers up, the screen displays the Eaton logo. To advance to the main menu and the Mimic screen, press any control panel push button once.

### 7.2.1 Status indicators

The four symbols below the display are status indicators. They are colored light emitting diode (LED) lamps, and they work in conjunction with the alarm horn to let you know the operating status of the UPS.

Table 19: Status indicators

Indicator	Status	Description
Green symbol for normal operation 	On	The UPS is in the Double conversion (Normal), HE, or stored energy mode. The UPS is operating normally and supplying power to the critical load.
	Off 	The UPS is turned off.  <b>Note:</b> The UPS could still be in the bypass mode when the LED is off.
Yellow symbol for battery mode 	On	The UPS is in the stored energy mode. Because the stored energy mode is a normal condition of the UPS, the green indicator for normal operation also remains illuminated.

Indicator	Status	Description
Yellow symbol for bypass mode 	On	The UPS is in the bypass mode. The critical load is supported by the bypass source. The green indicator for normal operation is not illuminated when the system is in the bypass mode.
		<b>Note:</b> In the HE mode, the bypass LED indicator is not illuminated.
Red symbol for active alarm 	On	The UPS has an active alarm and requires immediate attention. The screen shows the highest priority active alarms. All alarms are accompanied by an audible horn. To silence the horn, press any control panel button once. The alarm indicator may be illuminated along with other indicators.
	Flash- ing	There is a new UPS alarm condition. The indicator flashes until acknowledged by pressing any control panel push button once.

### 7.2.2 System events

When the UPS system is running in normal operation modes, it continually monitors itself and the incoming utility power. In the stored energy mode, the UPS may issue alarms to let you know exactly what event caused the change from the normal operation modes. System events on the UPS can be indicated by horns, lights, messages, or all three.

Select **Events** symbol from the menu bar on the main menu screen to display the active events screen. This screen shows any currently active alarms, notices, or commands. For more information on using the events screen, see Section [7.2.6](#).

- **System event horn**  
The system event horn beeps to alert the user that an event requiring attention is taking place. To silence the horn beeps, press any push button.
- **System event indicators**  
The status indicators on the UPS control panel and the event horn let you know when the UPS system is operating in any mode other than the double conversion mode. Only the green indicator for normal operation is visible during normal UPS system operation. The other indicators illuminate to indicate alarms or events. When an alarm occurs, first check these indicators to see what type of event has taken place. For descriptions of the status indicators, see Section [7.2.1](#).
- **System event messages**  
When a system event occurs, a message appears in the status bar of the display. This message is also written to the Events log and may be added to the History log. The messages are divided into four categories: alarms, notices, status, and commands.

### 7.2.3 Using the LCD and push buttons

The LCD on the control panel provides an operator interface with the UPS system. Figure 36 below identifies the display areas discussed in the following sections.

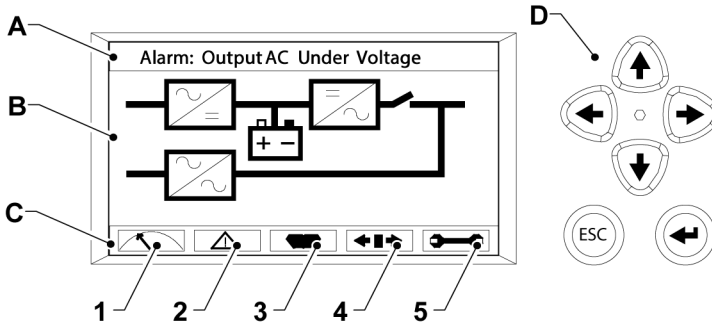

Figure 36. Parts of the LCD

<b>A</b>	<i>UPS status area</i>	<b>1</b>	<i>Meter</i>
<b>B</b>	<i>Information area</i>	<b>2</b>	<i>Events</i>
<b>C</b>	<i>Menu bar</i>	<b>3</b>	<i>History</i>
<b>D</b>	<i>Navigation push buttons</i>	<b>4</b>	<i>Controls</i>
		<b>5</b>	<i>Setup</i>

- **UPS status**  
The UPS status area automatically scrolls between the Eaton model number, current date and time, active alarms, UPS status, load percent, and battery runtime for the UPS. The top line of display blinks while scrolling when the system needs attention. Some notices and alarms may be accompanied by an audible horn. To silence the horn, press any control panel push button once. Shown is a typical alarm message. For more information about alarms and notices, see Section 7.2.2.
- **Information area**  
The information area contains information about UPS status and operations.
- **Menu bar**  
The menu bar shows the symbols of the available screens. To select a screen, highlight the screen symbol using the navigation push buttons and then press the **Enter** push button.
- **Navigation push buttons**  
The navigation push buttons function depending on the screen displayed. Use the **Up**, **Down**, **Left** and **Right** push buttons to scroll through available screens and the **Esc** and **Enter** push buttons to select menu screens and functions.



You can use the LCD and the push buttons to:



- Look at a log of UPS events (alarms, notices, and commands), see Section [7.2.6](#)
- Monitor UPS operation, see Section [7.2.6](#)
- Set UPS parameters, see Section [7.2.6](#)
- Control UPS operation, see Sections [7.2.6](#) and [7.2.7](#).

After approximately 10 minutes, the display screen darkens. To restore the screen, press any push button once.

## 7.2.4 Using the menu

The UPS menu bar allows you to display data in the information area to help you monitor and control the UPS operation.

*Table 20: Display function menu map*

Menu option	Description
<b>METERS</b>	Displays performance meters for the system or critical load.
<b>EVENTS</b>	Displays the list of active system events.
<b>HISTORY</b>	Displays a historical log of system events.
<b>CONTROLS</b>	Displays the System Control screen.
<b>SETUP</b>	Allows you to set the date and time for the time stamp, the display language, the unit name, and meter subscripts. Also allows you to change the password, and view the firmware version numbers.
<b>ESC (push button)</b>	Returns to the main menu and the Mimic screen from the Meters, Events, History, Controls, or Setup screens. Returns to the main System Setup Level screen from a setup submenu.
	The enter arrow acknowledges or executes a command, or saves a setting.
	The up and down arrows scroll through the screens and lists or highlight settings.
	The left and right arrows select or adjust settings displayed on the screen.

## 7.2.5 Mimic screen

To select the Mimic screen from the Meters, Events, History, Controls, or Setup screens, press the **ESC** push button on the current menu bar.

The Mimic screen shows the internal components of the UPS cabinet and a real-time graphical representation of the operating status of the system.

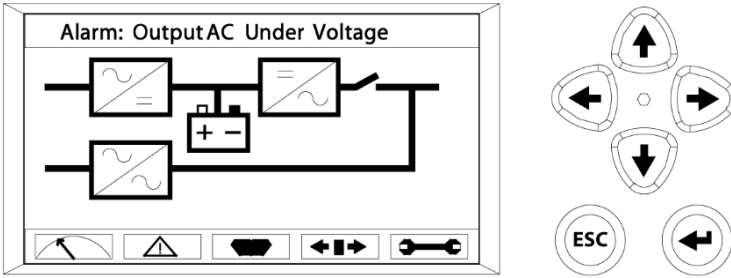

Figure 37. Main menu and the Mimic screen

### 7.2.6 Display menu operation























Table 21 describes the menu functions and how to use them.



































**Note:** The UPS is not a measuring device. All displayed measurements on the meter screen are only approximate values.

Table 21: Display menu operation

Function	Sub-function	Operation
Meters – UPS		The Meters screens show the UPS meter readings for the unit. The default voltage displayed on these screens is phase-to-neutral. These can be changed to display the voltage phase-to-phase (A-B, B-C, C-A). Use the ← or → push buttons to select the <b>METERS</b> symbol on the main menu bar to display the Meter screens. To scroll through the Meter screens, press the ↑ or ↓ push button. The current UPS readings are displayed in the information area of the screen.
	Output – UPS	The Output screen shows the output voltage (phase to neutral), output current (each phase), and frequency being supplied by the UPS, as well as the kVA, kW, and power factor measurements.
	Input – UPS	The Input screen shows the input voltage (phase to neutral), input current (each phase), and frequency of the incoming utility source, as well as the kVA, kW, and power factor measurements.
	Bypass	The Bypass screen shows the bypass input voltage (phase to neutral), input current (each phase), and frequency of the incoming utility source, as well as the kVA, kW, and power factor measurements.
	Battery – UPS	The Battery screen displays the battery voltage (Vdc), the battery current (Idc) and battery time remaining (BTR).

Function	Sub-function	Operation
Events		Use the  or  push buttons to select the <b>EVENTS</b> symbol on the main menu bar to display the Events screens. A listing of all the system events that are currently active is displayed. The most recent event is listed first. As the events clear, they are removed from the events listing. To scroll through the events, press the  or  push button.
History		Use the  or  push buttons to select the <b>HISTORY</b> symbol on the main menu bar to display the History screen. The history log lists up to 1024 events in chronological order, with the most recent event listed last (once 1024 is reached, the earliest event is overwritten). The end of the log (the most recent events) is displayed first. Scroll upward to view older event listings. To scroll through the events, press the  or  push button.
Setup – User	Function Selection	This screen can be used to display user information and show the installed firmware versions. Use the  or  push buttons to select the <b>SETUP</b> symbol on the main menu bar to display the Setup screen. Use the  or  push button to highlight the desired function, then press the  push button to display the function screen. See Figure 38 for a typical screen display.
	User Info	The User Info screen provides the model, CTO and serial numbers of the UPS, the output voltage, frequency, and kVA rating, the input voltage rating, and the battery run time rating. Use the  or  push buttons to select <b>USER</b> on the Setup menu bar. Use the  or  push button to select <b>Info</b> , then press the  push button to display the function screen. To return to the System Setup screen, press the <b>ESC</b> push button.
	About	The About screen provides the installed firmware version numbers on the UPS. Use the  or  push buttons to select <b>USER</b> on the Setup menu bar. Use the  or  push button to select <b>About</b> . To return to the System Setup screen, press the <b>ESC</b> push button.

Function	Sub-function	Operation
Setup – Config (System Level 1 Set-up)	Password	To enter a password if required, use the ← or → push button to select the password character position. Use the ↑ or ↓ push button to change the password character. Once the password is entered, select <b>DONE</b> and then press the ← push button. The System Setup Level 1 menu screen is displayed. The default System Setup Level 1 password is 0101.
	Function Selection	This screen can be used to set the date and time, change the display language, enter a unit name, change the meter style, perform a lamp test, clear the history log, and enter a password to access level 1 functions. Use the ← or → push buttons to select the <b>SETUP</b> symbol in the main menu bar to display the Setup screen. Use the ← or → push button to select <b>CONFIG</b> on the Setup menu bar. Enter a password, if required.
	Clock	The Clock screen allows the selection of either month/day/year or day/month/year formats and daylight savings time for display on the screen and for logging events in the Event and History Logs. Use the ↑ or ↓ push button to select <b>CLOCK</b> to display the Clock screen. Use the ↑ or ↓ push button to highlight the desired format, then press the ← push button to display the Set Date and Time screen. To return to the System Setup screen, press the <b>ESC</b> push button.
	Set Date and Time MM/DD/YYYY	The Set Date and Time MM/DD/YYYY screen allows the internal date and time of the UPS to be set in the month/day/year format. The date and time information is used for display on the screen and for logging events in the Event and History Logs. Use the ← or → push button to highlight the setting to be changed. Use the ↑ or ↓ push button to make the change. When finished making changes, use the ← or → push button to highlight <b>SAVE</b> and the ↑ or ↓ push button to select <b>YES</b> . To complete the save function and return to the System Setup screen, press the ← push button.
	Language	The Language Setup screen allows you to select the display menu language. Use the ↑ or ↓ push button to highlight <b>Language</b> , then press the ← push button to display the Language screen. Use the ↑ or ↓ push button to highlight the desired language, then press the ← push button. To return to the System Setup screen, press the <b>ESC</b> push button.

Function	Sub-function	Operation
Setup – Config (System Level 1 Set-up)	Unit Name	<p>The Unit Name Setup screen allows you to enter a unit name.</p> <p>Use the  or  push button to highlight <b>Unit Name</b>, then press the  push button to display the Unit Name screen.</p> <p>Use the  or  push button to highlight the character to be changed. Use the  or  push button to make the change. When finished making changes, use the  or  push button to highlight <b>SAVE</b> and the  or  push button to select <b>YES</b>. To complete the save function and return to the System Setup screen, press the  push button. To return to the System Setup screen, press the <b>ESC</b> push button.</p>
	Meters	<p>The Meters Setup screen allows you to select the Meters Screen display style. Use the  or  push button to highlight <b>Meters</b>, then press the  push button to display the Meters screen. Use the  or  push button to highlight the desired style, then press the  push button. To return to the System Setup screen, press the <b>ESC</b> push button.</p>
	Lamp Test	<p>The Lamp Test screen allows you to test the control panel status lamps. Use the  or  push button to highlight <b>Lamp Test</b>, then press the  push button to illuminate the status lamps. To return to the System Setup screen, press the <b>ESC</b> push button.</p>
	Clear Log	<p>The Clear Log screen allows you to clear the history log. Use the  or  push button to highlight <b>Clear Log</b>, then press the  push button to clear the log. To return to the System Setup screen, press the <b>ESC</b> push button.</p>
	P/W	<p>The P/W screen is used to change the System Setup Level 1 password. Use the  or  push button to highlight <b>P/W</b>, then press the  push button to display the P/W screen. Use the  or  push button to select the password character position. Use the  or  push button to change the password character. Once the password is entered, select <b>CHANGE</b> and then press the  push button.</p>
Controls		See Section <a href="#">7.2.7</a> for details.

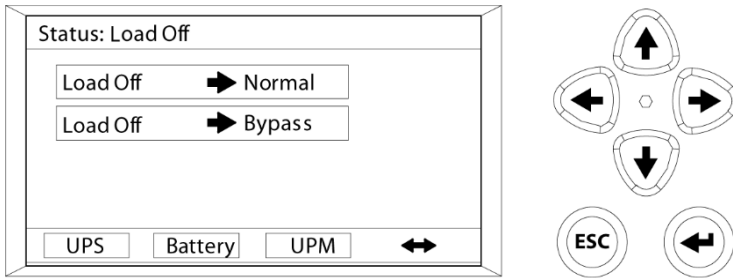





Figure 38. Typical initial setup screen

## 7.2.7 System controls

To display the Controls screen, select the **CONTROLS** symbol in the main menu bar and press the  push button. Use the Controls screen to control the normal operation, transfer to bypass, load off, and charger control commands. In addition, the screen displays the current status of the UPS. Figure 39 shows the System Control screen.

Use the  or  push button to highlight the desired command screen, then press the  push button to display the command menu screen.



Use the  or  push button to highlight the desired command.

Table 22 describes the control functions and provides instructions on how to access and use the command menu screens.

For detailed information about using the System Controls, see Section 7.3.

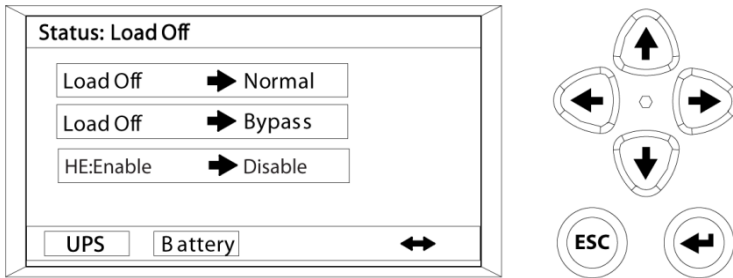

Figure 39. Typical system control screen

Table 22: Command menu operation

Function	Sub-function	Operation
UPS Control Commands		Use the <b>↑</b> or <b>↓</b> push button to highlight the desired command function, then press the <b>←</b> push button to execute the command or proceed to further command screens.
	Normal Mode	Starts the UPS in the double conversion (normal) mode, or transfers the UPS from the bypass mode to the double conversion (normal) mode.
	Bypass Mode	Starts the UPS in the bypass mode, or transfers the UPS to the bypass mode from double conversion, stored energy or HE modes.
	High-Efficiency (HE) Mode	Transfers the UPS from the double conversion (normal) mode to the HE mode. Transfers the UPS from the HE mode to the double conversion (normal) mode. Transfer to the HE mode will not happen instantly. Charging current needs to be at an appropriate level so that the HE mode can be supported.
	Load off	When the unit is in the double conversion mode, the load off command turns off the inverter, but the rectifier and charger will stay on. In the bypass mode, the load off command turns off the SCRs and stops the load supply.
Battery Control Commands		Use the <b>↑</b> or <b>↓</b> push button to highlight the desired command function, then press the <b>←</b> push button to execute the command.
	Charger	Turns the battery charger on.
	Resting	Turns the battery charger off.
	Testing	When the charger is turned off, the testing command is available for performing battery capacity testing.

## 7.3 Operating a single UPS



### Note:

Switch operation nomenclature: Open = O = Off, Closed = I = On.

Refer to the External Battery Cabinet Installation Manual for EBC battery breaker location.

### 7.3.1 Starting the UPS system in the double conversion (default) mode

To start the UPS system:

1. Open the UPS front door by lifting the latch from the bottom and turning it counterclockwise. Swing the door open.
2. If the UPS contains input and output switches, verify that the input and output switches are open.



**Note:** This is only necessary for the 100/120 kVA units with the optional MBS and input switches installed.

3. If the UPS contains a bypass input switch (BIS) (100-120 kVA), verify that the BIS is open.
4. If the UPS contains an internal maintenance bypass switch (MBS) (100-120 kVA), verify that the MBS and BIS are open and the neutral switch is closed.
5. Close the UPS input feeder circuit breaker.
6. If the UPS is fed from two input sources, close the UPS bypass input feeder circuit breaker.
7. If the UPS contains an input switch, close the input switch.
8. If the UPS contains a bypass input switch (BIS), close the BIS.
9. If the UPS contains an output switch, close the output switch.
10. Close the door and secure the latch.
11. Close the external battery breakers.  
Observe the UPS control panel display becoming active, indicating logic power.
12. Verify that no alarms are active. Notices are not to be misinterpreted as alarms.
13. Select the CONTROLS symbol on the main menu bar. The System Control screen is displayed.
14. If not already selected, select UPS on the System Control screen.
15. On the UPS System Control screen, select the LOAD OFF -> NORMAL command, then press the **Enter** push button.
16. If requested, enter the Level 1 password. The default password is 1111.



At first, the UPS turns to the bypass mode. Simultaneously, the DC-link is charged. When the appropriate DC-link voltage level has been reached, the rectifier turns on. A few seconds from this, the inverter turns on.

It takes approximately one minute for the UPS to achieve the double conversion (normal) mode.

Once the inverter reaches full voltage, the UPS output contactor closes and the static switch turns off. Power is now supplied to the critical load in the double conversion mode.

The normal status indicator is illuminated.

17. If there is an external output switch, close the external output switch.

### 7.3.2 Starting the UPS in the bypass mode

If the inverter output of the UPS is not available and the critical load needs to be energized, perform the following procedure:

#### CAUTION



In the bypass mode, the critical load is not protected from commercial power interruptions and abnormalities.

1. Open the UPS front door by lifting the latch from the bottom and turning it counterclockwise. Swing the door open.
2. If the UPS contains input and output switches, verify that the input and output switches are open.



**Note:** This is only necessary for the 100/120 kVA units with the optional MBS and input switches installed.

3. If the UPS contains a bypass input switch (BIS) (100-120 kVA), verify that the BIS is open.
4. If the UPS contains an internal maintenance bypass switch (MBS) (100-120 kVA), verify that the MBS and BIS are open and the neutral switch is closed.
5. Close the UPS input feeder circuit breaker.
6. If the UPS is fed from two input sources, close the UPS bypass input feeder circuit breaker.
7. If the UPS contains an input switch, close the input switch.
8. If the UPS contains a bypass input switch (BIS), close the BIS.
9. If the UPS contains an output switch, close the output switch.
10. Close the door and secure the latch.
11. Close the external battery breakers.  
Observe the UPS control panel display becoming active, indicating logic power.
12. Verify that no alarms are active. Notices are not to be misinterpreted as alarms.

13. Select the **CONTROLS** symbol on the main menu bar. The System Control screen is displayed.
14. If not already selected, select **UPS** on the System Control screen.
15. On the UPS System Control screen, select the **LOAD OFF -> BYPASS** command, then press the **Enter** push button.
16. If there is an external output switch, close the external output switch.

### 7.3.3 Transferring from the double conversion mode to the bypass mode

#### CAUTION



In the bypass mode, the critical load is not protected from mains power interruptions and abnormalities.

To transfer the critical load to the bypass mode, perform the following procedure:

1. In the home screen, press **Controls**.  
The System Control screen appears.
2. If not already selected, select **UPS** on the System Control screen.
3. In the System Control screen, select the **NORMAL -> BYPASS** command.  
Confirm your selection.  
The UPS system transfers to the bypass mode. The **BYPASS** status indicator is illuminated. The inverter contactor opens, but the rectifier and inverter stay on.

#### WARNING



Power is present inside the UPS cabinet.

### 7.3.4 Transferring from the bypass mode to the double conversion mode

To transfer the critical load to the double conversion mode, perform the following procedure:

1. In the home screen, press the **Controls** symbol.  
The System Control screen appears.
2. If not already selected, select **UPS** on the System Control screen.
3. In the System Control screen, select the **BYPASS -> NORMAL** command.  
Confirm your selection.  
The UPS system transfers to the double conversion mode. If the power module is not available, the system remains on bypass and an alarm sounds.  
The green normal status indicator is illuminated.

### 7.3.5 Transferring from the double conversion mode to the HE mode

To transfer the load to the HE mode, perform the following procedure:

1. In the home screen, press **Controls**.  
The System Control screen appears.
2. If not already selected, select UPS on the System Control screen.
3. In the System Control screen, select the HE: DISABLE -> ENABLE command. Confirm your selection.  
The UPS transfers to the HE mode if no abnormal power conditions are detected. If abnormal power conditions are detected, the UPS will wait and transfer to the HE mode when conditions are cleared. Also the charging current causes delay in the transfer to the HE mode.  
The green normal status indicator is illuminated.

### 7.3.6 Transferring from the HE mode to the double conversion mode

To transfer the load to the double conversion (normal) mode, perform the following procedure:

1. In the home screen, press **Controls**.  
The System Control screen appears.
2. If not already selected, select UPS on the System Control screen.
3. In the System Control screen, select the HE: ENABLE -> DISABLE command. Confirm your selection.  
The UPS transfers to the double conversion (normal) mode.  
The green normal status indicator is illuminated.

### 7.3.7 Transferring from normal operation modes to internal maintenance bypass (optional on 100-120 kVA)

To transfer the load to maintenance bypass, perform the following procedure:

1. Loosen the screws that fix the cover over the maintenance bypass switch. Slide the cover to the right.  
This action will signal the UPS to transfer to the bypass mode. Refer to Figure 40 for the switch arrangement.
2. Verify that the LCD display and status indication LED indicate that the UPS is in the bypass mode.
3. Close the maintenance bypass switch.
4. Open the UPS output switch. The UPS is now bypassed, with the load powered directly by utility power.
5. Open the UPS input and bypass input switches (BIS).
6. Loosen the screws that fix the cover over the neutral switch and push the cover to the left, then open the neutral switch.



**Note:** The maintenance bypass operation must be performed by an Eaton authorized Customer Service Engineer.

### WARNING

Power is present inside the UPS cabinet.

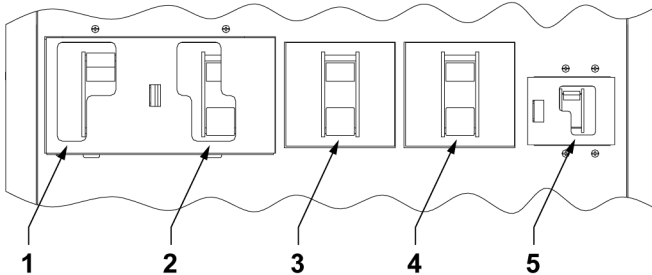

Figure 40. 100-120 kVA Optional internal maintenance bypass switch arrangement

- |   |                           |   |                |
|---|---------------------------|---|----------------|
| 1 | Output switch             | 4 | Input switch   |
| 2 | Maintenance bypass switch | 5 | Neutral switch |
| 3 | Bypass input switch       |   |                |

## 7.3.8 Transferring from internal maintenance bypass to normal mode (optional on 100-120 kVA)

To transfer the load to the normal mode, perform the following procedure:

1. Close the neutral switch, slide the cover plate right, and tighten the screws.
2. Close the input and bypass input switches.
3. Restart the UPS in bypass mode by performing the procedure in Section [7.3.2](#).
4. Verify that the UPS is in the bypass mode.
5. Close the output switch.
6. Open the maintenance bypass switch (MBS), slide the cover plate left, and tighten the screws.
7. Transfer the load to the double conversion (normal) mode. For instructions, see Section [7.3.1](#) or [7.3.4](#).

## 7.3.9 Shutting down the UPS system and critical load

To perform maintenance or service on the critical load, shut down the power to the load by performing the following procedure:

1. Turn off all the equipment that is powered by the UPS system.
2. Perform the LOAD OFF procedure in Section 7.3.12.  
The output contactor opens and the inverter is turned off.
3. Perform the battery charger off procedure in Section 7.3.10.  
The input and battery contactors open.

**DANGER**

Power is still present inside each UPS cabinet until the upstream feeder circuit breaker is opened, and in case of a parallel system, the output is isolated or parallel units are shut down as well.

4. Open the UPS input switch.
5. If the UPS contains a bypass input switch (BIS), open the BIS.
6. If the UPS contains a maintenance bypass switch (MBS), verify that the MBS is open.
7. Open the UPS input and bypass feeder circuit breakers.
8. Open all external battery breakers.

### 7.3.10 Charger control

To turn the battery charger on:

1. Select the **CONTROLS** symbol in the main menu bar.  
The System Control screen is displayed.
2. Select **Battery** in the System Control screen.
3. In the Battery System Control screen, select the **RESTING → CHARGING** command and press the  push button.

To turn the battery charger off:

1. Select the **CONTROLS** symbol in the main menu bar.  
The System Control screen is displayed.
2. Select **Battery** in the System Control screen.
3. In the Battery System Control screen, select the **CHARGING → RESTING** command and press the  push button.

### 7.3.11 Battery test



**Note:** This UPS has a user initiated battery test that is intended to determine if the batteries are able to support the load.

The battery test can only be initiated when the battery is fully charged. This normally occurs within 72 hours of the start of a charging cycle. The command is not shown if the test cannot be run.

To start the battery test:

1. Select the **CONTROLS** symbol in the main menu bar.  
The System Control screen is displayed.
2. Select **Battery** in the System Control screen.
3. In the Battery System Control screen, select the **RESTING → TESTING** command and press the  push button.

### 7.3.12 Using the UPS LOAD OFF command

A UPS Load Off is initiated by selecting the **Load Off** command in the UPS Control screen. The UPS LOAD OFF controls the UPSs output by powering down the UPS and de-energizing the critical load.

The UPSs (including bypass) remains off until restarted.

To use the LOAD OFF command:

1. Select the **CONTROLS** symbol in the main menu bar on the UPS to be shut down.  
The System Control screen is displayed.
2. Select **UPS** in the System Control screen.
3. In the UPS System Control screen, select the **NORMAL → LOAD OFF** or **BYPASS → LOAD OFF** command depending on the UPS mode, then press the  push button.  
The Verify Action screen is displayed, providing you with a choice to proceed or abort the shutdown.

#### CAUTION



All power to the critical load is lost when the LOAD OFF command is confirmed in the following step. You should use this feature only when you want to de-energize the critical load.

4. Select **Yes** or **No** and press the  push button.  
Selecting **Yes** immediately shuts down the UPS and de-energizes the critical load. Selecting **No** aborts the shutdown.
5. To restart the UPS after pressing the **LOAD OFF** push button, follow the procedure in Sections [7.3.1](#) or [7.3.2](#).

#### WARNING



Power is present inside the UPS cabinet after the upstream input feeder circuit breakers are opened because of the installed external battery cabinet.

### 7.3.13 Using the remote emergency power-off switch

A UPS emergency power-off is initiated by the remote EPO push-button switch. In case of an emergency, you can use this switch to control the UPS output. The

remote EPO switch de-energizes the critical load and powers down the UPS immediately without asking for verification. The UPS, including bypass, remains off until it is restarted.

### CAUTION



When the EPO switch is activated, all power to the critical load is lost. Use this feature only when there is an emergency and the critical load must be de-energized immediately.



**Note:** The following instructions are for the EPO switch supplied by Eaton Corporation. If you are using a customer-supplied EPO switch, it may not activate in the same way. For operating instructions, see the documentation provided with the switch.

To use the remote EPO switch:

1. Firmly press the EPO push-button switch.  
The switch latches into the activated state. The input, output, battery, and bypass backfeed contactors open, and the power module is turned off immediately, without asking for verification.

### CAUTION



Do not attempt to restart the system after using the EPO switch until the conditions for safe start-up have been confirmed.

2. To deactivate the remote EPO switch in preparation for restarting the UPS, insert the supplied key and rotate it clockwise until the remote EPO push button releases. To remove the key, rotate the key back to the vertical position.
3. To restart the UPS, follow the procedure in Section [7.3.1](#) or [7.3.2](#).

### WARNING



Hazardous voltages might be present inside the UPS cabinet after the upstream input feeder circuit breakers are opened if the OVR type tripping is not used for opening the external battery breaker.

## 7.4 Multiple UPS parallel operation

This section provides operating instructions for a UPS system containing multiple UPSs.



**Note:** Refer to the External Battery Cabinet Installation Manual for the EBC battery breaker location.

Start and control the system wide function from UPS 1.

## 7.4.1 Starting the parallel UPS in the double conversion mode (default mode)

To start the UPS system:

1. Open the front door by lifting the latch from the bottom and turning it to the right (counterclockwise). Swing the door open.
2. Make sure that all input and bypass input switches are open.



**Note:** This is only necessary for the 100/120 kVA units with the optional MBS and input switches installed.

3. If the UPSs contain a maintenance bypass switch (MBS), make sure that the MBS is open.
4. Close all module output breakers (MOBs).
5. Close the UPS input feeder circuit breakers.
6. If the UPSs are wired for dual input, close all of the UPSs bypass input feeder circuit breakers.
7. Close all input switches.
8. Close the neutral switch in 100/120 kVA units.
9. If the UPSs contain a bypass input switch (BIS), close the BIS.
10. Close the door and secure the latch.
11. Close the external battery breakers.
12. Wait until the UPS control panel display becomes active and indicates logic power.
13. Verify that no alarms are active. Notices are not to be misinterpreted as alarms.
14. Select the **CONTROLS** symbol in the main menu bar.  
The System Control screen is displayed.
15. If not already selected, select **UPS** in the System Control screen.
16. In the UPS System Control screen, select the **LOAD OFF → NORMAL** command and press the  push button.
17. If requested, enter the Level 1 password. The default Level 1 password is 1111.  
After the password is entered, the system goes to the bypass at first and simultaneously charges the DC-link. When the DC-link is at the appropriate level, the rectifier and inverter start up.  
Once all inverters reach full voltage, the UPS output contactor closes and the static switch turns off. Power is now supplied to the critical load in the double conversion (normal) mode. It takes approximately one minute for the UPS to achieve the double conversion (normal) mode.  
The green normal status indicator is illuminated.
18. If the UPS contains an output switch, close the output switch.



## 7.4.2 Starting the parallel UPS in the bypass mode

If the inverter output of the parallel UPS is not available and the critical load needs to be energized:

### CAUTION



In the bypass mode, the critical load is not protected from commercial power interruptions and anomalies.

1. Open the front door by lifting the latch from the bottom and turning it to the right (counterclockwise). Swing the door open.
2. Make sure that all input and bypass input switches are open.



**Note:** This is only necessary for the 100/120 kVA units with the optional MBS and input switches installed.

3. If the UPSs contain a maintenance bypass switch (MBS), verify that the MBS is open.
4. Close all module output breakers (MOBs).
5. Close all UPS input feeder circuit breakers.
6. If the UPSs are wired for dual input, close all of the UPS bypass input feeder circuit breakers.
7. Close all input and bypass input switches.
8. Close the neutral switches in 100/120 kVA units.
9. Close the door and secure the latch.
10. Close the external battery breakers.
11. Wait until the UPS control panel display becomes active and indicates logic power.
12. Verify that no alarms are active. Notices are not to be misinterpreted as alarms.
13. Select the **CONTROLS** symbol in the main menu bar.  
The System Control screen is displayed.
14. If not already selected, select UPS in the System Control screen.
15. In the UPS System Control screen, select the **LOAD OFF → BYPASS** command and press the  push button.  
The critical load is immediately supplied by the bypass source in the bypass mode from all the UPSs.  
The bypass status indicator is illuminated.
16. If the UPS contains an output switch, close the output switch.

### 7.4.3 Transferring from the double conversion mode to the bypass mode



#### CAUTION

In the bypass mode, the critical load is not protected from mains power interruptions and abnormalities.

To transfer the critical load to the bypass mode:

1. On any UPS, press the **Controls** symbol on the main menu bar. The System Control screen appears.
2. If not already selected, select UPS on the System Control screen.
3. On the System Control screen, select the NORMAL -> BYPASS command, then press the **Enter** push button. All the UPSs transfer to the bypass mode. The BYPASS status indicator is illuminated. The power module remains on.



#### WARNING

Power is present inside the UPS cabinet.

### 7.4.4 Transferring from the bypass mode to the double conversion (normal) mode

To transfer the critical load to the double conversion mode:

1. On any UPS, select the CONTROLS symbol on the main menu bar. The System Control screen appears.
2. If not already selected, select UPS on the System Control screen.
3. On the UPS System Control screen, select the BYPASS -> NORMAL command, then press the **Enter** push button.

All of the UPSs transfer to the normal mode. If some of the UPSs are not available, the system remains on bypass and an alarm sounds.

The NORMAL status indicator is illuminated.



#### WARNING

Power is present inside the UPS cabinet.

### 7.4.5 Shutting down a single UPS



**Note:** Make sure that the load level is at a level that can be supported without the UPSs which will be turned off.

To shut down a single UPS:

1. Open the MOB for the UPS being shut down.
2. Select the CONTROLS symbol on the main menu bar.  
The System Control screen is displayed.
3. If not already selected, select UPS on the System Control screen.
4. On the UPS System Control screen, select the NORMAL -> UPS OFF command, then press the **Enter** push button.  
The output contactor opens and the inverter is turned off on the UPS commanded to shut down.



**Note:** Rectifier and logic power remains on.



#### WARNING

Power is present inside the UPS cabinet until the upstream input feeder circuit breaker is opened.

5. Open the UPS input switch and, if installed, the bypass feeder circuit breakers for the UPS being shut down.
6. If EBCs are installed, open all battery breakers.  
The UPS is now completely shut down.

### 7.4.6 Starting a single UPS

To restart a single UPS from a shutdown state:

1. Close the MOB for the UPS being restarted.
2. Close the UPS input, and if installed, bypass feeder circuit breakers for the UPS being restarted.
3. Close the input switch in the 100/120 kVA units.
4. Close the neutral switch in the 100/120 kVA units.
5. If the UPS contains a bypass input switch (BIS), close the BIS.
6. If the UPS contains an output switch, close the output switch.
7. Close the external battery breakers.
8. On the UPS being restarted, observe the UPS control panel display becoming active, indicating logic power.
9. Make sure that there are no active alarms on the display of the UPS being restarted. Notices are not to be misinterpreted as alarms.
10. On the UPS being restarted, select the CONTROLS symbol on the main menu bar.  
The System Control screen is displayed.
11. If not already selected, select UPS on the System Control screen.
12. On the UPS System Control screen, select the UPS OFF -> NORMAL command, then press the **Enter** push button.

- If requested, enter the Level 1 password. The default password is 1111. Once all inverters reach full voltage, the UPS output contactor closes. The unit will not go to the bypass mode, because otherwise the pull chain will turn the whole system to the bypass mode. Power is now supplied to the critical load in the double conversion (normal) mode along with the other UPSs online. It takes approximately one minute for the UPS to achieve the double conversion (normal) mode.  
The green normal status indicator is illuminated.

#### 7.4.7 Shutting down the UPS system and critical load

To perform maintenance or service on the critical load, shut down the power to the load by performing the following procedure:

- Turn off all the equipment that is powered by the UPS system.
- Perform the LOAD OFF procedure, see Section [7.4.8](#).  
The output and bypass backfeed contactors open, and the inverters are turned off.
- Perform the battery charger off procedure, see Section [7.3.10](#).



#### WARNING

Power is still present inside each UPS cabinet until the upstream feeder circuit breaker is opened, and in case of a parallel system, the output is isolated or parallel units are shut down as well.

- Open all of the UPS input switches.
- If the UPSs contain bypass input switches (BIS), open the BISs.
- If the UPSs contain an output switch, open the output switch.
- Open all of the MOBs.
- Open the UPS input and bypass feeder circuit breakers.
- Open all external battery breakers.

#### 7.4.8 Using the UPS LOAD OFF command

A UPS Load Off is initiated when the **Load Off** command is selected in the UPS Control screen. The UPS LOAD OFF controls the UPS output by powering down the UPS and de-energizing the critical load.

The UPS (including bypass) remains off until restarted.

To use the LOAD OFF command:

- Select the **CONTROLS** symbol in the main menu bar on the UPS to be shut down.  
The System Control screen is displayed.
- Select **UPS** in the System Control screen.

- In the UPS System Control screen, select the **NORMAL → LOAD OFF** or **BYPASS → LOAD OFF** command, depending on the UPS mode, and press the  push button.  
The Verify Action screen is displayed, providing you a choice to proceed or abort the shutdown.

**CAUTION**

When the **LOAD OFF** is confirmed in the following step, all power to the critical load is lost. Only use this feature when you want to de-energize the critical load.

- Select **Yes** or **No** and press the  push button. Selecting **Yes** immediately shuts down the UPS and de-energizes the critical load. Selecting **No** aborts the shutdown.
- To restart the UPS after the **LOAD OFF**, follow the procedure in Section [7.4.1](#) or [7.4.2](#).

**WARNING**

Power is present inside the UPS cabinet after the upstream input feeder circuit breakers are opened because of the installed external battery cabinet.

## 8 UPS maintenance

The components inside the UPS cabinet are secured to a sturdy metal frame. All repairable parts and assemblies are located for easy removal with very little disassembly. This design allows authorized service personnel to perform routine maintenance and servicing quickly. Schedule periodic performance checks of your UPS system to keep it running properly. Regular routine checks of the operation and system parameters enable your system to function efficiently for many trouble-free years.

### 8.1 Important safety instructions

Remember that your UPS system is designed to supply power **EVEN WHEN IT IS DISCONNECTED FROM THE UTILITY POWER**. The UPS module interiors are unsafe until the DC power source is disconnected and the electrolytic capacitors are discharged.

After disconnecting the utility power and the DC power, authorized service personnel must wait at least 5 minutes for capacitor bleed-off before attempting internal access to the UPS module.

#### DANGER



**LETHAL VOLTAGE.** Do not operate the UPS system without the cabinet doors or protective panels secured. Do not make any assumptions about the electrical state of any cabinet in the UPS system.

#### WARNING



All service and maintenance work must be performed only by service personnel qualified and authorized by Eaton.

Since each battery string is an energy source in itself, opening the battery circuit breaker does not de-energize the voltage within the battery string.

#### DANGER



Do not attempt to access any internal area of the battery string yourself. Voltages are always present in the battery strings. If you suspect that a battery string needs service, contact your Eaton service representative.

Observe these precautions when working on or around batteries:

- Remove watches, rings, or other metal objects.
- Use tools with insulated handles.
- Wear rubber gloves and boots.
- Do not lay tools or metal parts on top of batteries or battery cabinets.

- Prior to connecting or disconnecting terminal, disconnect the charging source.
- Determine if the battery is inadvertently grounded. If it is, remove the source of the ground. Contact with any part of a grounded battery can result in an electrical shock. The likelihood of such a shock is reduced if such grounds are removed during installation and maintenance.
- When replacing batteries, use the same number of the same type of batteries.
- Dispose of batteries according to your local codes for disposal requirements.
- Do not dispose of batteries in a fire. Batteries may explode when exposed to flame.
- Do not open or mutilate batteries. Released electrolyte is harmful to the skin and eyes. It may be toxic.

## 8.2 Performing preventive maintenance

The battery cabinets require very little preventive maintenance. However, inspect the system when the UPS is serviced or at least once a year to verify that the units are operating normally and that the batteries are in good condition.

### 8.2.1 Daily maintenance

Perform the following steps every day:

1. Check the area surrounding the UPS system. Make sure that the area is not cluttered, allowing free access to the unit.
2. Check that the air intakes (vents on the front doors) and exhaust opening (the back of the UPS cabinet sections) are not blocked.
3. Make sure that the operating environment is within the parameters specified in Section [4.3.1](#) and Chapter [9](#).
4. Check that the UPS is in the double conversion (normal) or HE-mode (green normal status indicator is illuminated). If the red alarm status indicator is illuminated, or the green status indicator for normal operation is not illuminated, contact your service representative.

### 8.2.2 Monthly maintenance

Perform the following steps once a month:

1. Check the system parameters on the control panel (see Section [7.2](#)).
2. Check the UPS air filters (located behind the front door) and wash or replace as necessary. See Figure [41](#) for filter location. Contact an Eaton service representative for replacement filters. To remove the filters:
  - a. Open the UPS front door by lifting the latch from the bottom and turning to the right (counterclockwise) and swing the door open.

- b. Remove the upper and lower foam filters from the frame on the front door.
  - c. Install the washed or new foam filters into the frame on the front door.
  - d. Close the UPS front door and secure the latch.
3. Record the check results and any corrective actions in a service log.

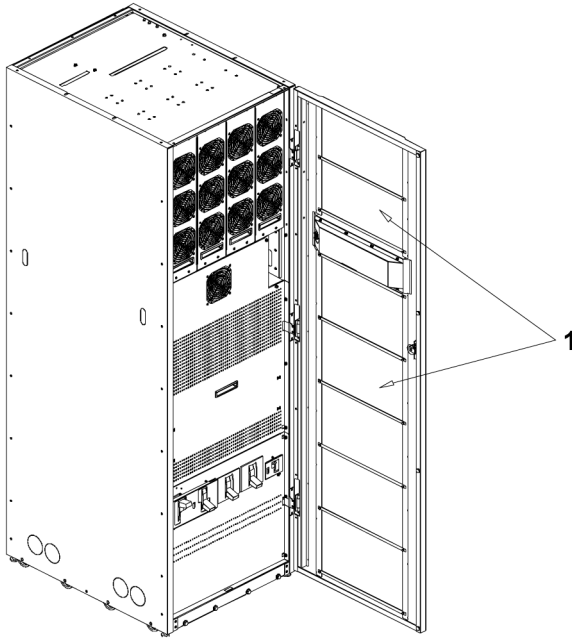

Figure 41. Air filter location

1 Air filter

### 8.2.3 Periodic maintenance

Inspect the UPS periodically to determine if components, wiring, and connections exhibit evidence of overheating. Pay particular attention to bolted connections. Bolted connections must be re-torqued periodically.

### 8.2.4 Annual maintenance

#### WARNING



Only authorized personnel that are familiar with the maintenance and servicing of the UPS system are allowed to perform annual preventive



maintenance. Contact your service representative for more information about service offerings.

### 8.2.5 Battery maintenance

#### WARNING



Only authorized personnel are allowed to perform battery replacement and maintenance. Contact your service representative for battery maintenance.

## 8.3 Recycling the used UPS or batteries

Remove the battery bank before disposing of the UPS or its battery cabinet. Follow the local requirements regarding battery recycling or disposal.

#### WARNING



Only authorized personnel are allowed to remove the batteries due to the risk caused by high energy and voltage.

Do not discard waste electrical or electronic equipment in the trash. For proper disposal, contact your local collecting/recycling/reuse or hazardous waste center and follow the local legislation.

The following symbols indicate a product requiring special handling:

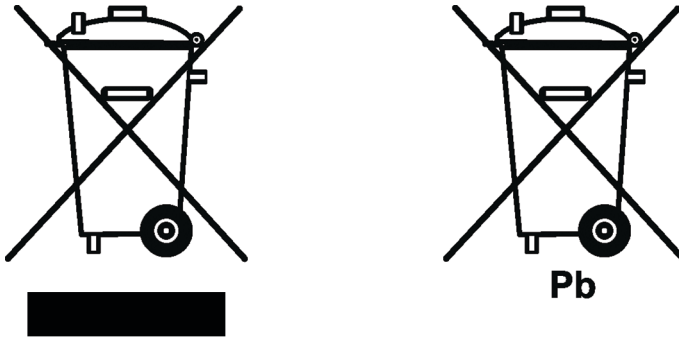

Figure 42. WEEE symbol (left) and battery recycling symbol

When handling waste from electrical and electronic equipment, use proper local collecting centers that meet local legislation.

#### WARNING



HAZARDOUS MATERIALS.

Batteries may contain high voltages and caustic, toxic and flammable substances. If used improperly, batteries can injure or kill people and damage equipment.

Do not discard of unwanted batteries or battery material in the public waste disposal system. Follow all the applicable local regulations regarding the storage, handling and disposal of batteries and battery materials.

## 8.4 Maintenance training

For more information about training and other services, contact your Eaton representative.

## 9 Technical data

For a complete technical specification, contact your Eaton representative. Due to continuous product improvement programs, specifications are subject to change without notice.

### 9.1 Model numbers

The UPS is housed in a free-standing cabinet with safety shields behind the door. The UPS is available in 50 or 60 Hz with various output power ratings.

Table 23: Model numbers

Models	Power rating	Frequency
Eaton 93E G2 100/100	100 kVA	50/60 Hz
Eaton 93E G2 120/120	120 kVA	50/60 Hz
Eaton 93E G2 200/160	160 kVA	50/60 Hz
Eaton 93E G2 200/200	200 kVA	50/60 Hz



### 9.2 UPS system input

Table 24: UPS input

Item	Value
Number of input phases (rectifier & bypass)	3 phases + N
Operating input voltage	380/400/415 Vac
Input voltage range	196/330–276/478V at 100% load 126/201-276/478V at 50% load
Operating input frequency range	50/60 Hz
Input frequency range	40-72 Hz
Operating input current	See Table 11 .
Input current distortion, iTHD	< 3% at load range 80% to 100%
Power factor	> 0.99 at rated load
Back feed protection	Yes, for rectifier and bypass lines
Line surges	6 kV OC, 3 kA SC per ANSI 62.41 and IEC 801 4

Table 25: Battery specification

Item	Value
Battery voltage	432 VDC (36 blocks), 456 VDC (38 blocks) or 480 VDC (40 blocks)

Item	Value
Battery charging capacity	20 A/100 kVA   <b>Note:</b> The input voltage has also impact to the maximum charging current. With the input voltage level of 220 V and 100% load the maximum charging current is lower than 20 A.
Battery type	VRLA (valve regulated lead acid), 12 VDC
Battery quantity	36 (216 cells), 38 (228 cells) or 40 (240 cells) blocks   <b>Note:</b> Do not connect battery strings with different battery quantity and voltage in parallel!
Recharge profile	ABM or float charge
End of discharge voltage	1.85 V/cell for 36 blocks 1.75 V/cell for 38 blocks 1.67 V/cell for 40 blocks

## 9.3 UPS system output

Table 26: UPS output

Item	Value
Number of output phases	3 phases, N
Output voltage regulation	± 1% (10% to 100% load)
Nominal output voltage	380 Vac, 400 Vac and 415 Vac nominal
Output voltage distortion, uTHD	< 2% maximum THD (linear load)
Output current	See Table 11.
Output voltage balance	< 1% for 100% maximum load imbalance (linear load)
Output voltage phase displacement	< 1.5° for 100% maximum load imbalance (linear load)
Rated output frequency	50 or 60 Hz, user configurable
Frequency variation	± 0.1 Hz free running
Synchronous to bypass	± 4 Hz (default setting)
Frequency slew rate	3 Hz per second (default setting)
Load power factor (permitted range)	0.9 p.f. Leading 0.7 p.f. Lagging

Item	Value
Load power factor (rated)	nominal 0.9
Overload capability in double conversion (normal) mode	$\leq 125\%$ for 10 minutes $\leq 150\%$ for 1 minute $\geq 150\%$ for 500 milliseconds
Overload capability in the stored energy mode	102 - 125% for 1 minute 126 - 150% for 30 seconds > 150% for 150 milliseconds
Overload capability in the bypass mode	$< 115\%$ continuous of nominal line current Transient 10 x peak current for 20 milliseconds
Output current limitation, short circuit capability (rms)	100 kVA UPS: 350 A 120 kVA UPS: 440 A 160 kVA UPS: 720 A 200 kVA UPS: 720 A

## 9.4 UPS environmental specifications

Table 27: UPS environmental specifications

Item	Value
Operating temperature	0 to 40 °C without derating. The recommended operating temperature is 20 to 25 °C.
Operating altitude	1000 m without derating, up to 2000 m with derating
Storage temperature	- 25 to 55 °C, excluding batteries (prolonged storage above 40 °C causes rapid battery selfdischarge)
Relative humidity (operating and storage)	5% to 95% maximum noncondensing, recommended range* 20% to 60%
Pollution degree	min PD2
Protective class	Protective class I
IP class	IP20
Earthing systems	TN-s, TN-C, or TN-C-S
Electrical (overvoltage category)	OVCIII
Acoustical noise	$\leq 62$ dB (100-120kVA) and 70 dB (160-200 kVA) at a 1 m distance, at 75% load, per ISO 7779
EMC	IEC 62040-2 ed.3 C3

Item	Value
Maximum rate of temperature change**	1.67 °C/ 5 min

\*Note: For a maximum lifetime for the UPS and batteries, keep the environment in the recommended range.

\*\*Note: The limit is based on ASHRAE 90.1-2013. Rapidly increasing temperature can cause condensation on colder surfaces.

## 9.5 Directives and standards

<b>Safety</b>	IEC 62040-1: Uninterruptible power systems (UPS) - Part 1: General and safety requirements for UPS  IEC 62447-1: Information technology equipment - Safety - Part 1: General requirements (as referred through the IEC 62040-1)
<b>EMC</b>	IEC 62040-2: Uninterruptible power systems (UPS) - Part 2: Electromagnetic compatibility (EMC) requirements / Ed. 3  <ul style="list-style-type: none"> <li>• Emissions: category C3</li> <li>• Immunity: category C3</li> </ul>
<b>Environmental</b>	IEC62040-4: Uninterruptible Power Systems (UPS) - Part 4: Environmental Aspects - Requirements and Reporting  IEC 62430: Environmentally conscious design for electrical and electronic products
<b>RoHS</b>	2011/65/EU on the restriction of the use of certain hazardous substances in electrical and electronic equipment
<b>WEEE</b>	2012/19/EU on waste electrical and electronic equipment (WEEE)
<b>Batteries</b>	2006/66/EC on batteries and accumulators and waste batteries and accumulators
<b>Packaging</b>	94/62/EC on packaging and packaging waste

## 10 Warranty

### 10.1 General

The product is warranted against defects in materials and workmanship for a period of twelve (12) months from its original date of purchase. The local office or distributor may grant a warranty period different to the above. Please refer to local terms of liability as defined in the supply contract.

The UPS manufacturer is not responsible for:

- Any costs resulting from a failure if the installation, commissioning, repair, alteration, or ambient conditions of the equipment do not fulfill the requirements specified in the documentation delivered with the unit and other relevant documentation.
- Equipment subjected to misuse, negligence or accident.
- Equipment comprised of materials provided or designs stipulated by the purchaser.

The warranty is only valid if the installation inspection and initial startup of the UPS unit is carried out by an authorized Eaton Field Service Engineer or by other qualified service personnel authorized by Eaton. Service and maintenance of the UPS shall also be performed only by an authorized Eaton Field Service Engineer or by other qualified service personnel authorized by Eaton. Otherwise the warranty will be voided.

If the product fails to meet its published specifications due to a defect in material and workmanship, covered by this warranty, the seller will repair or replace the warranted product. Such repair or replacement will be made by Eaton or by a service provider approved by Eaton. Repair or replacement during the warranty period does not extend the original warranty. Warranty does not cover taxes, which will be due in connection with replacement or repair of the product.

Batteries are warranted against failures in material and workmanship, not against the normal aging and reduction of ampere-hour capacity. The product storage environment has to meet manufacturer's specifications, failure to do this will cause the warranty to be voided.

Under no circumstances shall the manufacturer, its suppliers or subcontractors be liable for special, indirect, incidental or consequential damages, losses or penalties.

The technical data, information and specifications are valid at the time of printing. The UPS manufacturer reserves the right to modifications without prior notice.

## 10.2 Whom to contact in case of Warranty

In case of Warranty, or while unsure if the unit in question is covered by warranty, contact the respective sales organization where the unit was purchased. Have the following information available:

- Purchase order number and purchase order date
  - Installation date
- OR
- Serial number and part number of the unit (information available on the unit's label)



# 11 Appendix A: Recommended secure hardening guidelines

The UPS has been designed with cybersecurity as an important consideration. Number of cybersecurity features are now offered in the product which, if implemented as per the recommendations in this section, would minimize the cybersecurity risk to the UPS. The “secure configuration” or “hardening” guidelines provide information to the users to securely deploy and maintain their product to adequately minimize the cybersecurity risks to their system.

Our company is committed to minimizing the cybersecurity risk in its products and deploys cybersecurity best practices and latest cybersecurity technologies in its products and solutions, making them more secure, reliable and competitive for our customers. Our company also offers Cybersecurity Best Practices whitepapers to its customers that can be referenced at [www.eaton.com/cybersecurity](http://www.eaton.com/cybersecurity).

*Table 28: Secure configuration guidelines*

Category	Description
Asset identification and inventory	<p>Keeping track of all the devices in the system is a prerequisite for effective management of cybersecurity of a system. Make sure that you maintain an inventory of all the components in your system in a manner in which you uniquely identify each component. To facilitate this, the UPS supports the following identifying information: manufacturer, type, serial number, f/w version number, and location.</p> <p>Users can extract device information at locations mentioned below:</p> <ul style="list-style-type: none"> <li>• Product number, serial number and UPS name are listed on the Information screen</li> <li>• Firmware versions can be found on the About screen</li> </ul>

Category	Description
Physical protection	<p data-bbox="479 161 1034 336">Industrial Control Protocols do not offer cryptographic protections at protocol level, at physical ports and at controller mode switches, leaving them exposed to cybersecurity risk. Physical security is an important layer of defense in such cases. The UPS is designed with the consideration that it would be deployed and operated in a physically secure location.</p> <ul data-bbox="479 357 1034 879" style="list-style-type: none"><li data-bbox="479 357 1034 480">• Physical access to the communication lines should be restricted to prevent any attempts of wiretapping or sabotage. It is a best practice to use metal conduits for the communication lines running from one cabinet to another cabinet.</li><li data-bbox="479 488 1034 611">• An attacker with unauthorized physical access to the device could cause serious disruption of the device functionality. A combination of physical access controls to the location should be used, such as locks, card readers, and/or guards.</li><li data-bbox="479 619 1034 692">• The UPS supports the following physical access ports: RS232, USB and slots for communication cards. Access to them must be restricted.</li><li data-bbox="479 700 1034 802">• Do not connect an unauthorized USB device, CD/DVD or SD card for any operation (for example, firmware upgrade, configuration change and boot application change).</li><li data-bbox="479 810 1034 879">• Before connecting any portable device through USB, CD/DVD or SD card slot, scan the device for malwares and viruses.</li></ul>

Category	Description
<p>Authorization and access control</p>	<p>It is extremely important to securely configure the logical access mechanisms provided in the UPS to safeguard the device from unauthorized access. Our company recommends that the available access control mechanisms be used properly to ensure that access to the system is restricted to legitimate users only. And, such users are restricted to only the privilege levels necessary to complete their job roles/functions.</p> <ul style="list-style-type: none"> <li>• Ensure that default credentials are changed upon first login. The UPS should not be commissioned for production with default credentials. It is a serious cybersecurity flaw as the default credentials are published in the manuals.</li> <li>• No password sharing - Make sure that each user gets their own password for that desired functionality instead of sharing the passwords. Security monitoring features of the UPS are created with the view of each user having their own unique password. Security controls will be weakened as soon as the users start sharing the password.</li> <li>• Restrict administrative privileges - Threat actors are increasingly focused on gaining control of legitimate credentials, especially those associated with highly privileged accounts. Limit privileges to only those needed for a user's duties.</li> <li>• Perform periodic account maintenance (remove unused accounts).</li> <li>• Change passwords and other system access credentials whenever there is a personnel change.</li> </ul> <p>Access to service screen and configuration screen is access-controlled. Access to UPS features is restricted based on roles:</p> <ol style="list-style-type: none"> <li>1. Configuration screen can be accessed by the User role.</li> <li>2. Service screen can be accessed only by the Service engineer role.</li> </ol> <p>The following are the access levels in the UPS:</p> <ul style="list-style-type: none"> <li>• Level 1: Control password for User</li> <li>• Level 2: Configure password for User</li> <li>• Level 3: Service password for an authorized Eaton Customer Service Engineer or qualified service personnel authorized by Eaton</li> </ul> <p>Users are recommended to change default passwords on first use of the system. The default session timeout is 10 minutes.</p> <p>The UPS does not enforce any account policies. Customers need to enforce their account policies.</p>

Category	Description
Logging and event management	<p>Best practices:</p> <ul style="list-style-type: none"> <li>• Our company recommends that all administrative and maintenance activities are logged.</li> <li>• Ensure that logs are backed up. Retain the backups for a minimum of 3 months or as per the organization's security policy.</li> <li>• Perform log review at a minimum every 15 days.</li> </ul> <p>The UPS supports the following logging mechanisms:</p> <ul style="list-style-type: none"> <li>• The UPS logs all active events, alarms and notices</li> <li>• Configuration changes made are logged (language change, modify UPS name, etc.)</li> </ul>
Secure maintenance	<p>Best practices:</p> <p><b>Apply firmware updates and patches regularly.</b></p> <p>Due to increasing cyber attacks on industrial control systems, our company implements a comprehensive patch and update process for its products. Users are encouraged to maintain a consistent process to promptly monitor for fresh firmware updates, implement patching and updates as and when required or released.</p> <p>Our company will upgrade the UPS firmware from time to time. If any site needs to upgrade firmware, they can contact the service center for upgrade.</p> <p>Our company also has a robust vulnerability response process. In the event of any security vulnerability getting discovered in its products, our company patches the vulnerability and releases an information bulletin through its cybersecurity web site: <a href="http://eaton.com/cybersecurity">http://eaton.com/cybersecurity</a>.</p> <p><b>Conduct regular cybersecurity risk analyses of the organization/system.</b></p> <p>Our company has worked with third-party security firms to perform system audits, both as part of a specific customer's deployment and within our company's own development cycle process. Our company can provide guidance and support to your organization's effort to perform regular cybersecurity audits or assessments.</p> <p><b>Plan for business continuity/cybersecurity disaster recovery.</b></p> <p>It is a cybersecurity best practice for organizations to plan for business continuity. Establish an OT business continuity plan, periodically review and, where possible, exercise the established continuity plans. Make sure offsite backups include:</p> <ul style="list-style-type: none"> <li>• A backup of the most current configurations</li> <li>• Documentation of the most current user list</li> </ul>

## References:

1. Cybersecurity Considerations for Electrical Distribution Systems (WP152002EN):  
[http://www.eaton.com/ecm/groups/public/@pub/@eaton/@corp/documents/content/pct\\_1603172.pdf](http://www.eaton.com/ecm/groups/public/@pub/@eaton/@corp/documents/content/pct_1603172.pdf)
2. Cybersecurity Best Practices Checklist Reminder (WP910003EN):  
[http://www.cooperindustries.com/content/dam/public/powersystems/resources/library/1100\\_EAS/WP910003EN.pdf](http://www.cooperindustries.com/content/dam/public/powersystems/resources/library/1100_EAS/WP910003EN.pdf)
3. NIST SP 800-82 Rev 2, Guide to Industrial Control Systems (ICS) Security, May 2015.  
<https://ics-cert.us-cert.gov/Standards-and-References>
4. National Institute of Technology (NIST) Interagency "Guidelines on Firewalls and Firewall Policy, NIST Special Publication 800-41", October 2009.  
<http://nvlpubs.nist.gov/nistpubs/Legacy/SP/nistspecialpublication800-41r1.pdf>



*Powering Business Worldwide*

Eaton Power Quality Oy  
Koskelontie 13  
FI-02920 Espoo, Finland  
[www.eaton.eu](http://www.eaton.eu)

Copyright © 2019 Eaton Corporation plc. All rights reserved. Unauthorized copying and lending are prohibited.