

UPS Industrial Gateway Card

INDGW-X2 User's Guide

English



06/12/2023

EATON

Powering Business Worldwide

Eaton is a registered trademark of Eaton Corporation or its subsidiaries and affiliates.

Phillips and Pozidriv are a registered trademarks of Phillips Screw Company.

National Electrical Code and NEC are registered trademarks of National Fire Protection Association, Inc.

Microsoft®, Windows®, and Windows Server® are either registered trademarks or trademarks of Microsoft Corporation in the United States and/or other countries.

UNIX® is a registered trademark of The Open Group.

Linux® is the registered trademark of Linus Torvalds in the U.S. and other countries.

VMware is a registered trademark or trademark of VMware, Inc. in the United States and/or other jurisdictions.

Google™ is a trademark of Google Inc.

All other trademarks are properties of their respective companies.

©Copyright 2019 Eaton Corporation. All rights reserved.

No part of this document may be reproduced in any way without the express written approval of Eaton Corporation.

1 Table of Contents

1	TABLE OF CONTENTS	5
2	INSTALLING THE NETWORK MANAGEMENT MODULE	10
2.1	Unpacking the Network module.....	10
2.2	Mounting the Network Module.....	10
2.3	Wiring the RS-485 Modbus RTU terminal	10
2.3.1	Modbus Common/GND (0V pin on terminal block) connection.....	10
2.3.2	Cable shield connection (foiled or braided).....	11
2.3.3	Two-wire networks.....	11
2.3.4	Four-wire networks	11
2.3.5	Configuring the termination.....	12
2.4	Accessing the Network Module	14
2.4.1	Accessing the web interface through Network.....	14
2.4.2	Finding and setting the IP address	14
2.4.3	Accessing the web interface through RNDIS.....	15
2.4.4	Accessing the card through serial terminal emulation.....	18
2.4.5	Modifying the Proxy exception list	20
2.5	Configuring Modbus	22
2.5.1	Configuring the communication parameters	22
2.5.2	Available maps.....	22
2.5.3	Modbus communication monitoring tool.....	23
2.5.4	Example of supported Modbus mapping	23
3	CONTEXTUAL HELP OF THE WEB INTERFACE	28
3.1	Login page.....	28
3.1.1	Logging in for the first time.....	28
3.1.2	Troubleshooting.....	29
3.2	Home.....	29
3.2.1	Menu structure.....	30
3.2.2	Energy flow diagram examples	31
3.2.3	Access rights per profiles	35
3.3	Meters	36
3.3.1	Main utility input	36
3.3.2	Second utility input (if available)	37
3.3.3	Output	37
3.3.4	Battery status	38
3.3.5	Battery health	39
3.3.6	Logs.....	40
3.3.7	Default settings and possible parameters - Meters	40
3.3.8	Access rights per profiles	41
3.3.9	Save and Restore	41
3.4	Controls	41
3.4.1	Entire UPS	41
3.4.2	Outlets - Group 1/ Group 2	42
3.4.3	Scheduled shutdown.....	43
3.5	Protection	45
3.5.1	Agents list.....	45
3.5.2	Agent shutdown sequencing.....	50
3.5.3	Shutdown on power outage.....	54

3.6	Environment	61
3.6.1	Commissioning/Status.....	61
3.6.2	Alarm configuration	65
3.6.3	Information	69
3.7	Settings	70
3.7.1	General	70
3.7.2	Local users	81
3.7.3	Remote users	86
3.7.4	Network & Protocol.....	99
3.7.5	SNMP	110
3.7.6	Industrial protocols	119
3.7.7	Certificate	129
3.8	Maintenance.....	138
3.8.1	Firmware	138
3.8.2	Services.....	141
3.8.3	Resources.....	146
3.8.4	System logs.....	149
3.8.5	System information	150
3.9	Legal information.....	151
3.9.1	Component.....	151
3.9.2	Availability of source code	151
3.9.3	Notice for proprietary elements.....	151
3.9.4	Access rights per profiles	152
3.10	Alarms	152
3.10.1	Alarm sorting	152
3.10.2	Active alarm counter.....	152
3.10.3	Alarm details.....	153
3.10.4	Alarm paging.....	153
3.10.5	Export	153
3.10.6	Clear	153
3.10.7	Alarms list with codes	153
3.10.8	Access rights per profiles	154
3.11	User profile	154
3.11.1	Access to the user profile.....	154
3.11.2	User profile.....	154
3.11.3	Default settings and possible parameters - User profile	156
3.11.4	Access rights per profiles	157
3.11.5	CLI commands	157
3.11.6	Troubleshooting.....	158
3.11.7	Save and Restore	158
3.12	Documentation	159
3.12.1	Access to the embedded documentation	159
3.12.2	Access rights per profiles	160
4	SERVICING THE NETWORK MANAGEMENT MODULE	161
4.1	Configuring/Commissioning/Testing LDAP	161
4.1.1	Commissioning.....	161
4.1.2	Testing LDAP authentication	162
4.1.3	Limitations	162
4.2	Pairing agent to the Network Module	162
4.2.1	Pairing with credentials on the agent	163
4.2.2	Pairing with automatic acceptance (recommended if done in a secure and trusted network).....	163
4.2.3	Pairing with manual acceptance	163
4.3	Powering down/up applications (examples)	164

4.3.1	Powering down IT system in a specific order	164
4.3.2	Powering down non-priority equipment first	167
4.3.3	Restart sequentially the IT equipment on utility recovery	170
4.4	Checking the current firmware version of the Network Module	171
4.5	Accessing to the latest Network Module firmware/driver/script	171
4.6	Upgrading the card firmware (Web interface / shell script)	172
4.6.1	Web interface	172
4.6.2	Shell script	172
4.6.3	Example:	172
4.7	Changing the RTC battery cell	173
4.8	Updating the time of the Network Module precisely and permanently (ntp server)	175
4.9	Synchronizing the time of the Network Module and the UPS	175
4.9.1	Automatic time synchronization	175
4.9.2	Manual time synchronization	175
4.10	Changing the language of the web pages	175
4.11	Resetting username and password	176
4.11.1	As an admin for other users	176
4.11.2	Resetting its own password	176
4.12	Recovering main administrator password	176
4.13	Switching to static IP (Manual) / Changing IP address of the Network Module	178
4.14	Reading device information in a simple way	178
4.14.1	Web page	178
4.15	Subscribing to a set of alarms for email notification	178
4.15.1	Example #1: subscribing only to one alarm (load unprotected)	178
4.15.2	Example #2: subscribing to all Critical alarms and some specific Warnings	179
4.16	Saving/Restoring/Duplicating Network module configuration settings	181
4.16.1	Modifying the JSON configuration settings file	181
4.16.2	Saving/Restoring/Duplicating settings through the CLI	185
4.16.3	Saving/Restoring/Duplicating settings through the Web interface	185
5	SECURING THE NETWORK MANAGEMENT MODULE	186
5.1	Cybersecurity considerations for electrical distribution systems	186
5.1.1	Purpose	186
5.1.2	Introduction	186
5.1.3	Connectivity—why do we need to address cybersecurity for industrial control systems (ICS)?	186
5.1.4	Cybersecurity threat vectors	186
5.1.5	Defense in depth	187
5.1.6	Designing for the threat vectors	188
5.1.7	Policies, procedures, standards, and guidelines	190
5.1.8	Conclusion	192
5.1.9	Terms and definitions	192
5.1.10	Acronyms	192
5.1.11	References	193
5.2	Cybersecurity recommended secure hardening guidelines	194
5.2.1	Introduction	194
5.2.2	Secure configuration guidelines	194
5.2.3	References	200
5.3	Configuring user permissions through profiles	201
5.4	Decommissioning the Network Management module	201
6	SERVICING THE EMP	202
6.1	Installing the EMP	202
6.1.1	Mounting the EMP	202
6.2	Using the EMP for temperature compensated battery charging	204

6.2.1	Addressing the EMP.....	204
6.2.2	Commissioning the EMP.....	204
6.2.3	Enabling temperature compensated battery charging in the UPS.....	204
7	INFORMATION.....	205
7.1	Front panel connectors and LED indicators.....	205
7.2	Specifications/Technical characteristics	206
7.3	Default settings and possible parameters	207
7.3.1	Settings	207
7.3.2	Meters.....	215
7.3.3	Sensors alarm configuration.....	215
7.3.4	User profile.....	216
7.4	Access rights per profiles	217
7.4.1	Home.....	217
7.4.2	Meters.....	217
7.4.3	Controls	217
7.4.4	Protection	217
7.4.5	Environment	218
7.4.6	Settings	218
7.4.7	Maintenance.....	219
7.4.8	Legal information.....	219
7.4.9	Alarms	219
7.4.10	User profile.....	220
7.4.11	Contextual help.....	220
7.4.12	CLI commands	220
7.5	List of event codes	222
7.5.1	System log codes	222
7.5.2	UPS(HID) alarm log codes	227
7.5.3	UPS(XCP) alarm log codes.....	232
7.5.4	EMP alarm log codes.....	239
7.5.5	Network module alarm log codes.....	240
7.6	SNMP traps	241
7.6.1	UPS Mib	241
7.6.2	Sensor Mib	243
7.7	CLI	243
7.7.1	Commands available.....	244
7.7.2	Contextual help.....	244
7.7.3	get release info.....	245
7.7.4	history.....	245
7.7.5	logout.....	246
7.7.6	maintenance	246
7.7.7	modbus_message_display	246
7.7.8	modbus_statistics.....	247
7.7.9	netconf	248
7.7.10	ping and ping6	250
7.7.11	reboot	251
7.7.12	save_configuration restore_configuration.....	251
7.7.13	sanitize.....	252
7.7.14	ssh-keygen	252
7.7.15	time	253
7.7.16	traceroute and traceroute6.....	254
7.7.17	whoami.....	255
7.7.18	email-test.....	255
7.7.19	systeminfo_statistics.....	256

7.7.20	certificates	256
7.8	Legal information	257
7.8.1	Availability of Source Code	257
7.8.2	Notice for Open Source Elements	258
7.8.3	Notice for our proprietary (i.e. non-Open source) elements	258
7.9	Acronyms and abbreviations	259
8	TROUBLESHOOTING.....	262
8.1	Action not allowed in Control/Schedule/Power outage policy	262
8.1.1	Symptom	262
8.1.2	Possible Cause	262
8.1.3	Action	262
8.2	Card wrong timestamp leads to "Full acquisition has failed" error message on Software.....	262
8.2.1	Symptoms:	262
8.2.2	Possible cause:.....	262
8.2.3	Action:	262
8.3	Client server is not restarting	262
8.3.1	Symptom	262
8.3.2	Possible Cause	262
8.3.3	Action	263
8.4	EMP detection fails at discovery stage	263
8.4.1	Symptom #1	263
8.4.2	Symptom #2	263
8.5	How do I log in if I forgot my password?	264
8.5.1	Action	264
8.6	Software is not able to communicate with the Network module.....	264
8.6.1	Symptoms	264
8.6.2	Possible cause.....	264
8.6.3	Setup	264
8.6.4	Action #1	264
8.6.5	Action #2	265
8.7	LDAP configuration/commissioning is not working.....	265
8.8	Password change in My profile is not working.....	265
8.8.1	Symptoms	265
8.8.2	Possible cause.....	265
8.8.3	Action	265
8.9	SNMPv3 password management issue with Save and Restore	265
8.9.1	Affected FW versions	265
8.9.2	Symptom	266
8.9.3	Cause.....	266
8.9.4	Action	266
8.10	The alarm list has been cleared after an upgrade.....	266
8.10.1	Symptom	266
8.10.2	Action	266
8.11	The Network Module fails to boot after upgrading the firmware	266
8.11.1	Possible Cause	266
8.11.2	Action	267
8.12	Web user interface is not up to date after a FW upgrade	267
8.12.1	Symptom	267

2 Installing the Network Management Module

2.1 Unpacking the Network module

The INDGW-X2 will include the following accessories:

- Installation instructions
- USB AM to Micro USB/M/5P 5ft Cable
- RS-485 wiring terminal



Packing materials must be disposed of in compliance with all local regulations concerning waste. Recycling symbols are printed on the packing materials to facilitate sorting.

2.2 Mounting the Network Module



It is not necessary to power down the Device before installing the Network Module. Required tools: No. 2 Phillips screwdriver.

The Network Module is hot-swappable. Inserting and/or extracting the Network Module from the communication slot of the product has no effect on the output.

Remove the two screws securing the option slot cover plate and store the plate for possible future use.

- Install the Network Module along the alignment channels in the option slot.
- Secure the Network Module using the two screws.

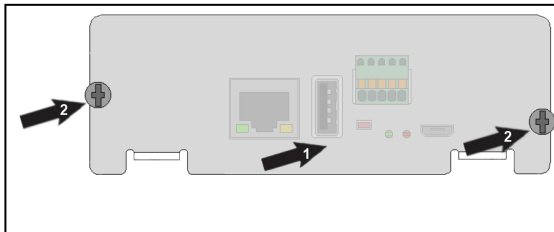

If the product is powered up, you can verify that the Network Module is seated properly and communicating with the product by checking that the Status ON LED flashes green after 2 minutes.

2.3 Wiring the RS-485 Modbus RTU terminal

The Modbus Network Module provides an easy path for integrating an Eaton UPS into an RS-485 Modbus network and also provides isolation of the communication between the UPS and the RS-485 Modbus network.

Use the terminal strip on the Modbus Network Module to wire into a two-wire network.



If the Modbus Network Module is the last device installed in the network chain or the length of the network cable is excessive, termination needs to be enabled.

For details on termination, see the [Installing the Network Management Module>>>Wiring the RS-485 Modbus RTU terminal>>>Configuring the termination](#) section.

2.3.1 Modbus Common/GND (0V pin on terminal block) connection

The Network Module is an isolated device, if all the other devices on the network are isolated, common/GND (0V pin on terminal block) should be connected between devices to limit common mode voltage.

Common/GND (0V pin on terminal block) should not be connected to any other devices that is not isolated to avoid ground loops.

2.3.2 Cable shield connection (foiled or braided)

The cable shield should be continuous on the entire length of the bus and should be connected to ground (earth) at only one point to limit the flow of ground-loop currents in the shield caused by ground potential differences.

2.3.3 Two-wire networks

- Interconnect R- with T- and R+ with T+ on the Modbus Network Module terminal strip.
- Connect the RS-485 network signal + to the R+ or T+ on the Modbus Network Module terminal strip.
- Connect the RS-485 network signal - to the R- or T- on the Modbus Network Module terminal strip.

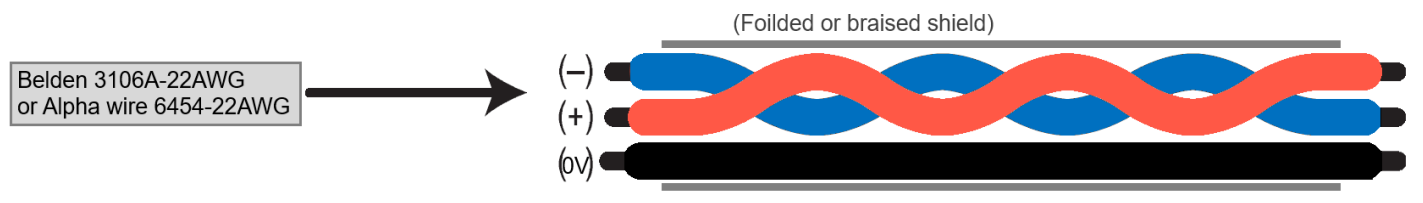
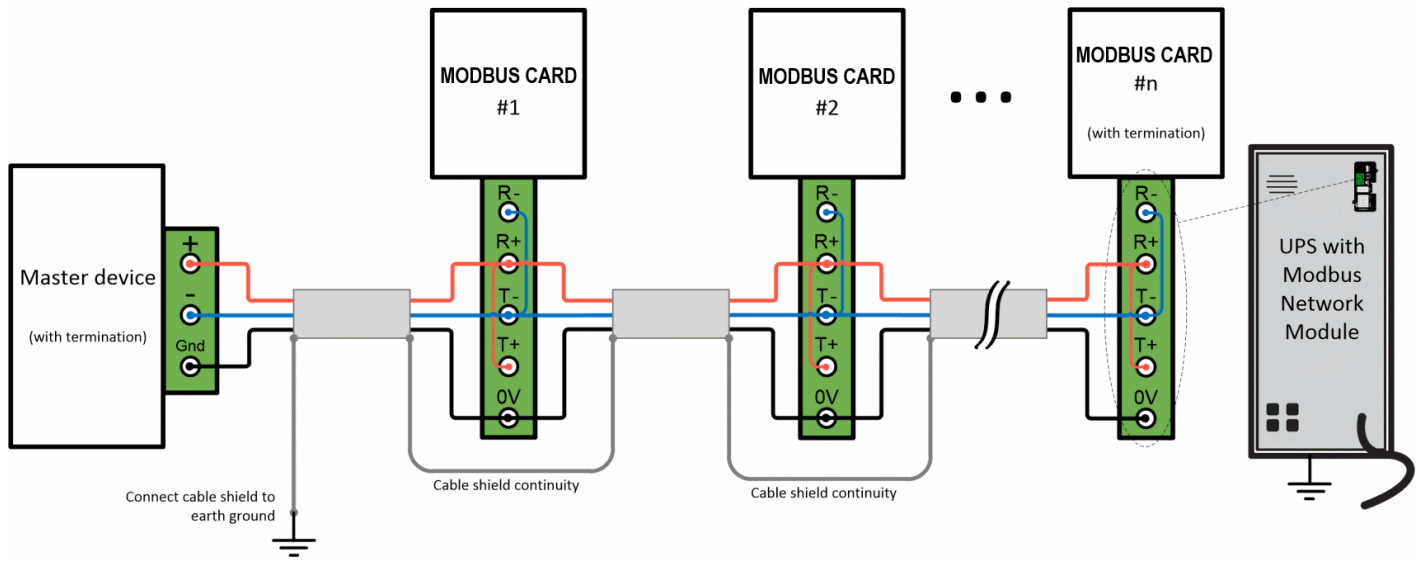

i Belden 3106A-22AWG or equivalent cabling (a 1.5 twisted-pair shielded 120Ω cable with ground) is recommended.

2.3.4 Four-wire networks

All four RS-485 network signals including T-, T+, R-, and R+ must be connected respectively to the terminal strip R-, R+, T-, T+.

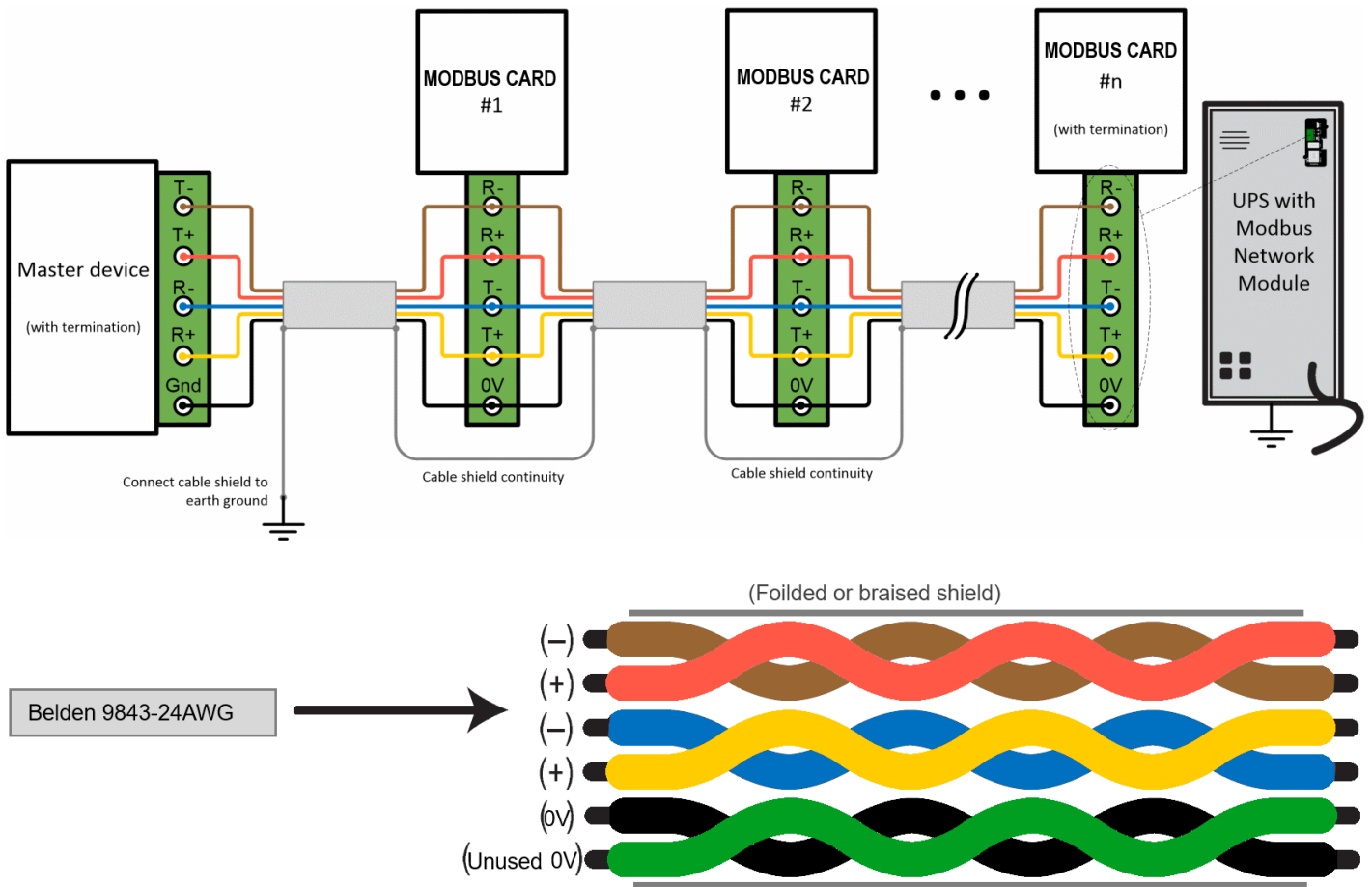

Belden 9843-24AWG or equivalent cabling (3 twisted-pair shielded 120Ω cable with ground) is recommended.

2.3.5 Configuring the termination

If the INDGW card is the last device installed in the network chain or the length of the network cable is excessive, termination needs to be enabled.

Termination is used to match impedance of a node to the impedance of the transmission line being used. When impedances are mismatched, the transmitted signal is not completely absorbed by the load and a portion is reflected into the transmission line.



No more than two termination points should be used in the RS-485 network.

To enable the on-board termination resistor (120Ω):

1. Locate the termination switch that is located on the top of the Modbus Network Module.

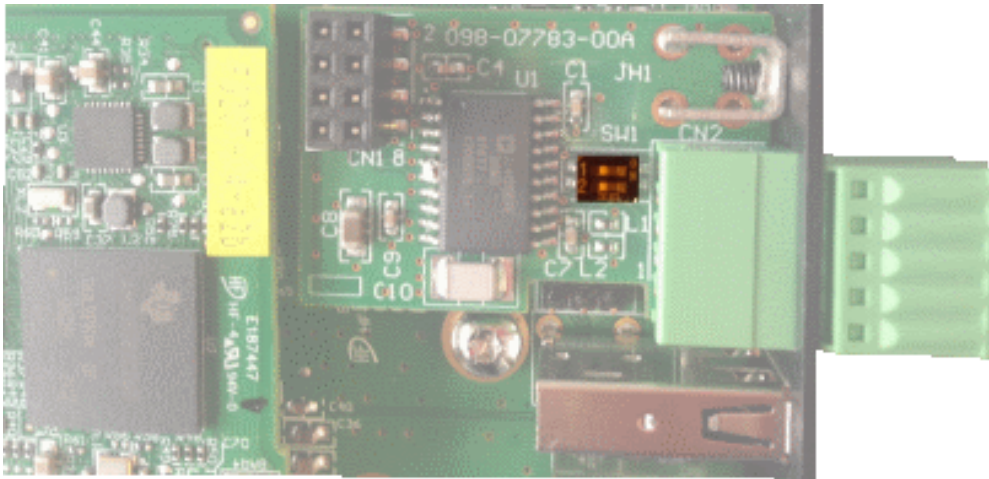

2. Peel off the protection:

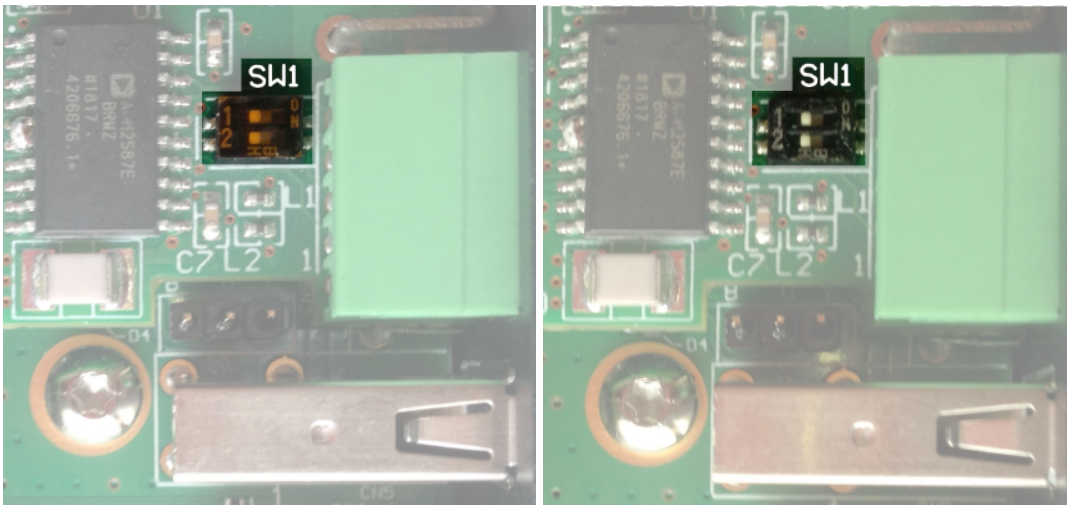

3. Change the position of the termination switch according to your needs:

	Switch position
No termination (default)	
Termination for <u>two-wire</u> networks	One of the two position below can be used: or

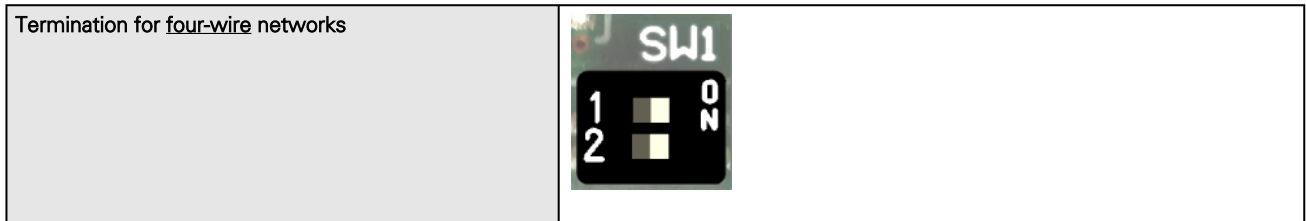

2.4 Accessing the Network Module

2.4.1 Accessing the web interface through Network

2.4.1.1 Connecting the network cable



Security settings in the Network Module may be in their default states. For maximum security, configure through a USB connection before connecting the network cable.

Connect a standard *gigabit compatible shielded ethernet cable (F/UTP or F/FTP)* between the network connector on the Network Module and a network jack.

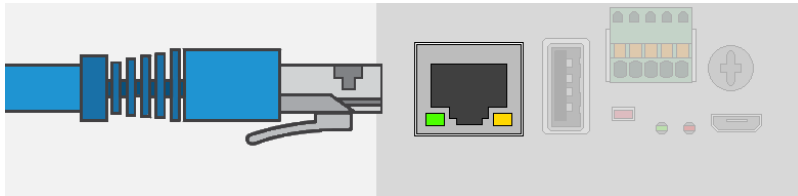

2.4.1.2 Accessing the web interface



It is highly recommended that browser access to the Network Module is isolated from outside access using a firewall or isolated network.

STEP 1 – On a network computer, launch a supported web browser. The browser window appears.

STEP 2 – In the Address/Location field, enter `https://[IP address]` with the static IP address of the Network Module.

STEP 3 – The login screen appears.

STEP 4 – Enter the user name in the User Name field. The default user name is **admin**.

STEP 5 – Enter the password in the Password field. The default password is **admin**.

STEP 6 – The password must be changed at first login.

STEP 7 – Click **Login**. The Network Module web interface appears.

2.4.2 Finding and setting the IP address

2.4.2.1 Your network is equipped with a BOOTP/DHCP server (default)

2.4.2.1.1 Read from the device LCD



Note: some older Devices may not be able to display the IP address even if they have an LCD. Please consult the Device manual.

If your device has an LCD, from the LCD's menu, navigate to Identification>>>"COM card IPv4".

- Note the IP address of the card.
- Go to the section: Accessing the web interface through Network.

2.4.2.1.2 With web browser through the configuration port

For example, if your device does not have an LCD, the IP address can be discovered by accessing the web interface through RNDIS and browsing to Settings>Network.

To access the web interface through RNDIS, see the [Accessing the web interface through RNDIS](#) section.

- Navigate to [Contextual help>>>Settings>>>Network & Protocol>>>IPv4](#).
- Read the IPv4 settings.

2.4.2.2 Your network is not equipped with a BOOTP/DHCP server

2.4.2.2.1 Define from the configuration port

The IP address can be defined by accessing the web interface through RNDIS.

To access web interface through RNDIS, see the [Accessing the web interface through RNDIS](#) section.

Define the IP settings:

- Navigate to [Contextual help>>>Settings>>>Network & Protocol>>>IPv4](#).
- Select Manual (Static IP).
- Input the following information: Address, Subnet Mask, Default Gateway
- Save the changes.

2.4.3 Accessing the web interface through RNDIS

This connection is used to access and configure the Network Module network settings locally through a RNDIS (Ethernet over USB interface).

2.4.3.1 Connecting the configuration cable

1. Connect the Micro-B to USB cable to a USB connector on the host computer.
2. Connect the cable to the Settings connector on the Network Module.

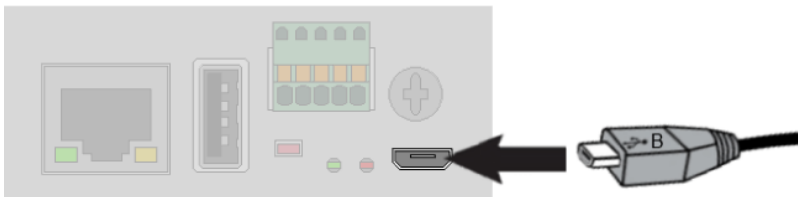

2.4.3.2 Web interface access through RNDIS

2.4.3.2.1 Configuring the RNDIS

a Automatic configuration



RNDIS driver is used to emulate a network connection from USB.

After the card is connected to the PC, **Windows®** OS will automatically search for the RNDIS driver.

On many computers, the OS can find the RNDIS driver automatically, configuration is completed, and you can go to Accessing the web interface.

On some computers, the OS can find the RNDIS driver then configuration is completed, and you can go to Accessing the web interface. If it fails, try another USB port on your computer.

If the automatic procedure fails proceed to manual configuration.

b Manual configuration

STEP 1 – In case **Windows®** OS fails to find driver automatically, go to the Windows control panel>Network and sharing center>Local area connection

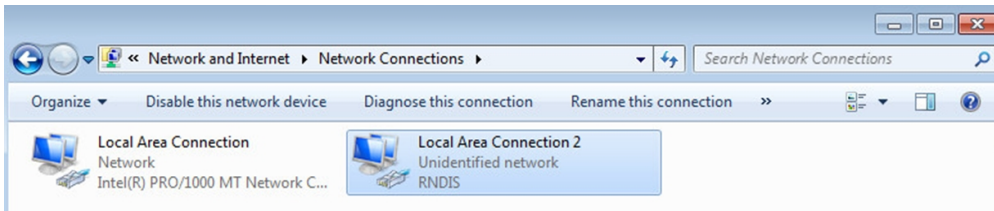

STEP 2 – Right click on the RNDIS local area connection and select Properties.

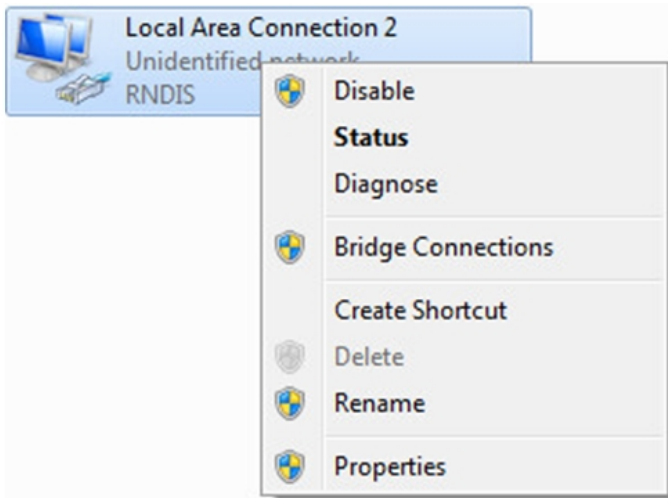

STEP 3 – Select Internet Protocol Version 4 (TCP/IPv4) and press the Properties button

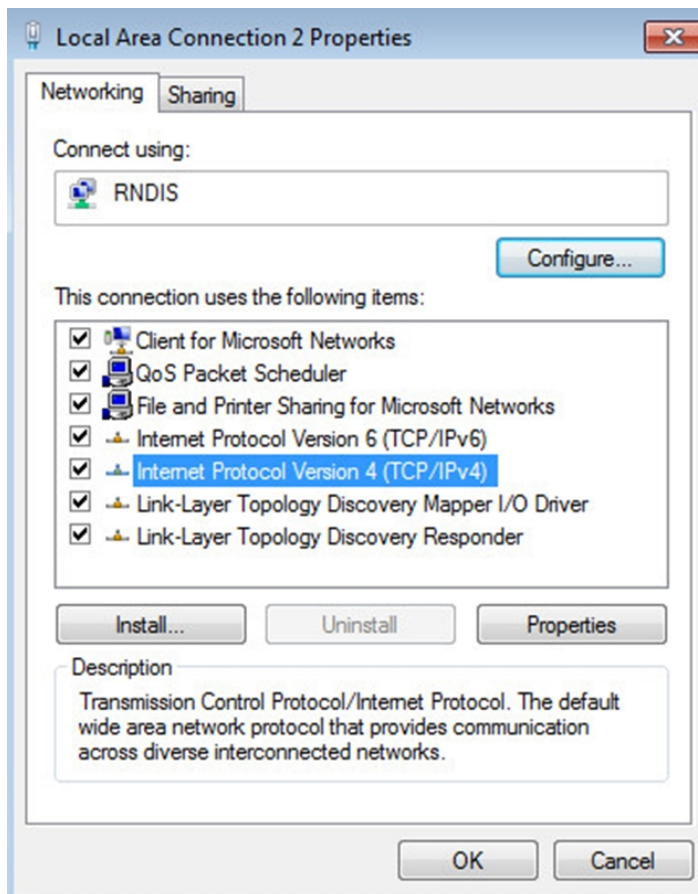

STEP 4 – Then enter the configuration as below and validate (IP = 169.254.0.150 and mask = 255.255.0.0), click OK, then click on Close.

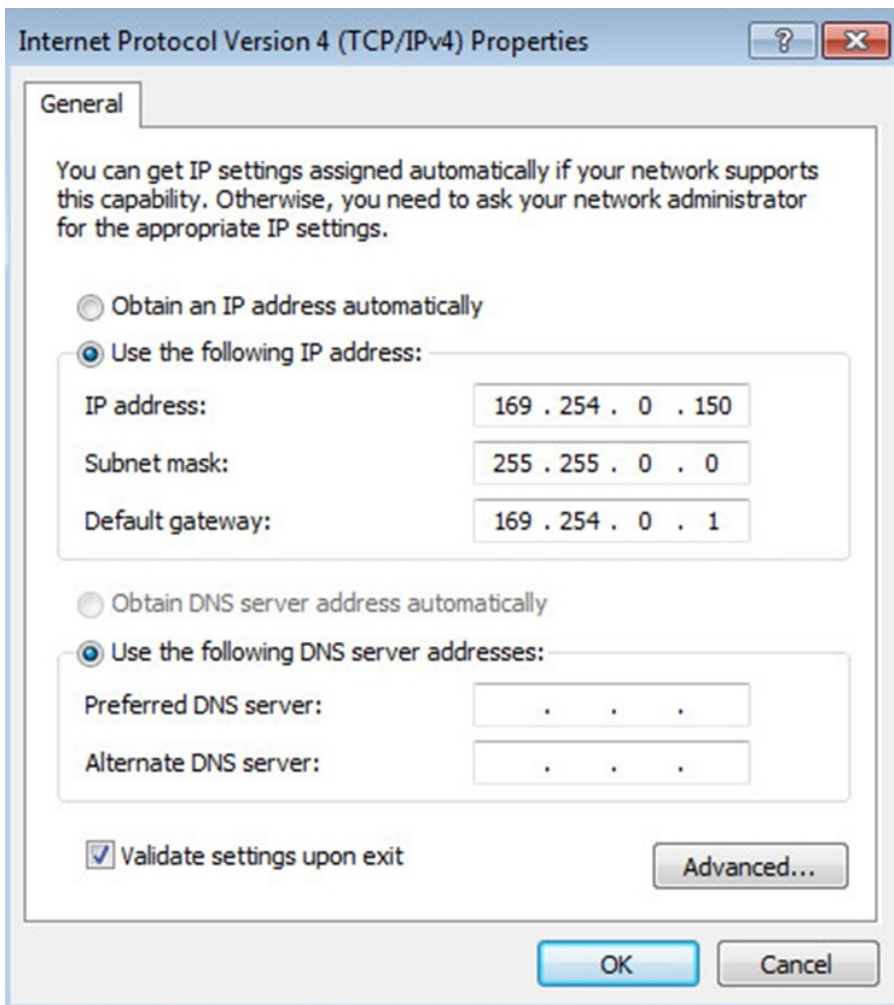

2.4.3.2.2 Accessing the web interface

STEP 1 – Be sure that the Device is powered on.

STEP 2 – On the host computer, download the rndis.7z file from the website www.eaton.com/downloads and extract it. For more information, navigate to [Servicing the Network Management Module>>>Accessing to the latest Network Module firmware/driver](#) section.

STEP 3 – Launch setProxy.bat to add 169.254.* in proxy’s exceptions list, if needed. For manual configuration, navigate to [Installing the Network Management Module>>>Accessing the Network Module>>>Modifying the Proxy exception list](#) section in the full documentation.

STEP 4 – Launch a supported browser, the browser window appears.

STEP 5 – In the Address/Location field, enter: **https://169.254.0.1**, the static IP address of the Network Module for RNDIS. The log in screen appears.

STEP 6 – Enter the user name in the User Name field. The default user name is **admin**.

STEP 7 – Enter the password in the Password field. The default password is **admin**.

STEP 8 – Click **Login**. The Network Module local web interface appears.

2.4.4 Accessing the card through serial terminal emulation

This connection is used to access and configure the Network Module network settings locally through Serial (Serial over USB interface).

2.4.4.1 Connecting the configuration cable

STEP 1 – Connect the Micro-B to USB cable to a USB connector on the host computer.

STEP 2 – Connect the cable to the Settings connector on the Network Module.

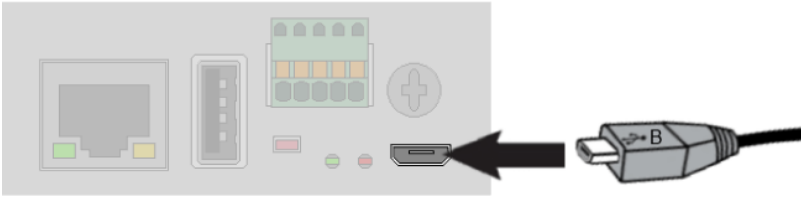

2.4.4.2 Manual configuration of the serial connection



Serial driver is used to emulate a serial connection from USB. After the card is connected to the PC, manual configuration of the driver is needed for **Windows®** OS to discover the serial connection.

STEP 1 – On the host computer, download the rndis.7z file from the website www.eaton.com/downloads and extract it.

STEP 2 – Plug the USB cable and go to **Windows®** Device Manager.

STEP 3 – Check the CDC Serial in the list, if it is with a yellow exclamation mark implying that driver has not been installed follow the steps 4-5-6-7 otherwise configuration is OK.

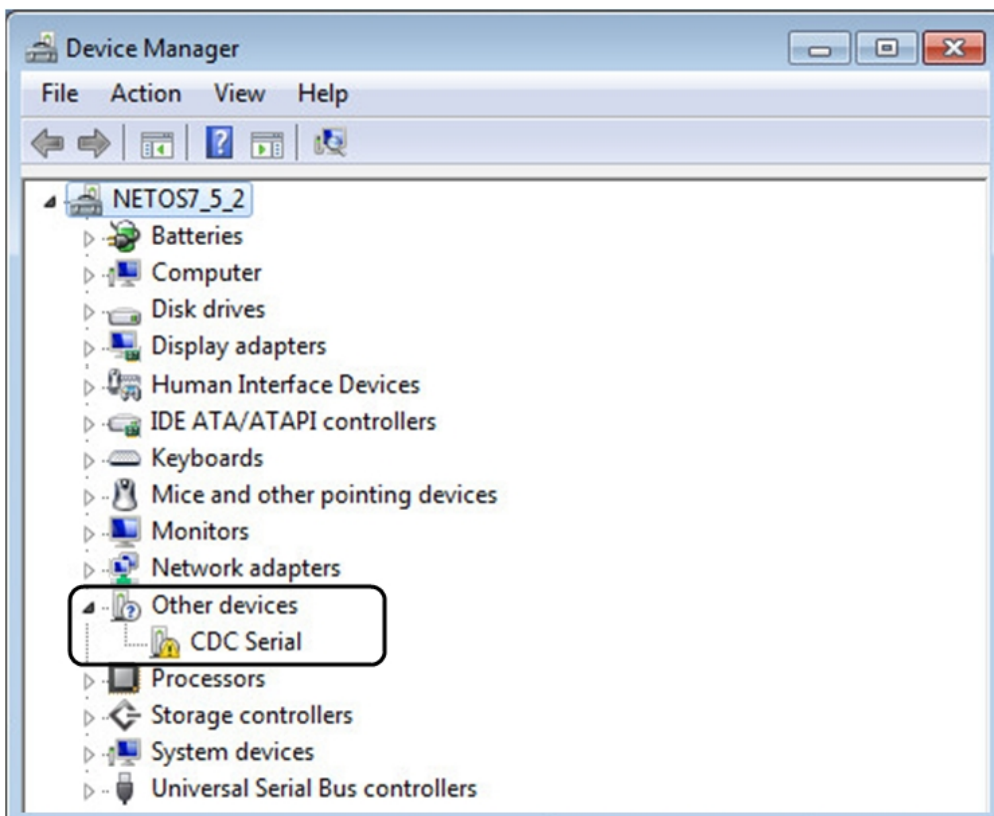

STEP 4 – Right click on it and select Update Driver Software. When prompted to choose how to search for device driver software, choose Browse my computer for driver software. Select Let me pick from a list of device drivers on my computer.

STEP 5 – Select the folder where you have previously downloaded the driver file Click on Next.

STEP 6 – A warning window will come up because the driver is not signed. Select Install this driver software anyway

STEP 7 – The installation is successful when the COM port number is displayed for the Gadget Serial device in the **Windows®** Device Manager.

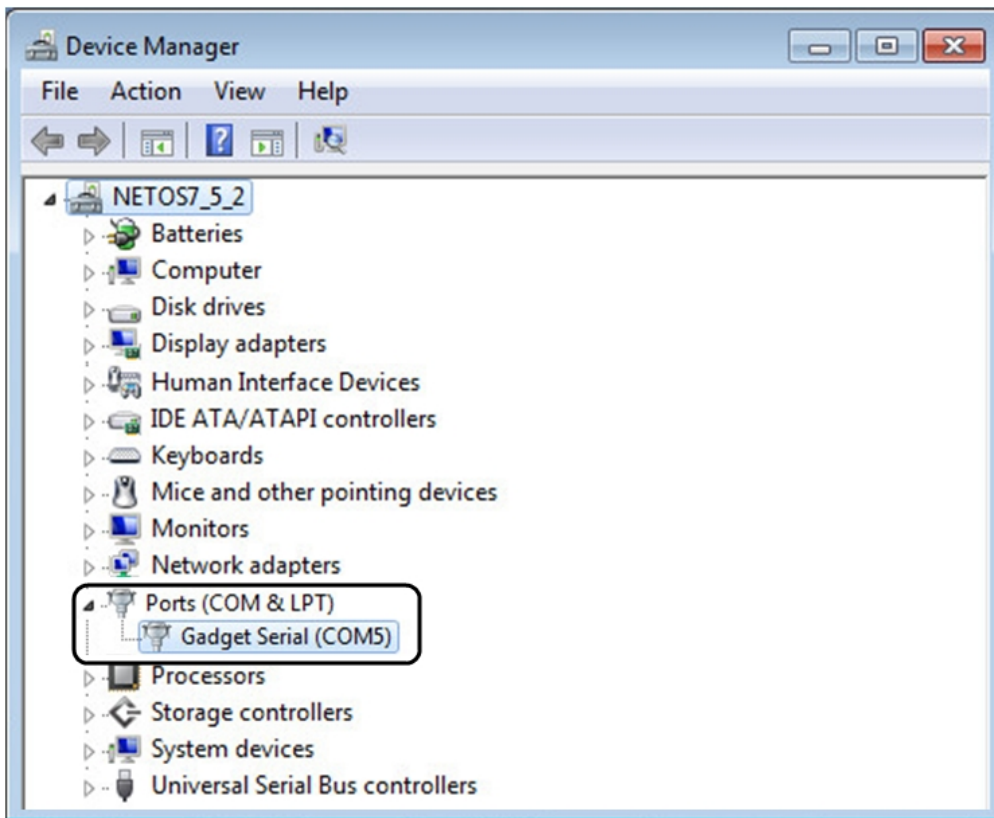

2.4.4.3 Accessing the card through Serial

It is intended mainly for automated configuration of the network and time settings of the network card. It can also be used for troubleshooting and remote reboot/reset of the network interface in case the web user interface is not accessible.

CLI can be accessed through:

- SSH
- Serial terminal emulation.



Changing network parameters may cause the card to become unavailable remotely. If this happens it can only be reconfigured locally through USB.



You can see this list of available commands by typing in the CLI: `?`
 You can see the help by typing in the CLI: `help`

For more details, refer to [Information>>>CLI](#) section

2.4.5 Modifying the Proxy exception list

To connect to the Network Module via a USB cable and your system uses a Proxy server to connect to the internet, the proxy settings can reject the IP address 169.254.0.1.

The 169.254.* Sequence is used to set up communication with devices via a physical connection.

To activate this connection, exceptions will have to be made in the proxy settings.

- Open Internet Explorer
- Navigate to settings, Internet options;

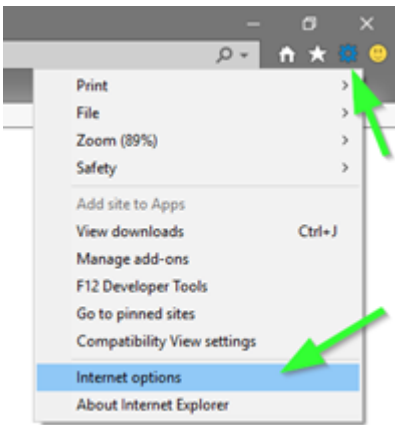

- Select the Connections tab
- Press LAN Settings

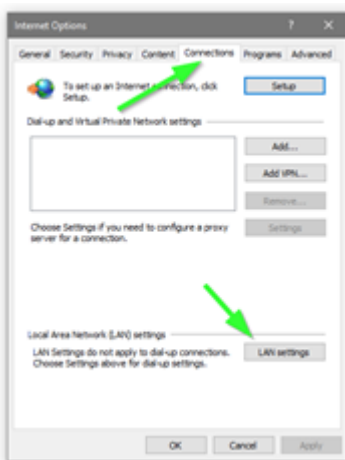

- Press ADVANCED



- Add the address 169.254. *

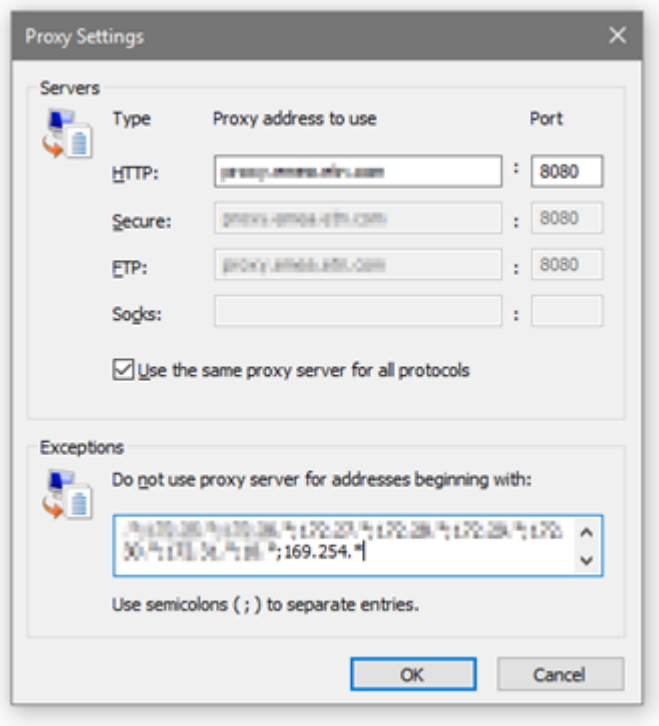

- Press OK.
- Close Internet Explorer and re-open it.
- Now you can access the address 169.254.0.1 with Internet Explorer and any other browser.

2.5 Configuring Modbus

2.5.1 Configuring the communication parameters

- Access the web interface through Network or RNDIS
- Navigate to [Contextual help>>>Settings>>>Modbus](#) and set the communication parameters to the desired settings.



For Modbus RTU configuration refer to the section [Contextual help>>>Settings>>>Modbus>>>Modbus RTU](#).



For Modbus TCP configuration refer to the section [Contextual help>>>Settings>>>Modbus>>>Modbus TCP](#).

2.5.2 Available maps

- Access the web interface through Network or RNDIS
- Navigate to [Contextual help>>>Settings>>>Modbus](#) and press the **Supported MAPs** button to download the MAPs.



File is generated in real time and will take into account the device capabilities and values at the time of the generation.
Table in the downloaded file will show all possible registers, only the one showing Available equal to True will be supported by your system. The units used on Modbus map belong to the International System of Units, temperatures are expressed in Kelvin for example.

2.5.2.1 Mapping table content

- address (hex): register address in hexadecimal

- address (1-base): register address in 1-base format
- Type: Register/Discrete
- Size in bytes
- Number of modbus registers
- Writable: True/False
- Representation: Int16/UInt16/String/Boolean/...
- Name
- Description
- Unit (Kelvin, A, V, W, VA, %, Hz, min, ...)
- Status to 0: status when the discrete equal 0
- Status to 1: status when the discrete equal 1
- Available: True/False – Shows if the register is available on current device
- Value: Shows current value of the register on current device



For an example of supported Modbus mapping, navigate to [Installing the Network Management Module>>>Configuring Modbus>>>Example of supported Modbus mapping](#).

2.5.3 Modbus communication monitoring tool

- Access the CLI through SSH or the Serial terminal emulation
- Get available commands by typing ? in the CLI

CLI commands can be used to retrieve Modbus communication statistics, see [Information>>>CLI>>>modbus_statistics](#) section for more details.

2.5.4 Example of supported Modbus mapping

The following table is an example of the mapping information that can be retrieved in the Modbus settings by pressing the **Supported MAPs** button.

Configuring Modbus

address (hex)	address (1-base)	Type	Size in bytes	Number of modbus registers	Writable	Representation	Name	Description	Unit	Status to 0	Status to 1	Available	Value
0x100	256	Register	2	1	FALSE	Int16	Current phase 1 main 1	Input phase 1 current	A			FALSE	
0x101	257	Register	2	1	FALSE	Int16	Current phase 2 main 1	Input phase 2 current	A			FALSE	
0x103	259	Register	2	1	FALSE	Int16	Current phase 3 main 1	Input phase 3 current	A			FALSE	
0x106	262	Register	2	1	FALSE	Int16	Current phase 1 main 2	Bypass input phase 1 current	A			TRUE	0
0x107	263	Register	2	1	FALSE	Int16	Current phase 2 main 2	Bypass input phase 2 current	A			FALSE	
0x108	264	Register	2	1	FALSE	Int16	Current phase 3 main 2	Bypass input phase 3 current	A			FALSE	
0x109	265	Register	2	1	FALSE	Int16	Current phase 1 output	Output phase 1 current	A			TRUE	0
0x10a	266	Register	2	1	FALSE	Int16	Current phase 2 output	Output phase 2 current	A			FALSE	
0x10b	267	Register	2	1	FALSE	Int16	Current phase 3 output	Output phase 3 current	A			FALSE	
0x10e	270	Register	2	1	FALSE	Int16	Battery Current	Battery current	A			FALSE	
0x111	273	Register	2	1	FALSE	UInt16	Normal value active power	Normal value active power	W			TRUE	1500
0x115	277	Register	2	1	FALSE	Int16	U12 main 1	Input voltage between phases 1 and 2	V			FALSE	
0x116	278	Register	2	1	FALSE	Int16	U23 main 1	Input voltage between phases 2 and 3	V			FALSE	
0x117	279	Register	2	1	FALSE	Int16	U31 main 1	Input voltage between phases 3 and 1	V			FALSE	
0x11e	286	Register	2	1	FALSE	Int16	Voltage phase 1 main 2	Bypass input phase 1 voltage	V			TRUE	235
0x11f	287	Register	2	1	FALSE	Int16	Voltage phase 2 main 2	Bypass input phase 2 voltage	V			FALSE	
0x120	288	Register	2	1	FALSE	Int16	Voltage phase 3 main 2	Bypass input phase 3 voltage	V			FALSE	
0x120	288	Register	2	1	FALSE	Int16	Voltage phase 3 main 2	Bypass input phase 3 voltage	V			FALSE	
0x121	289	Register	2	1	FALSE	Int16	U12 main 2	Bypass input voltage between phases 1 and 2	V			FALSE	
0x122	290	Register	2	1	FALSE	Int16	U23 main 2	Bypass input voltage between phases 2 and 3	V			FALSE	
0x123	291	Register	2	1	FALSE	Int16	U31 main 2	Bypass input voltage between phases 3 and 1	V			FALSE	
0x124	292	Register	2	1	FALSE	Int16	Output voltage 1N	Output phase 1 voltage	V			TRUE	230
0x125	293	Register	2	1	FALSE	Int16	Output voltage 2N	Output phase 2 voltage	V			FALSE	
0x126	294	Register	2	1	FALSE	Int16	Output voltage 3N	Output phase 3 voltage	V			FALSE	
0x127	295	Register	2	1	FALSE	Int16	Output voltage 12	Output voltage between phases 1 and 2	V			FALSE	
0x128	296	Register	2	1	FALSE	Int16	Output voltage 23	Output voltage between phases 2 and 3	V			FALSE	
0x129	297	Register	2	1	FALSE	Int16	Output voltage 31	Output voltage between phases 3 and 1	V			FALSE	
0x12d	301	Register	2	1	FALSE	Int16	Battery Voltage	Battery voltage	V			TRUE	55
0x130	304	Register	2	1	FALSE	Int16	Output active power phase 1	Output active power phase 1	W			TRUE	0
0x131	305	Register	2	1	FALSE	Int16	Output active power phase 2	Output active power phase 2	W			FALSE	

address (hex)	address (1-base)	Type	Size in bytes	Number of modbus registers	Writable	Representation	Name	Description	Unit	Status to 0	Status to 1	Available	Value
0x132	306	Register	2	1	FALSE	Int16	Output active power phase 3	Output active power phase 3	W			FALSE	
0x133	307	Register	2	1	FALSE	Int16	Output apparent power phase 1	Output apparent power phase 1	VA			TRUE	0
0x134	308	Register	2	1	FALSE	Int16	Output apparent power phase 2	Output apparent power phase 2	VA			FALSE	
0x135	309	Register	2	1	FALSE	Int16	Output apparent power phase 3	Output apparent power phase 3	VA			FALSE	
0x136	310	Register	2	1	FALSE	UInt16	Output total active power	Output total active power	W			TRUE	0
0x137	311	Register	2	1	FALSE	UInt16	Output total apparent power	Output total apparent power	VA			TRUE	0
0x139	313	Register	2	1	FALSE	UInt16	% output load level	Output percent load level	%			TRUE	0
0x13a	314	Register	2	1	FALSE	Int16	Peak factor phase 1 x 100	Peak factor phase 1 x 100	-			FALSE	
0x13b	315	Register	2	1	FALSE	Int16	Peak factor phase 2 x 100	Peak factor phase 2 x 100	-			FALSE	
0x13c	316	Register	2	1	FALSE	Int16	Peak factor phase 3 x 100	Peak factor phase 3 x 100	-			FALSE	
0x13d	317	Register	2	1	FALSE	UInt16	Power factor x 100	Power factor x 100	-			TRUE	0
0x13e	318	Register	2	1	FALSE	Int16	Main 1 frequency	Input frequency	Hz			TRUE	50
0x140	320	Register	2	1	FALSE	Int16	Main 2 frequency	Bypass input frequency	Hz			TRUE	50
0x141	321	Register	2	1	FALSE	Int16	Output frequency	Output frequency	Hz			TRUE	50
0x149	329	Register	2	1	FALSE	Int16	Battery backup time	Battery backup time	Min			TRUE	0
0x14b	331	Register	2	1	FALSE	UInt16	Battery charging level	Battery charging level	%			TRUE	100
0x150	336	Register	2	1	FALSE	Int16	Voltage main 1 phase 1	Input voltage phase 1	V			TRUE	234
0x151	337	Register	2	1	FALSE	Int16	Voltage main 1 phase 2	Input voltage phase 2	V			FALSE	
0x152	338	Register	2	1	FALSE	Int16	Voltage main 1 phase 3	Input voltage phase 3	V			FALSE	
0x1a0	416	Register	14	7	FALSE	String	Manufacturer Name	Manufacturer name				TRUE	xxxxx
0x1a8	424	Register	14	7	FALSE	String	Product Name	Product name				TRUE	xxxxx
0x1b0	432	Register	14	7	FALSE	String	UPS Model	UPS model				TRUE	xxxxx
0x1b8	440	Register	14	7	FALSE	String	Serial Number	Serial number				TRUE	xxxxx
0x1c0	448	Register	14	7	FALSE	String	Part Number	Part number				TRUE	xxxxx
0x209	521	Register	2	1	FALSE	UInt16	Nominal value apparent power	Nominal value apparent power	VA			TRUE	1500
0x213	531	Register	2	1	FALSE	Int16	Nominal voltage of battery element	Nominal voltage of battery element	V			TRUE	48
0x400	1024	Discrete	1	1	FALSE	See Description	Load protected status	Load protected status		Load not protected	Load protected	TRUE	1
0x401	1025	Discrete	1	1	FALSE	Boolean	UPS coupled	UPS coupled status		UPS not coupled	UPS coupled	TRUE	1
0x402	1026	Discrete	1	1	FALSE	Boolean	Unit general alarm	Unit general alarm status		Unit no general alarm	Unit general alarm	TRUE	0
0x403	1027	Discrete	1	1	FALSE	Boolean	Configuration firmware fault	Configuration firmware fault status		Configuration firmware ok	Configuration firmware fault	TRUE	0
0x404	1028	Discrete	1	1	FALSE	See Description	UPS in backup status	UPS in backup status		UPS not in backup	UPS in backup	TRUE	0
0x405	1029	Discrete	1	1	FALSE	Boolean	Battery low warning	Battery low warning status		Battery ok	Battery low warning	TRUE	0
0x406	1030	Discrete	1	1	FALSE	Boolean	Low battery	Low battery status		Battery ok	Low battery	TRUE	0
0x407	1031	Discrete	1	1	FALSE	Boolean	Operation on static switch	Operation on static switch status		Operation not on static switch	Operation on static switch	FALSE	

Configuring Modbus

address (hex)	address (1-base)	Type	Size in bytes	Number of modbus registers	Writable	Representation	Name	Description	Unit	Status to 0	Status to 1	Available	Value
0x409	1033	Discrete	1	1	FALSE	Boolean	Communication fault	Communication fault status		Communication ok	Communication fault	TRUE	0
0x40a	1034	Discrete	1	1	FALSE	Boolean	UPS overload	UPS overload status		UPS no overload	UPS overload	TRUE	0
0x40b	1035	Discrete	1	1	FALSE	Boolean	Emergency stop	Emergency stop status		No emergency stop	Emergency stop	TRUE	0
0x40d	1037	Discrete	1	1	FALSE	Boolean	Battery to be checked	Battery to be checked status		Battery not to be checked	Battery to be checked	TRUE	0
0x40e	1038	Discrete	1	1	FALSE	Boolean	Device verification fault	Device verification fault status		Device verification ok	Device verification fault	TRUE	0
0x411	1041	Discrete	3	3	FALSE	See Description	Ups Class	001: Off line / Line interactive 011: On line - unitary/parallel 100: On line - parallel with NS 101: On line - hot standby redundancy 000: Unknown				TRUE	11
0x415	1045	Discrete	1	1	FALSE	Boolean	Manual bypass present	Manual bypass present status		Manual bypass absent	Manual bypass present	FALSE	
0x416	1046	Discrete	1	1	FALSE	Boolean	Manual bypass switch	Manual bypass switch status		Manual bypass switch closed	Manual bypass switch opened	FALSE	
0x417	1047	Discrete	1	1	FALSE	Boolean	Mode ECO = 1	High efficiency mode		Not on high efficiency mode	On high efficiency mode	FALSE	
0x420	1056	Discrete	1	1	FALSE	Boolean	Battery present	Battery present status		Battery absent	Battery present	TRUE	1
0x421	1057	Discrete	1	1	FALSE	Boolean	Battery voltage unbalanced	Battery voltage unbalanced status		Battery voltage not unbalanced	Battery voltage unbalanced	FALSE	
0x422	1058	Discrete	1	1	FALSE	See Description	Battery test fault	Battery test result		Battery test ok	Battery test fault	TRUE	1
0x42a	1066	Discrete	1	1	FALSE	Boolean	Battery over temperature	Battery over temperature status		Battery normal temperature	Battery over temperature	FALSE	
0x42b	1067	Discrete	1	1	FALSE	Boolean	Battery fuse fault	Battery fuse fault status		Battery fuse ok	Battery fuse fault	FALSE	
0x42d	1069	Discrete	1	1	FALSE	Boolean	Battery over temperature	Battery over temperature status		Battery normal temperature	Battery over temperature	FALSE	
0x42e	1070	Discrete	1	1	FALSE	Boolean	Circuit breaker fuse fault	Circuit breaker fuse fault status		Circuit breaker fuse ok	Circuit breaker fuse fault	TRUE	0
0x42f	1071	Discrete	1	1	FALSE	Boolean	Circuit breaker QF1 status	Circuit breaker QF1 status		Circuit breaker QF1 opened	Circuit breaker QF1 closed	FALSE	
0x433	1075	Discrete	1	1	FALSE	Boolean	Time expired	Time expired status		Time not expired	Time expired	TRUE	0
0x440	1088	Discrete	1	1	FALSE	Boolean	Buck mode	Buck mode status		Not on buck mode	On buck mode	FALSE	
0x441	1089	Discrete	1	1	FALSE	Boolean	Boost mode	Boost mode status		Not on boost mode	On boost mode	FALSE	
0x442	1090	Discrete	1	1	FALSE	Boolean	Wiring fault	Wiring fault status		Wiring ok	Wiring fault	TRUE	0
0x443	1091	Discrete	1	1	FALSE	Boolean	Circuit breaker Q1 status	Circuit breaker Q1 status		Circuit breaker Q1 opened	Circuit breaker Q1 closed	FALSE	
0x448	1096	Discrete	1	1	FALSE	See Description	Main 1 voltage out of tolerance	Main 1 voltage out of tolerance		Input voltage is into the tolerance	Input voltage is out of tolerance	TRUE	0
0x449	1097	Discrete	1	1	FALSE	Boolean	Main 1 fuse fault	Main 1 fuse fault status		Main 1 fuse ok	Main 1 fuse fault	TRUE	0
0x44a	1098	Discrete	1	1	FALSE	Boolean	Charger over temperature fault	Charger over temperature status		Charger over temperature ok	Charger over temperature fault	FALSE	
0x44b	1099	Discrete	1	1	FALSE	Boolean	Main 1 frequency out of tolerance	Main 1 frequency out of tolerance status		Main 1 frequency not out of tolerance	Main 1 frequency out of tolerance	TRUE	0
0x457	1111	Discrete	1	1	FALSE	Boolean	Redundancy lost	Redundancy lost status		Redundancy not lost	Redundancy lost	FALSE	
0x461	1121	Discrete	1	1	FALSE	Boolean	Maintenance position	Maintenance position status		Not on maintenance position	On maintenance position	FALSE	
0x465	1125	Discrete	1	1	FALSE	Boolean	Main 2 overload	Main 2 overload status		Main 2 no overload	Main 2 overload	TRUE	0
0x466	1126	Discrete	1	1	FALSE	Boolean	Main 2 thermal overload	Main 2 thermal overload status		Main 2 thermal no overload	Main 2 thermal overload	FALSE	

address (hex)	address (1-base)	Type	Size in bytes	Number of modbus registers	Writable	Representation	Name	Description	Unit	Status to 0	Status to 1	Available	Value
0x467	1127	Discrete	1	1	FALSE	Boolean	Output on bypass	Output on bypass status		Output not on bypass	Output on bypass	TRUE	1
0x469	1129	Discrete	1	1	FALSE	Boolean	Main 2 frequency out of tolerance	Main 2 frequency out of tolerance status		Main 2 frequency not out of tolerance	Main 2 frequency out of tolerance	TRUE	0
0x46a	1130	Discrete	1	1	FALSE	Boolean	Main 2 voltage out of tolerance	Main 2 voltage out of tolerance status		Main 2 voltage not out of tolerance	Main 2 voltage out of tolerance	FALSE	
0x46b	1131	Discrete	1	1	FALSE	Boolean	Phase M2 out of tolerance	Phase M2 out of tolerance status		Phase M2 not out of tolerance	Phase M2 out of tolerance	TRUE	0
0x46e	1134	Discrete	1	1	FALSE	Boolean	Circuit breaker Q4S status	Circuit breaker Q4S status		Circuit breaker Q4S opened	Circuit breaker Q4S closed	FALSE	
0x470	1136	Discrete	1	1	FALSE	Boolean	Internal fault	Internal fault status		No internal fault	Internal fault	FALSE	
0x479	1145	Discrete	1	1	FALSE	Boolean	Main 2 internal fault	Main 2 internal fault status		Main 2 no internal fault	Main 2 internal fault	FALSE	
0x47b	1147	Discrete	1	1	FALSE	Boolean	Output switch status			Output switch opened	Output switch closed	FALSE	
0x490	1168	Discrete	1	1	FALSE	Boolean	Charger general fault	Charger general fault status		Charger no general fault	Charger general fault	TRUE	0
0x491	1169	Discrete	1	1	FALSE	Boolean	Battery charge	Battery charging status		Battery not charging	Battery charging	TRUE	1
0x493	1171	Discrete	1	1	FALSE	Boolean	Battery charge	Battery charging status		Battery not charging	Battery charging	TRUE	1
0x4a1	1185	Discrete	1	1	FALSE	Boolean	Chopper fault	Chopper fault status		Chopper ok	Chopper fault	TRUE	0
0x4a2	1186	Discrete	1	1	FALSE	Boolean	Rectifier short circuit	Rectifier short circuit status		Rectifier not onshort circuit	Rectifier on short circuit	TRUE	0
0x4c1	1217	Discrete	1	1	FALSE	Boolean	Inverter major fault	Inverter major fault status		Inverter ok	Inverter major fault	TRUE	0
0x4c2	1218	Discrete	1	1	FALSE	Boolean	Inverter overload	Inverter overload status		Inverter no overload	Inverter overload	TRUE	0
0x4c3	1219	Discrete	1	1	FALSE	Boolean	Inverter thermal overload	Inverter thermal overload status		Inverter no thermal overload	Inverter thermal overload	FALSE	
0x4c4	1220	Discrete	1	1	FALSE	Boolean	Inverter current limitation	Inverter current limitation status		Inverter no current limitation	Inverter current limitation	TRUE	0
0x4c5	1221	Discrete	1	1	FALSE	Boolean	UPS fuse fault	UPS fuse fault status		UPS fuse ok	UPS fuse fault	FALSE	
0x4ca	1226	Discrete	1	1	FALSE	Boolean	Inverter over temperature	Inverter over temperature status		Inverter no over temperature	Inverter over temperature	TRUE	0
0x4f1	1265	Discrete	1	1	FALSE	Boolean	Short circuit	Short circuit status		No short circuit	Short circuit	TRUE	0
0x501	1281	Discrete	1	1	FALSE	Boolean	Output voltage too high	Output voltage too high status		Output voltage not too high	Output voltage too high	FALSE	
0x502	1282	Discrete	1	1	FALSE	Boolean	Output voltage too low	Output voltage too low status		Output voltage not too low	Output voltage too low	FALSE	
0x503	1283	Discrete	1	1	FALSE	Boolean	Input voltage of bypass too high	Input voltage of bypass too high status		Input voltage of bypass not too high	Input voltage of bypass too high	FALSE	
0x504	1284	Discrete	1	1	FALSE	Boolean	Input voltage of bypass too low	Input voltage of bypass too low status		Input voltage of bypass not too low	Input voltage of bypass too low	FALSE	
0x505	1285	Discrete	1	1	FALSE	Boolean	Output frequency out of range	Output frequency out of range status		Output frequency not out of range	Output frequency out of range	FALSE	
0x506	1286	Discrete	1	1	FALSE	Boolean	Electronic power supply fault	Electronic power supply status		Electronic power supply ok	Electronic power supply fault	FALSE	
0x507	1287	Discrete	1	1	FALSE	Boolean	Bypass wiring fault	Bypass wiring fault status		Bypass wiring ok	Bypass wiring fault	FALSE	
0x508	1288	Discrete	1	1	FALSE	Boolean	Shutdown in progress	Shutdown in progress status		Shutdown not in progress	Shutdown in progress	FALSE	
0x509	1289	Discrete	1	1	FALSE	Boolean	Compatibility failure	Compatibility failure status		No compatibility failure	Compatibility failure	TRUE	0
0x50a	1290	Discrete	1	1	FALSE	Boolean	Rectifier used	Rectifier used status		Rectifier not used	Rectifier used	FALSE	

3 Contextual help of the web interface

3.1 Login page

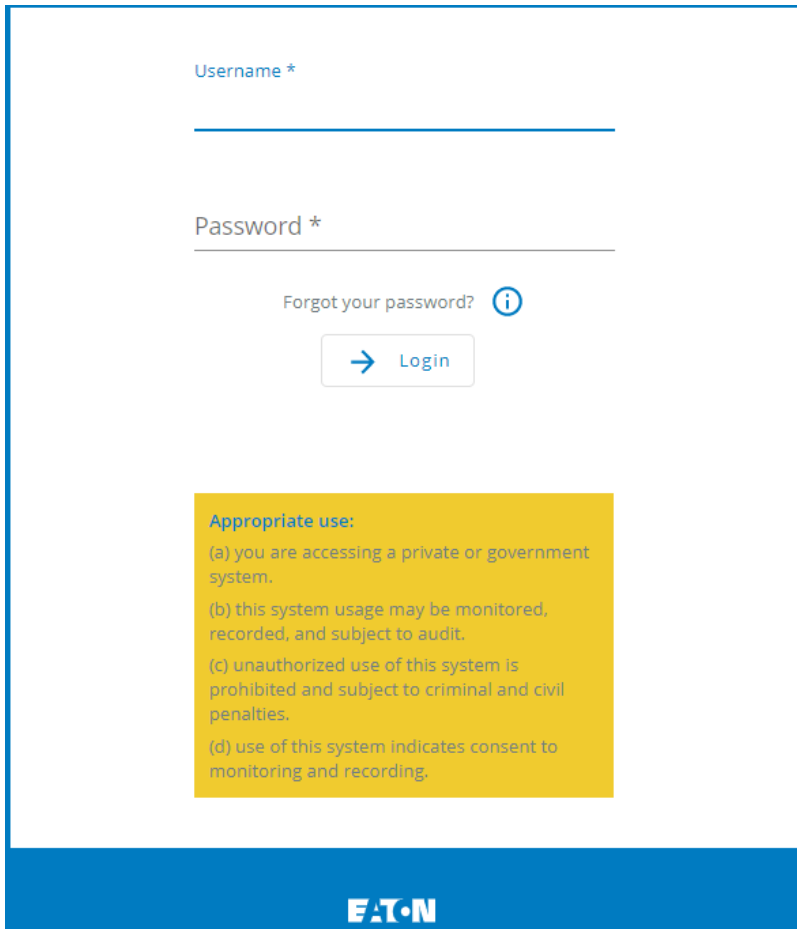

The screenshot shows a login page with the following elements:

- A text input field labeled "Username *".
- A text input field labeled "Password *".
- A link "Forgot your password?" with an information icon (i).
- A button with a right-pointing arrow and the text "Login".
- A yellow box containing the following text:
Appropriate use:
(a) you are accessing a private or government system.
(b) this system usage may be monitored, recorded, and subject to audit.
(c) unauthorized use of this system is prohibited and subject to criminal and civil penalties.
(d) use of this system indicates consent to monitoring and recording.
- The Eaton logo at the bottom.

The page language is set to English by default but can be switched to browser language when it is managed.

After navigating to the assigned IP address, accept the untrusted certificate on the browser.

3.1.1 Logging in for the first time

3.1.1.1 1. Enter default password

As you are logging into the Network Module for the first time you must enter the factory set default username and password.

- Username = admin
- Password = admin

3.1.1.2 2. Change default password

Changing the default password is mandatory and requested in a dedicated window.

Enter your current password first, and then enter the new password twice.

Follow the password format recommendations on the tooltip in order to define a secure password.

3.1.1.3 3. Accept license agreement

On the next step, License Agreement is displayed.

Read and accept the agreement to continue.

3.1.2 Troubleshooting

How do I log in if I forgot my password?

Action

- Ask your administrator for password initialization.
- If you are the main administrator, your password can be reset manually by following steps described in the [Servicing the Network Management Module>>>Recovering main administrator password](#) .

Web user interface is not up to date after a FW upgrade

Symptom

After an upgrade:

- The Web interface is not up to date
- New features of the new FW are not displayed
- An infinite spinner is displayed on a tile

Possible causes

The browser is displaying the Web interface through the cache that contains previous FW data.

Action

Empty the cache of your browser using F5 or CTRL+F5.

3.1.2.1 For other issues



For details on other issues, see the [Troubleshooting](#) section.

3.2 Home

The Home screen provides status information for the device including key measures and active alarms.

3.2.1 Menu structure

	Home: Overview and status of the Device (Active alarms, Outlet status, ...).
	Meters: Power quality meters and logs.
	Controls: Device and outlets control.
	Protection: Agents list, Agents shutdown sequencing, Shutdown on power outage.
	Environment: Commissioning/Status, Alarm configuration, Information.
	Settings: Network Module settings.
	Maintenance: Firmware, Services, Resources, System logs.
	Legal: Legal information, Availability of source code, Notice for proprietary elements.
	Profile: Displays user profile, password change, account information and logout.
	Help: Opens full documentation in a separate browser page.
	Alarms: Open alarm page and displays the number of active alarms.

3.2.2 Energy flow diagram examples

3.2.2.1 Online UPS with single input source

3.2.2.1.1 Online mode

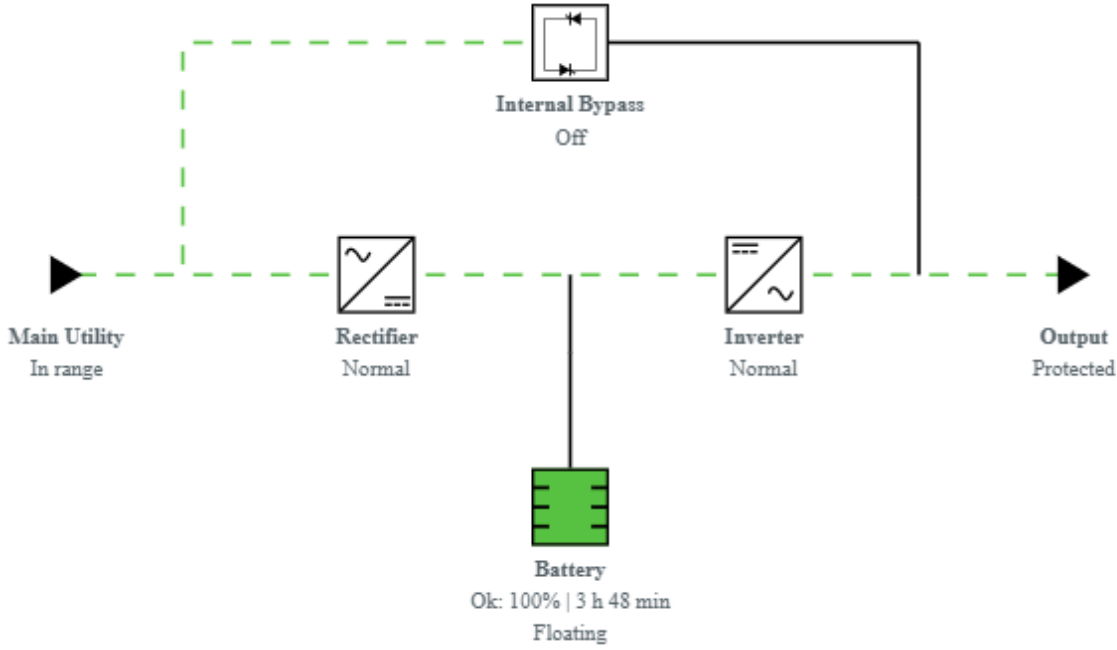

3.2.2.1.2 Bypass mode

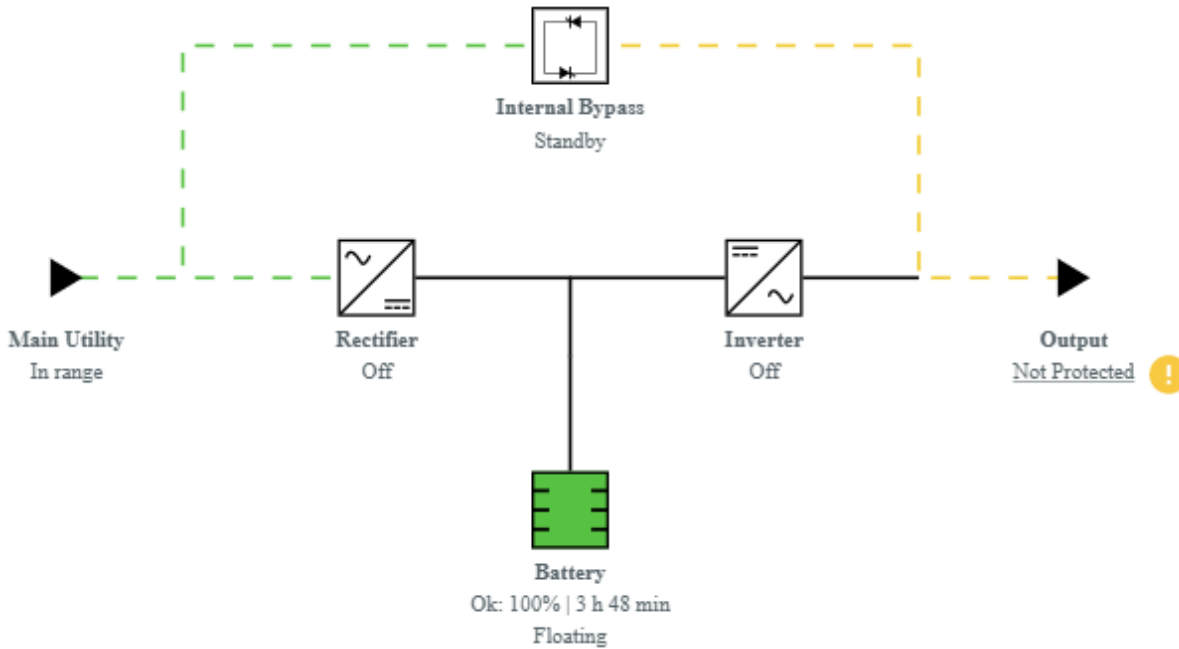

3.2.2.1.3 Battery mode

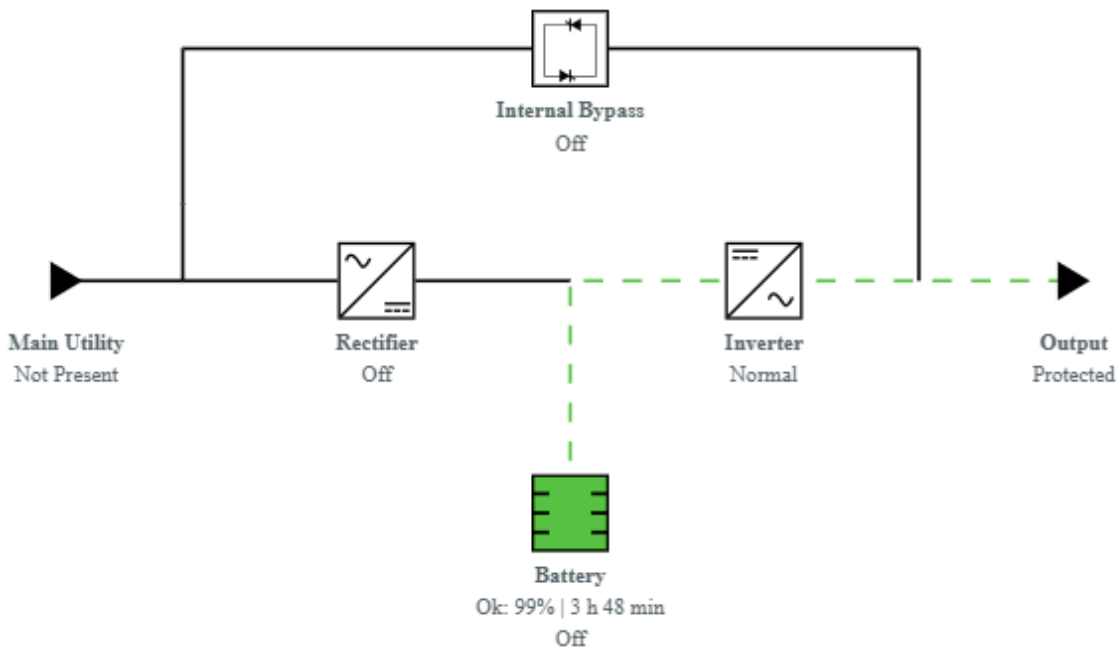

3.2.2.1.4 Off mode

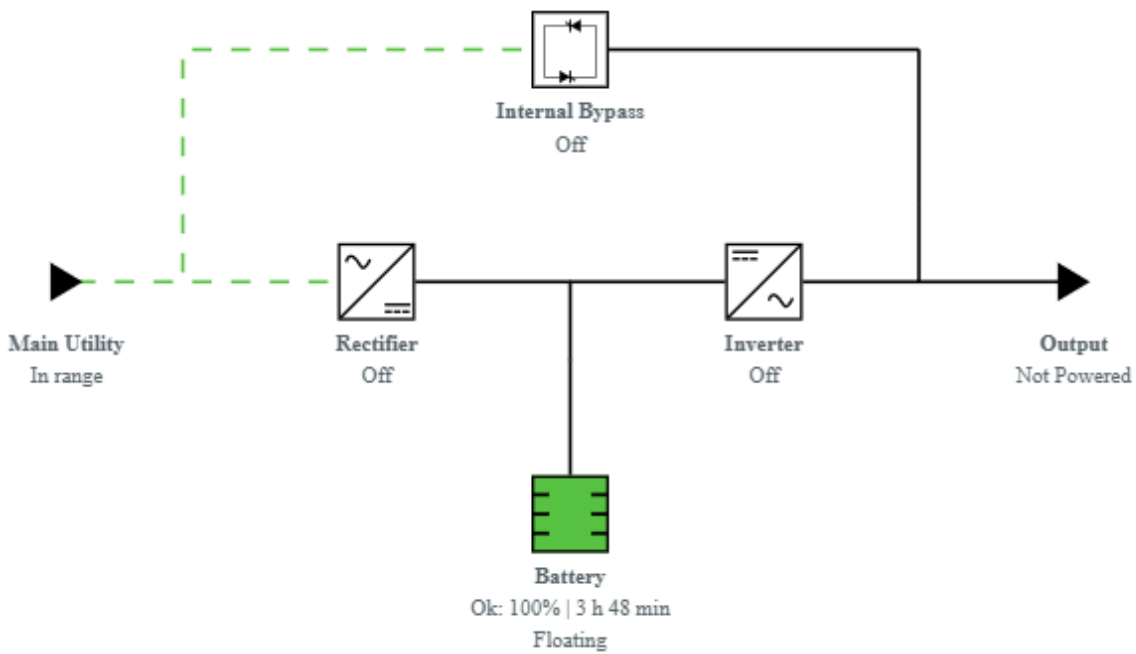

3.2.2.1.5 HE mode / ESS mode

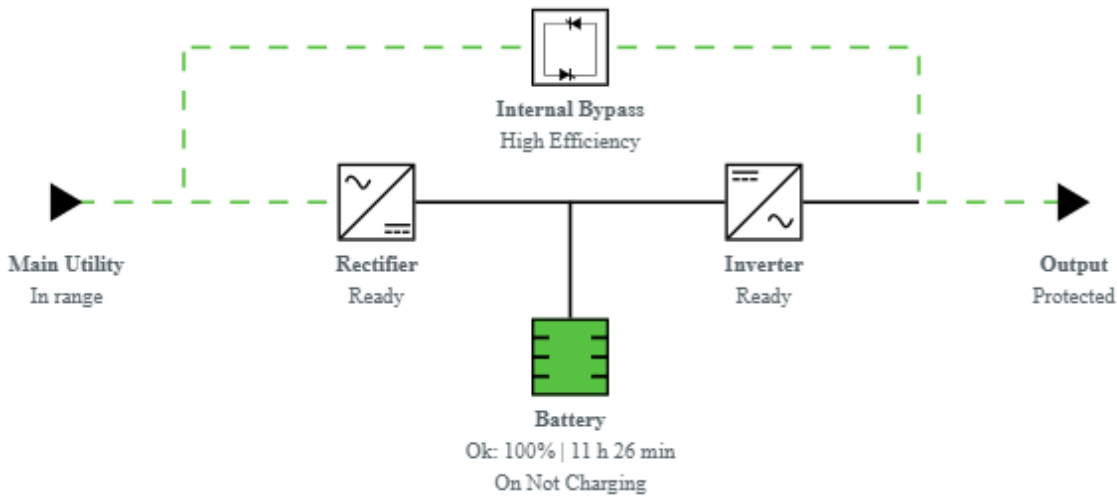

3.2.2.2 Online UPS with dual inputs sources and Maintenance bypass

3.2.2.2.1 Online mode

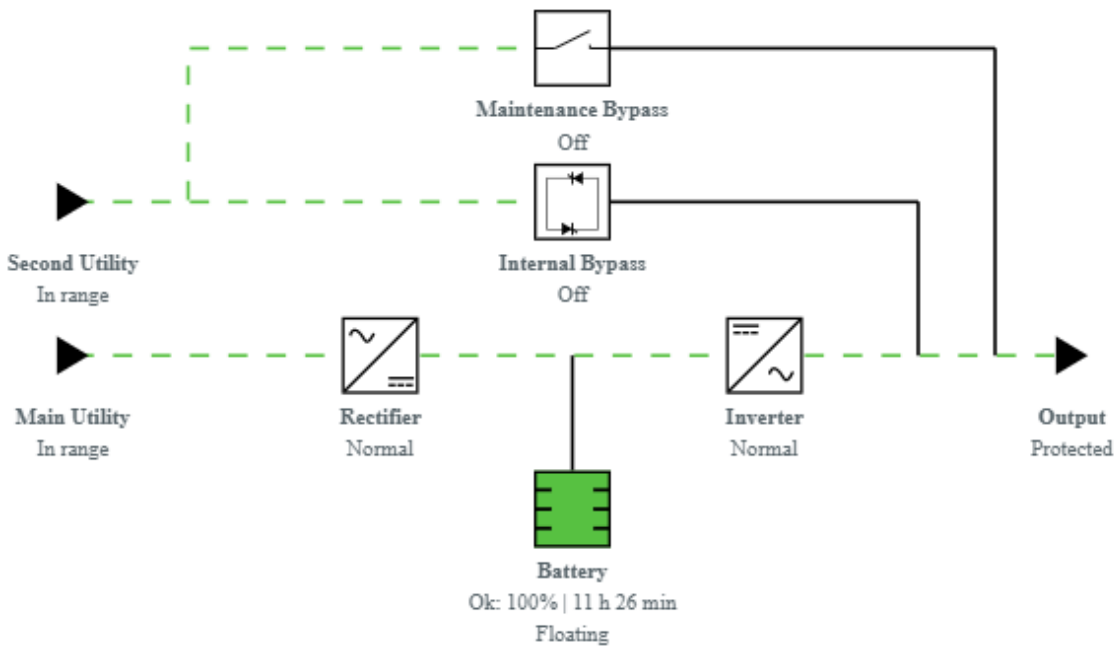

3.2.2.2 Bypass mode

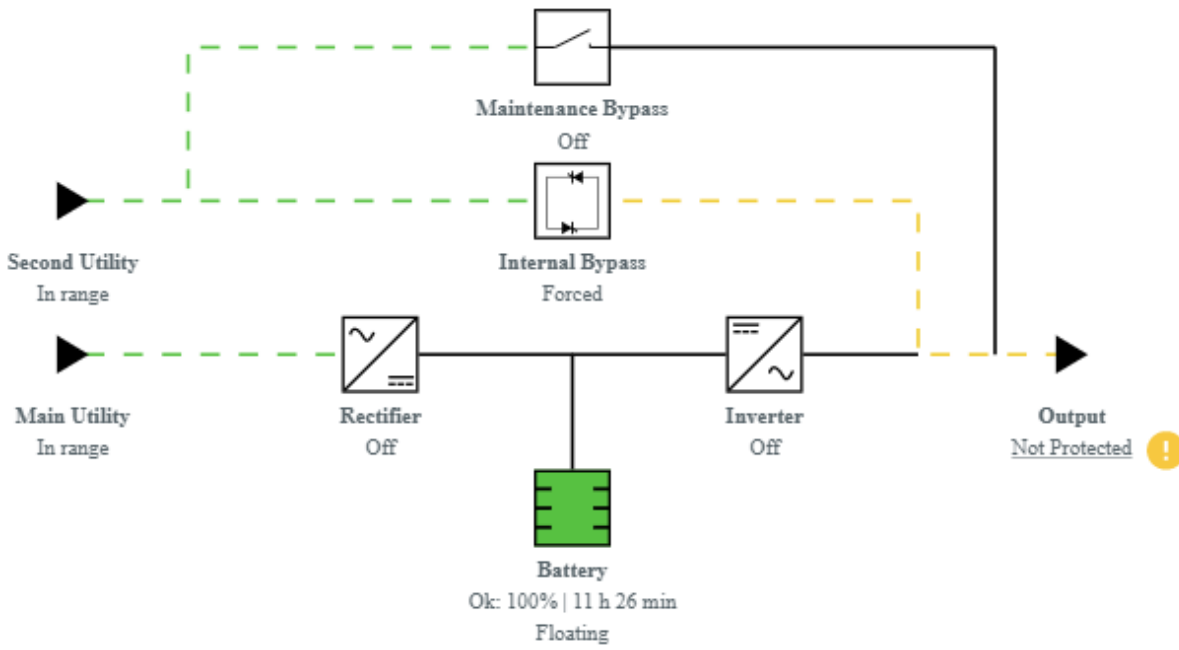

3.2.2.2.3 Battery mode

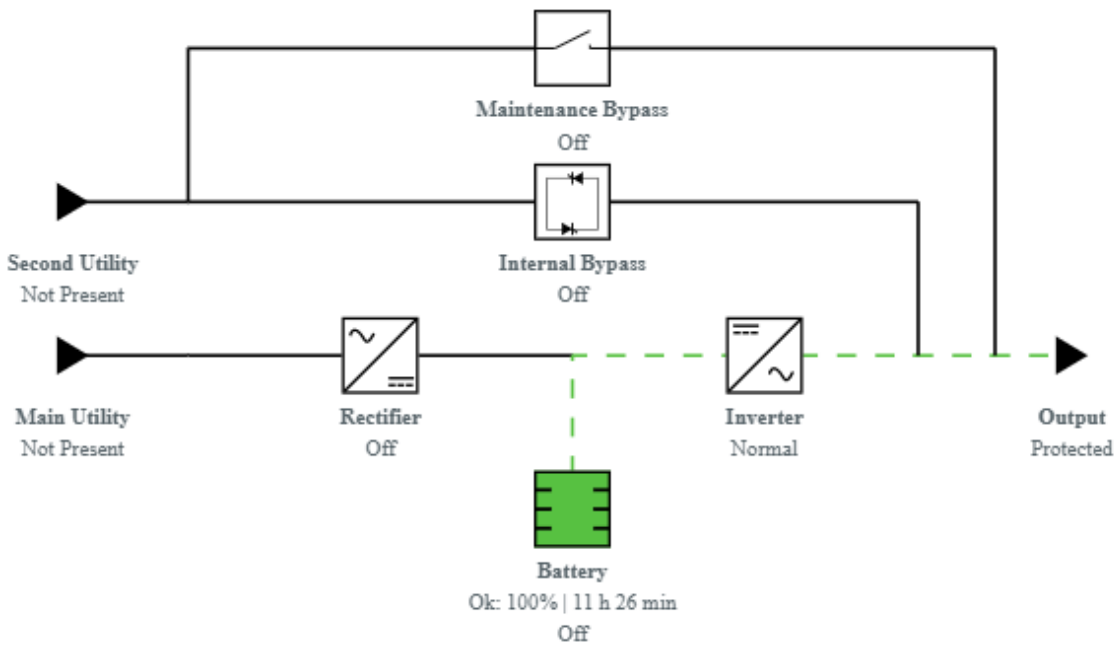

3.2.2.2.4 HE mode / ESS mode

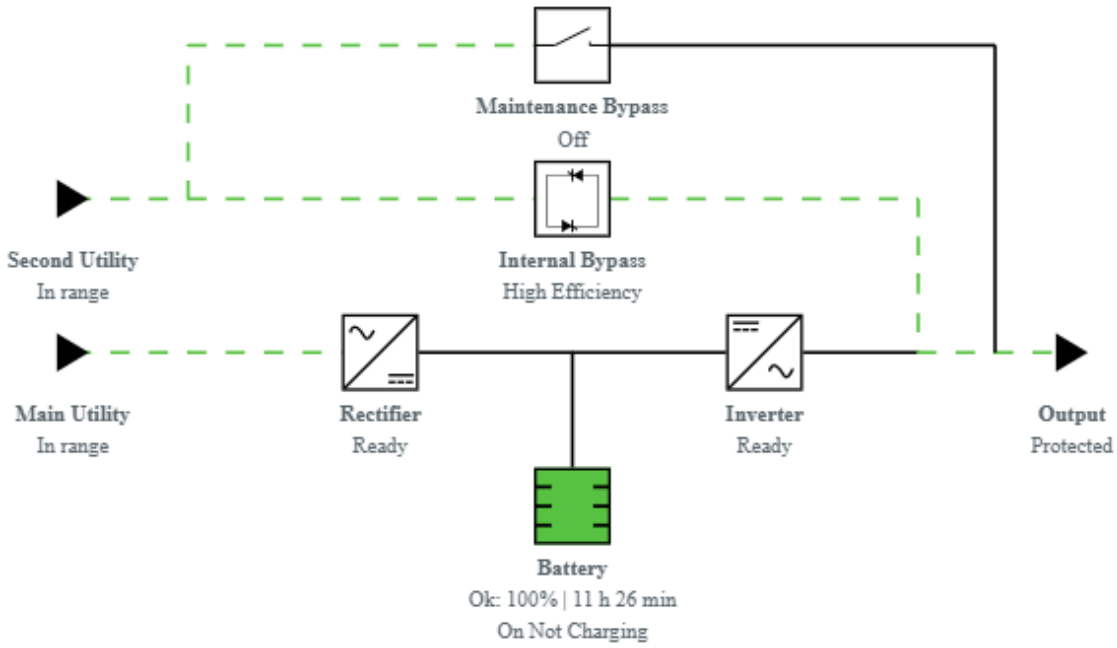

3.2.2.2.5 Maintenance bypass mode

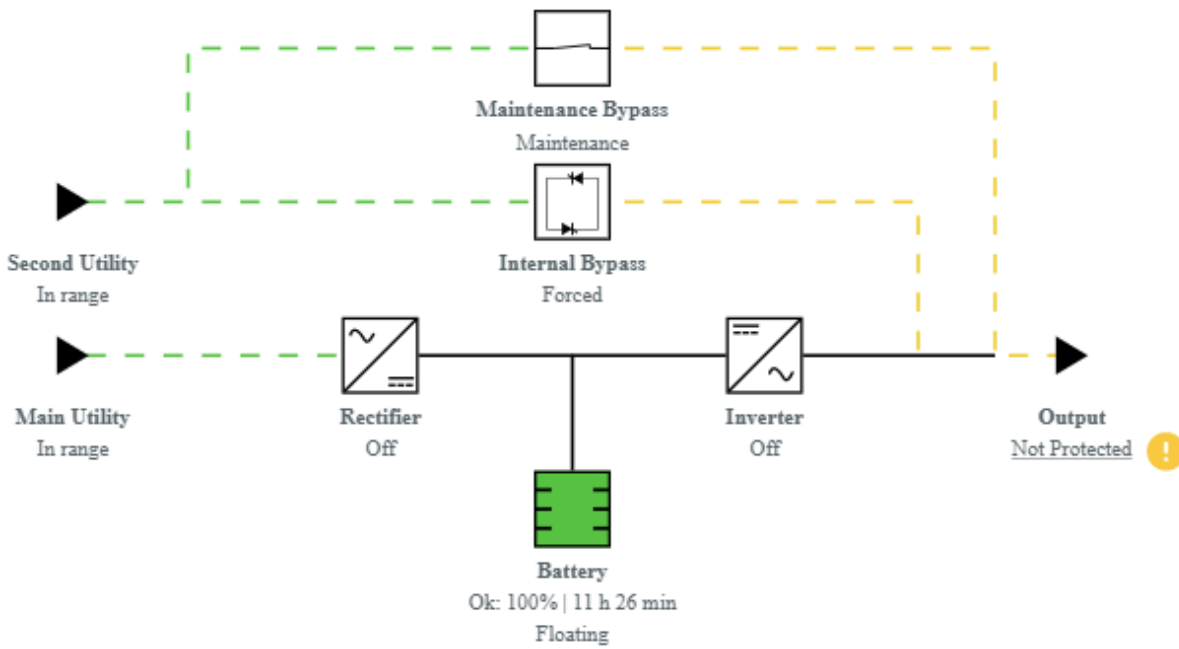

3.2.3 Access rights per profiles

	Administrator	Operator	Viewer
Home	✓	✓	✓

3.2.3.1 For other access rights



For other access rights, see the [Information>>>Access rights per profiles](#) section.

3.3 Meters



Gauge color code:

- Green: Value inside thresholds.
- Orange/Red: Value outside thresholds.
- Blue: No thresholds provided by the device.

3.3.1 Main utility input

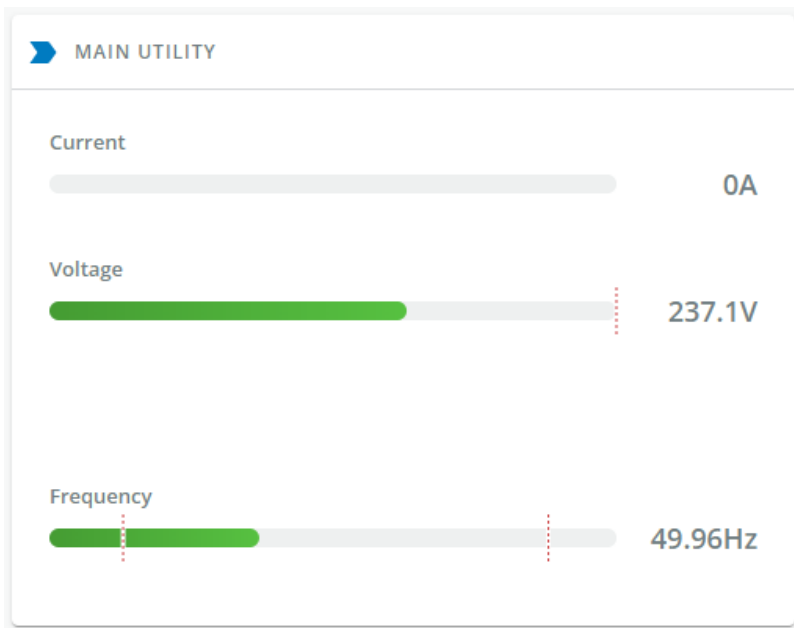

Displays the product main utility measures.

- Current (A)
- Voltage (V)
- Frequency (Hz)

3.3.2 Second utility input (if available)

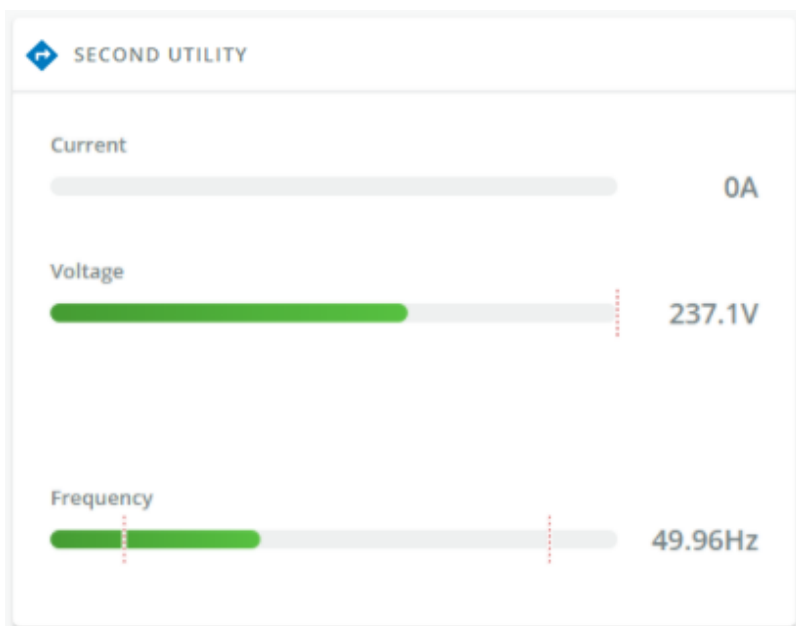

If presents, displays the product second utility measures.

- Current (A)
- Voltage (V)
- Frequency (Hz)

3.3.3 Output

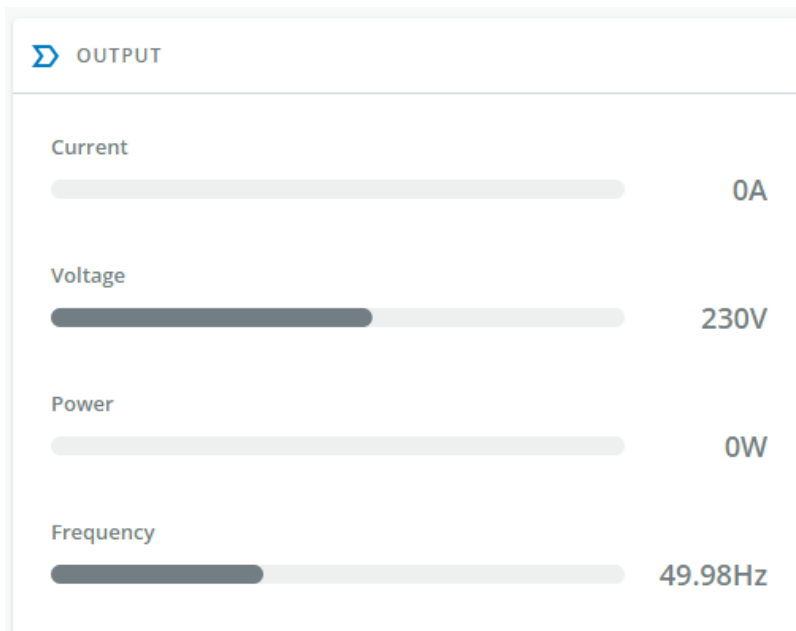

- Voltage (V)
- Power (W)
- Frequency (Hz)

3.3.4 Battery status

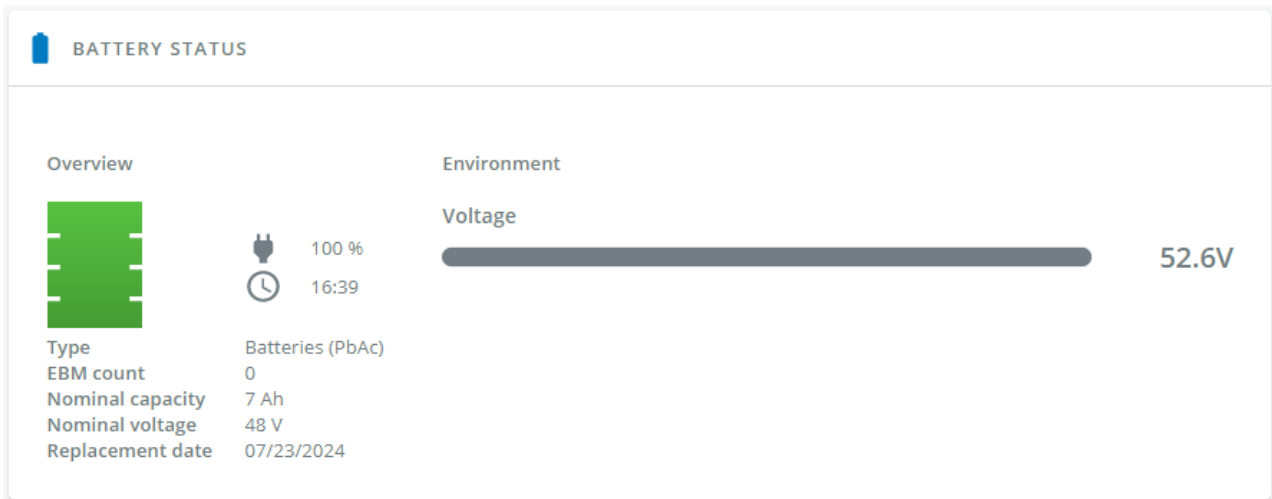

Battery status section is an overview of the battery information.



The information displayed depends on the device.

3.3.4.1 Overview/Environment

- Capacity remaining
- Runtime
- Type
- EBM count – Provides the number of External Battery Modules connected if any
- Nominal capacity
- Nominal voltage
- State– Discharging/Charging/Floating/Resting
- Recommended replacement date
- State of health
- Voltage
- Current
- Min cell voltage
- Max cell voltage
- Number of cycles
- Min temperature
- Max temperature
- BMS state

3.3.5 Battery health

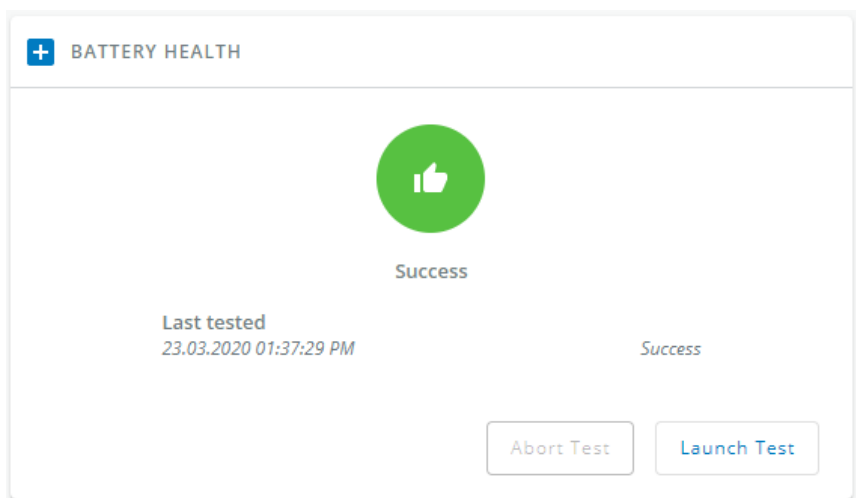

Battery health section provides status of the battery and allow to launch a battery test.

The status reflects the last completed battery test result, as well as its critical status (color) and completion time.

- Pass
- Warning
- Fail
- Unknown

3.3.5.1 Commands

Launch test button is disabled if a battery test is already in progress or scheduled.

The **Abort test** button is enabled only when a test is in progress or scheduled.

3.3.5.2 Pending action

The pending action reflects the battery test status.

- None
- Scheduled
- In progress
- Aborted
- Done

3.3.6 Logs

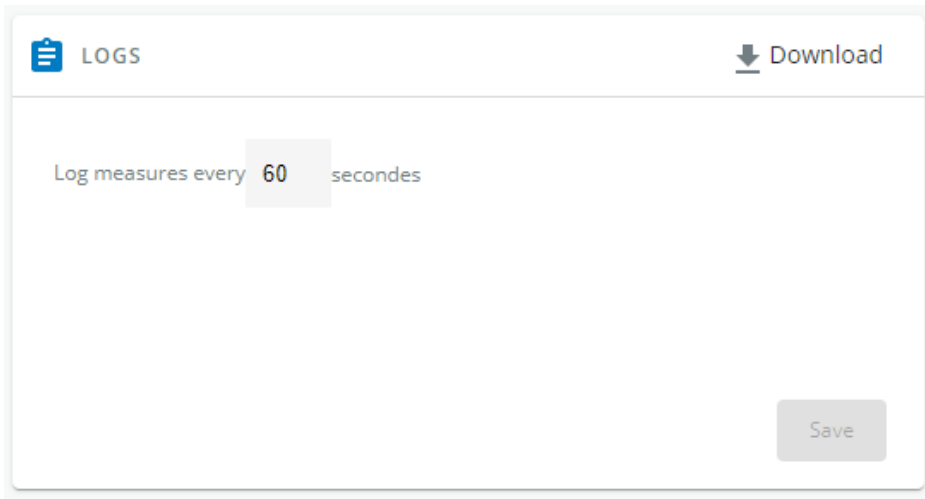

This log configuration allows to define the log acquisition frequency of the Device measures only.



The sensors measures logs acquisition is not settable and done every minutes. Sensors measures logs are accessible in Environment menu.

3.3.6.1 Download

Press the  Download icon on the top right to download the Device log file.

If available, possible measures are listed below:

- Time (UTC)
- Input Voltage (V)
- Input Frequency (Hz)
- Bypass Voltage (V)
- Bypass Frequency (Hz)
- Output Voltage (V)
- Output Frequency (Hz)
- Output Current (A)
- Output Apparent Power (VA)
- Output Active Power (W)
- Output Power Factor
- Output Percent Load (%)
- Battery Voltage (V)
- Battery Capacity (%)
- Battery Remaining Time (s)

3.3.7 Default settings and possible parameters - Meters

	Default setting	Possible parameters
Meters/Logs	Log measures every — 60s	Log measures every — 3600s maximum

3.3.7.1 For other settings



For other settings, see the [Information>>>Default settings parameters](#) section.

3.3.8 Access rights per profiles

	Administrator	Operator	Viewer
Meters	✓	✓	✓
Battery health: Launch test/Abort	✓	✓	✗
Logs configuration	✓	✓	✗

3.3.8.1 For other access rights



For other access rights, see the [Information>>>Access rights per profiles](#) section.

3.3.9 Save and Restore

	SRR section	Settings	Possible values
Logs	measure	periodicity	[time in seconds]

3.3.9.1 Additional information



For details on Save and Restore, see the [Save and Restore](#) section.

3.4 Controls

3.4.1 Entire UPS

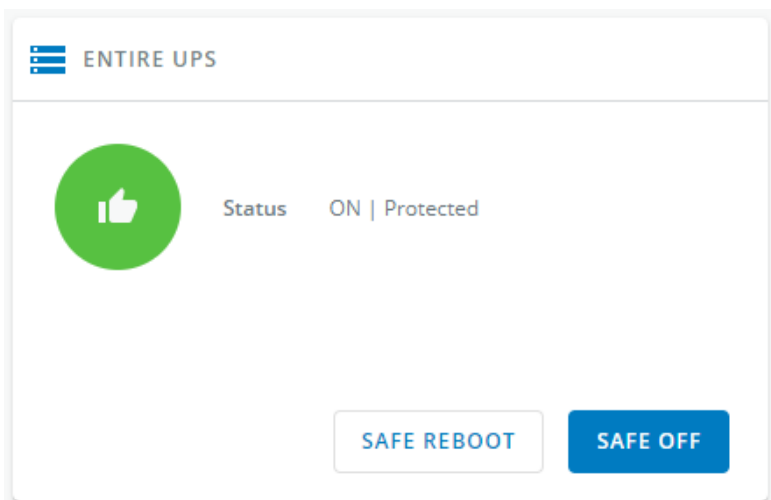

Controls are displayed for the entire UPS, and not for specific outlet options.

The table in this section displays UPS status, the associated commands (on/off), and the pending action.

3.4.1.1 Status

Reflects the current mode of the UPS. The following is a list of potential table values that are displayed based on the UPS topology.

- On — Protected/Not protected
- Off — Not powered/Not protected

3.4.1.2 Commands

A set of commands are available and activated when one of the following buttons is pressed. A confirmation window appears.

- **Safe OFF**

This will shut off the load. Protected applications will be safely powered down.

This control is available only if the status is not OFF and if there are no active commands running.

- **Safe reboot**

This will shut off and then switch ON the load. Protected applications will be safely powered down.

This control is available only if the status is not OFF and if there are no active commands running.

- **Switch ON**

This will switch ON the load or turn ON the online UPS.

This control is available when the status is OFF, if there are no active commands running and if the Online UPS is on bypass.

3.4.1.3 Pending action

Displays the delay before shutdown and delays before startup.

3.4.2 Outlets - Group 1/ Group 2

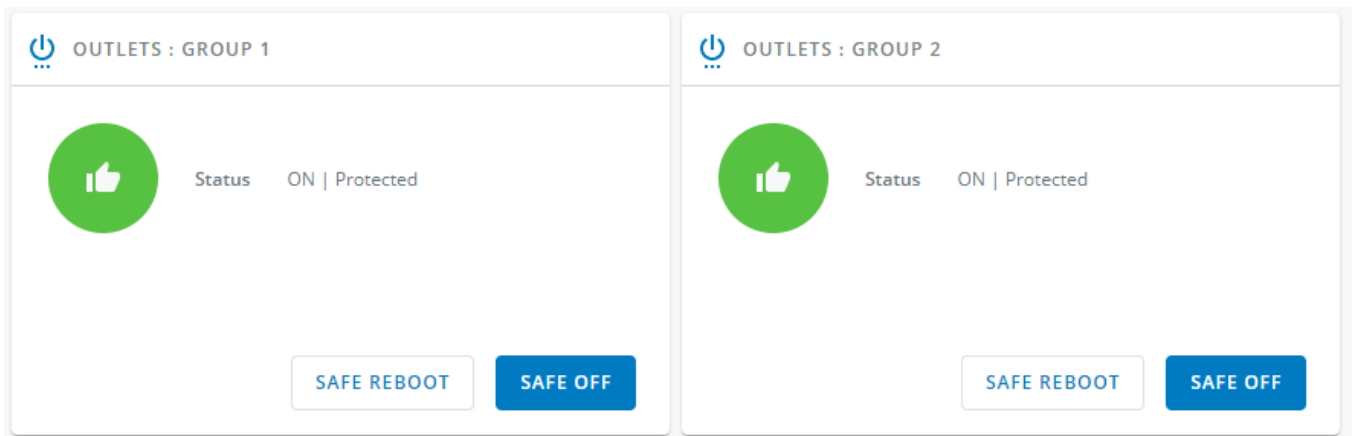

Load segmentations allow, battery runtime to remain on essential equipment and automatically power down non-priority equipment during an extended power outage.

This feature is also used for remote reboot and the sequential start of servers to restrict inrush currents.

3.4.2.1 Status

It reflects the current outlet status.

- On — Protected/Not protected
- Off — Not powered

3.4.2.2 Commands

A set of commands are available and activated when one of the following buttons is pressed. A confirmation window appears.

- **Safe OFF**

This will shut off the load connected to the associated load segment. Protected applications are safely powered down.

This control is available only if the status is not OFF and if there are no active commands running.

- **Safe reboot**

This will power down and then switch ON the load connected to the associated load segment. Protected applications are safely powered down.

This control is available only if the status is not OFF and if there are no active commands running.

- **Switch ON**

This will switch ON the load connected to the associated load segment.

This control is available when status is OFF and if there are no active commands running.

3.4.2.3 Pending action

Displays the delay before shutdown and delay before startup.

3.4.3 Scheduled shutdown

Use Scheduled shutdowns to turn off either the UPS or individual load segments at a specific day and time.

This feature is used for saving energy by turning off equipment outside of office hours or to enhance cybersecurity by powering down network equipment.

If server shutdown scenarios are defined for any of the connected servers or appliances, they will be triggered before the corresponding outlets are turned off as configured in shutdown settings.

3.4.3.1 Scheduled shutdown table

SCHEDULED SHUTDOWN						
+ New 🗑 Delete						
		Recurrence ↑	Load segment	Shutdown time	Restart time	Status
<input type="checkbox"/>		Every day	Primary	02/18/2021 20:00:00	02/19/2021 06:00:00	✔ Active

With current: [Agent shutdown sequencing](#) the shutdown sequence will last:

Primary: 220s
Group 1: 40s
Group 2: 70s

The table displays the scheduled shutdowns and includes the following details:

- **Recurrence** – Once/Every day/Every week
- **Load segment** – Primary/Group 1/Group 2
- **Shutdown time** – Date/Time
- **Restart time** – Date/Time
- **Status** – Active/Inactive

3.4.3.2 Actions

3.4.3.2.1 New

Press the **New** button to create a scheduled shutdown.

3.4.3.2.2 Delete

Select a schedule shutdown and press the **Delete** button to delete the scheduled shutdown.

3.4.3.2.3 Edit

Press the pen icon to edit schedule shutdown and to access the settings: 

3.4.3.3 Access rights per profiles

	Administrator	Operator	Viewer
Protection/Scheduled shutdowns	✔	✔	✘

3.4.3.3.1 For other access rights

 For other access rights, see the [Information>>>Access rights per profiles](#) section.

3.4.3.4 Save and Restore

	SRR section	Settings	Possible values
Scheduled shutdown	schedule	enabled	true/false
		scheduler	1: Primary 2: Group 1 3: Group 2
		recurrence	0: once 1: every day 2: every week
		shutdownTimeStamp	[timestamp (unix)]
		restartTimeStamp	[timestamp (unix)]

3.4.3.4.1 Additional information

 For details on Save and Restore, see the [Save and Restore](#) section.

3.4.3.5 Troubleshooting

Action not allowed in Control/Schedule/Power outage policy

Symptom

Below message is displayed when you access the Control, Schedule or Power outage policy page.

This action is not allowed by the UPS.

To enable it, please refer to the user manual of the UPS and its instructions on how to configure the UPS settings and allow remote commands.

Possible Cause

- 1- Remote commands are not allowed due to the UPS configuration (see the action below)
- 2- The UPS does not support remote commands.

Action

Refer to the UPS user manual and its instruction on how to configure the UPS settings and allow remote commands.

Example: UPS menu Settings>>>ON/OFF settings>>>Remote command>>>Enable.

3.4.3.5.1 For other issues



For details on other issues, see the [Troubleshooting](#) section.

3.5 Protection

3.5.1 Agents list

3.5.1.1 Pairing with shutdown agents



For details on pairing instructions, follow the link [pairing instructions](#) in the tile or see the [Servicing the Network Management Module>>>Pairing agent to the Network Module](#) section.

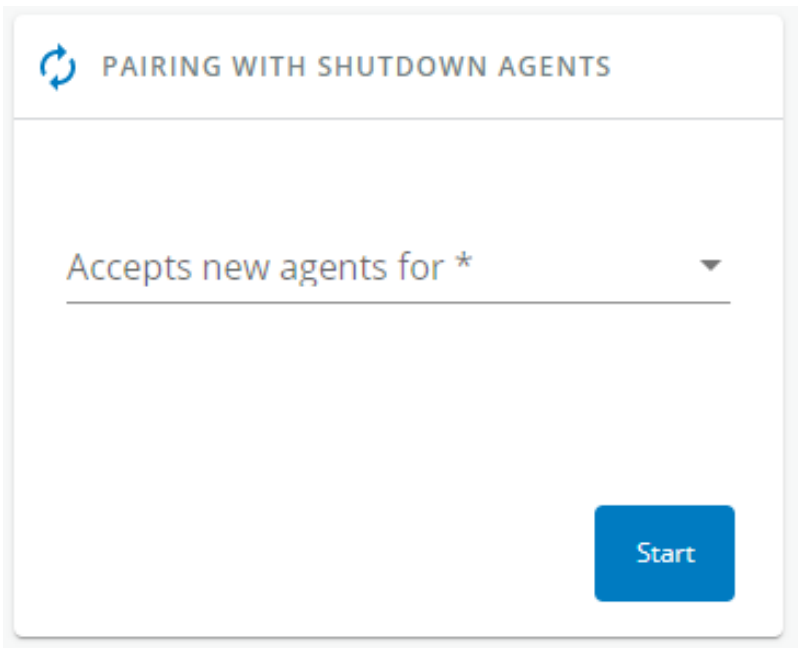

Authentication and encryption of connections between the UPS network module and shutdown agents is based on matching certificates. Automated pairing of shutdown agents and UPS network modules is recommended in case the installation is done manually in a secure and trusted network, and when certificates cannot be created in other ways.

During the selected timeframe, new agent connections to the Network Module are automatically trusted and accepted.

After automatic acceptance, make sure that all listed agents belong to your infrastructure. If not, access may be revoked using the **Delete** button.

For maximum security, Eaton recommends following one of the two methods on the **certificate settings** page:

- Import client certificates manually.
- Generate trusted certificate for both clients and Network Module using your own PKI.

3.5.1.1.1 Actions

a Start

Starts the pairing window for the selected timeframe or until it is stopped.

Time countdown is displayed.

b Stop

Stops the pairing window.

3.5.1.2 Agents list table

AGENTS LIST : (2)							
<input type="button" value="Delete"/>							
Name	Address	Version	Power source (Powering strategy)	Delay (s)	OS shutdown duration (s)	Status	Communication
<input type="checkbox"/> IPP: 192.168.1.100	192.168.1.100	1.0.0	Primary (Load shedding)	60	180	✔ In service Protected	Connected Since 10/10/2023 10:00:00
<input type="checkbox"/> IPP: 192.168.1.101	192.168.1.101	1.0.0	Primary (Load shedding)	0	120	✔ In service Protected	Connected Since 10/10/2023 10:00:00

The table displays the IPP agent list that is connected to the Network Module and includes the following details:

- Name
- Address
- Version of the Agent
- Power source (Powering strategy)
- Delay (in seconds)
- OS shutdown duration (in seconds)
- Status
 - In service | Protected
 - In service | Not protected
 - Stopping | Protected
 - Stopped | Protected
- Communication
 - Connected | yyyy/mm/dd hh:mm:ss
 - Lost | yyyy/mm/dd hh:mm:ss

3.5.1.3 Actions

3.5.1.3.1 Delete



When the agent is connected, the Delete function will not work correctly because the agent will keep on trying to re-connect.
So connect to the software, remove the Network module from the Software nodes list (in the nodes list, right click on the Network module and click **remove nodes**).

When communication with the agent is lost, agent can be deleted by using the **Delete** button.

Select an agent and press the **Delete** button to delete the agent.

3.5.1.4 Access rights per profiles

	Administrator	Operator	Viewer
Protection/Agent list	✔	✔	✘

3.5.1.4.1 For other access rights



For other access rights, see the [Information>>>Access rights per profiles](#) section.

3.5.1.5 Troubleshooting

Card wrong timestamp leads to "Full acquisition has failed" error message on Software

Symptoms:

IPP/IPM shows the error message "The full data acquisition has failed" even if the credentials are correct.

Possible cause:

The Network module timestamp is not correct.
Probably the MQTT certificate is not valid at Network module date.

Action:

Set the right date, time and timezone. If possible, use a NTP server, refer to [Contextual help>>>Settings>>>General>>>System details>>>Time & date settings](#) section.

Software is not able to communicate with the Network module

Symptoms

- In the Network Module, in [Contextual help>>>Protection>>>Agent list>>>Agent list table](#) , agent is showing "**Lost**" as a status.
- In the Network Module, in [Contextual help>>>Settings>>>Certificate>>>Trusted remote certificates](#) , the status of the Protected applications (MQTT) is showing "**Not valid yet**".
- IPP/IPM shows "The authentication has failed", "The notifications reception encountered error".

Possible cause

The IPP/IPM certificate is not yet valid for the Network Module.

Certificates of IPP/IPM and the Network Module are not matching so that authentication and encryption of connections between the Network Module and the shutdown agents is not working.

Setup

IPP/IPM is started.

Network module is connected to the UPS and to the network.

Action #1

Check if the IPP/IPM certificate validity for the Network Module.

STEP 1: Connect to the Network Module

- On a network computer, launch a supported web browser. The browser window appears.
- In the Address/Location field, enter: <https://xxx.xxx.xxx.xxx/> where xxx.xxx.xxx.xxx is the static IP address of the Network Module.
- The log in screen appears.
- Enter the user name in the User Name field.
- Enter the password in the Password field.
- Click **Login**. The Network Module web interface appears.

STEP 2: Navigate to **Settings/Certificates** page

STEP 3: In the **Trusted remote certificates** section, check the status of the **Protected applications (MQTT)**.

If it is "**Valid**" go to Action#2 STEP 2, if it is "**Not yet valid**", time of the need to be synchronized with IPP/IPM .

STEP 4: Synchronize the time of the Network Module with IPP/IPM and check that the status of the **Protected applications (MQTT)** is now valid.

Communication will then recover, if not go to Action#2 STEP 2.

Action #2

Pair agent to the Network Module with automatic acceptance (recommended in case the installation is done in a secure and trusted network).



For manual pairing (maximum security), go to [Servicing the Network Management Module>>>Pairing agent to the Network Module](#) section and then go to STEP 2, item 1.

STEP 1: Connect to the Network Module.

- On a network computer, launch a supported web browser. The browser window appears.
- In the Address/Location field, enter: `https://xxx.xxx.xxx.xxx/` where `xxx.xxx.xxx.xxx` is the static IP address of the Network Module.
- The log in screen appears.
- Enter the user name in the User Name field.
- Enter the password in the Password field.
- Click **Login**. The Network Module web interface appears.

STEP 2: Navigate to **Protection/Agents list** page.

STEP 3: In the **Pairing with shutdown agents** section, select the time to accept new agents and press the **Start** button and **Continue**. During the selected timeframe, new agent connections to the Network Module are automatically trusted and accepted.

STEP 4: Action on the agent (IPP/IPM) while the time to accepts new agents is running on the Network Module

Remove the Network module certificate file(s) *.0 that is (are) located in the folder `Eaton\IntelligentPowerProtector\configs\tls`.

Client server is not restarting

Symptom

Utility power has been restored, the UPS and its load segments are powered on, but the Client server does not restart.

Possible Cause

The "Automatic Power ON" server setup setting might be disabled.

Action

In the server system BIOS, change the setting for Automatic Power ON to "Enabled".

3.5.1.5.1 For other issues



For details on other issues, see the [Troubleshooting](#) section.

3.5.2 Agent shutdown sequencing

3.5.2.1 Agent shutdown sequence timing

Agent shutdown sequencing

See [Scheduled shutdown](#) or [Shutdown on power outage](#) to configure criteria to execute the shutdown sequence.

PRIMARY

Shutdown time: **250s** Immediate shutdown time: **190s**

Name	Delay (s)	OS shutdown duration (s)
Local		60
Agent#1	60	180
Agent#2	0	120

GROUP 1

Shutdown time: **40s** Immediate shutdown time: **40s**

Name	Delay (s)	OS shutdown duration (s)
Local		30

Name	Delay (s)	OS shutdown duration (s)
Local		60

All agents that are connected to the Network Module are displayed in tables by power sources.

- Primary
- Group 1
- Group 2

The 'local agent' setting is used for setting for example a minimum shutdown duration, or a power down delay for a load segment that has no registered shutdown agents.

One use case would be a load segment that powers network equipment that needs to stay on while servers and storage perform their orderly shutdown.



A shutdown time summary is calculated and displayed on the top of the table:

- Shutdown time: maximum time (Delay + OS shutdown duration + 10s) calculated among all the agents.
- Immediate shutdown time (OS shutdown duration + 10s) calculated among all the agents.

The tables include the following details:

- Name
- Delay (in seconds)
- OS shutdown duration (in seconds)

3.5.2.2 Actions

3.5.2.2.1 Set Delay

Select and directly change the setting in the table and then **Save**.

3.5.2.2.2 Set OS shutdown duration

Select and directly change the setting in the table and then **Save**.

3.5.2.3 Examples

Examples below show the impact of agent settings on the shutdown sequence for a shutdown or an immediate shutdown.

3.5.2.3.1 Example #1

Shutdown time: 220s		Immediate shutdown time: 130s	
Name	Delay (s)	OS shutdown duration (s)	
Local		120	
Agent#1	120	90	
Agent#2	90	60	

→ Shutdown time: 210s + 10s = 220s

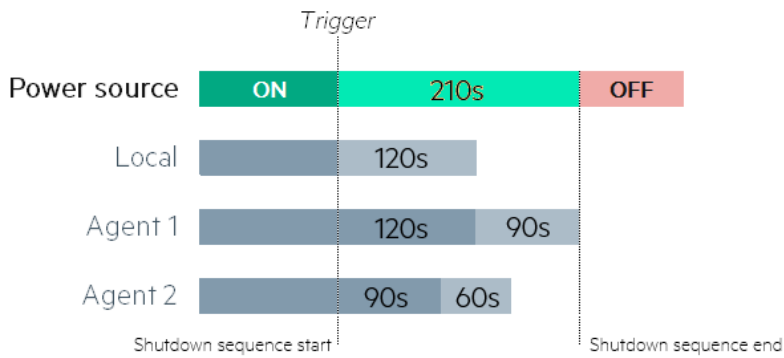

→ Immediate shutdown time: 120s + 10s = 130s

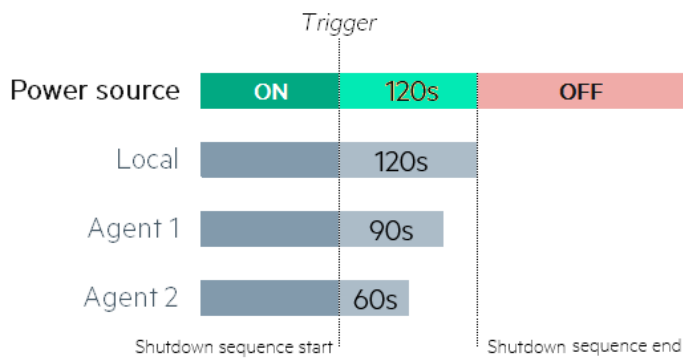

3.5.2.3.2 Example #2

Shutdown time: 190s		Immediate shutdown time: 190s	
Name	Delay (s)	OS shutdown duration (s)	
Local		0	
Agent#1	60	90	
Agent#2	0	180	

→ Shutdown time: 180s + 10s = 190s

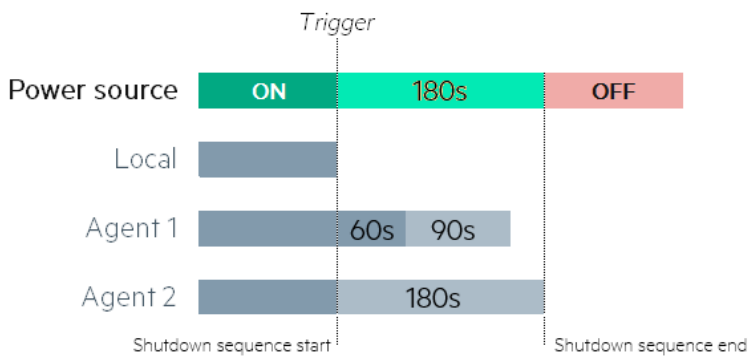

→ Immediate shutdown time: 180s + 10s = 190s

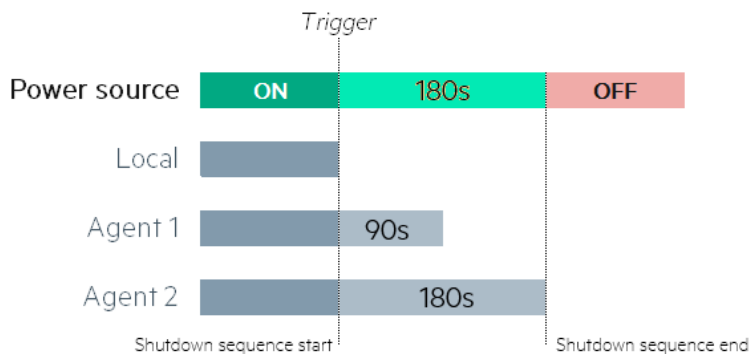

The trigger in the diagram is the moment when the shutdown sequence starts, and it is defined in the [Contextual help>>>Protection>>>Scheduled shutdown](#) or the [Contextual help>>>Protection>>>Shutdown on power outage](#) sections for each power source.

3.5.2.4 Access rights per profiles

	Administrator	Operator	Viewer
Protection/Agent settings	✓	✓	✗

3.5.2.4.1 For other access rights



For other access rights, see the [Information>>>Access rights per profiles](#) section.

3.5.3 Shutdown on power outage

These settings are in conjunction with the shutdown agents and control how the network module directs the shutdown of protected servers and appliances. It gives the possibility to prioritize and schedule shutdown actions so that the IT system is powered down in the correct order. For example, applications first, database servers next, and storage last. It is also possible to turn off some outlets to reduce power consumption and get longer battery runtime for the most important devices.



For examples on Powering down applications see the [Servicing the Network Management Module>>>Powering down/up applications examples](#) section.

3.5.3.1 Shutdown on power outage criteria

SHUTDOWN ON POWER OUTAGE CRITERIA

Primary
 Select the powering strategy *
 Custom

Execution criteria

Initiate the sequence when on battery for seconds

Initiate the sequence when the battery is under percent

End the sequence seconds
 before the end of the backup time

Group 1
 Select the powering strategy *
 Immediate OFF

Execution criteria

Initiate the sequence when on battery for seconds

Initiate the sequence when the battery is under percent

End the sequence seconds
 before the end of the backup time

Group 2
 Select the powering strategy *
 Maximize availability

Execution criteria

Initiate the sequence when on battery for seconds

Initiate the sequence when the battery is under percent

End the sequence seconds before the end of the backup time

With current **Agent shutdown sequencing** the shutdown sequence will last:

Primary: 250s
 Group 1: 40s
 Group 2: 70s

Shutdown criteria are set per power source (outlet groups) if they are present in the UPS.

 By default, shutdown criterias are set to Maximize availability.
Enable/Disable
 For each power source, the shutdown policy can be enabled or disabled with the toggle button.
 When disabled, the policy will be greyed out.

3.5.3.1.1 Shutdown criteria selection

The available criteria for shutdown are listed below:

a Maximize availability (default)

To end the shutdown sequence 30s before the end of backup time.

b Immediate OFF

To initiate the shutdown sequence when on battery for 10 seconds.

c Load shedding

To start the shutdown when on battery for the time set in (s) or when the battery capacity reaches the capacity in (%). When disabled, the condition is greyed out.

d Custom

Several conditions can be set to define shutdown criteria:

- To initiate the shutdown sequence when on battery for 10 seconds.
- To initiate the sequence when the battery reaches the set capacity in (%)
- To initiate or end the shutdown sequence after the set time in (s) before the end of backup time.

When there are several conditions to start the shutdown sequence, the shutdown sequence will start as soon as one of the condition is reached.

 When primary shuts OFF, both group1 and group 2 shut OFF immediately.
 So if Primary is set to Immediate OFF, groups policies should be restricted to Immediate OFF.

e Settings examples

All the following examples are using below agent's settings.

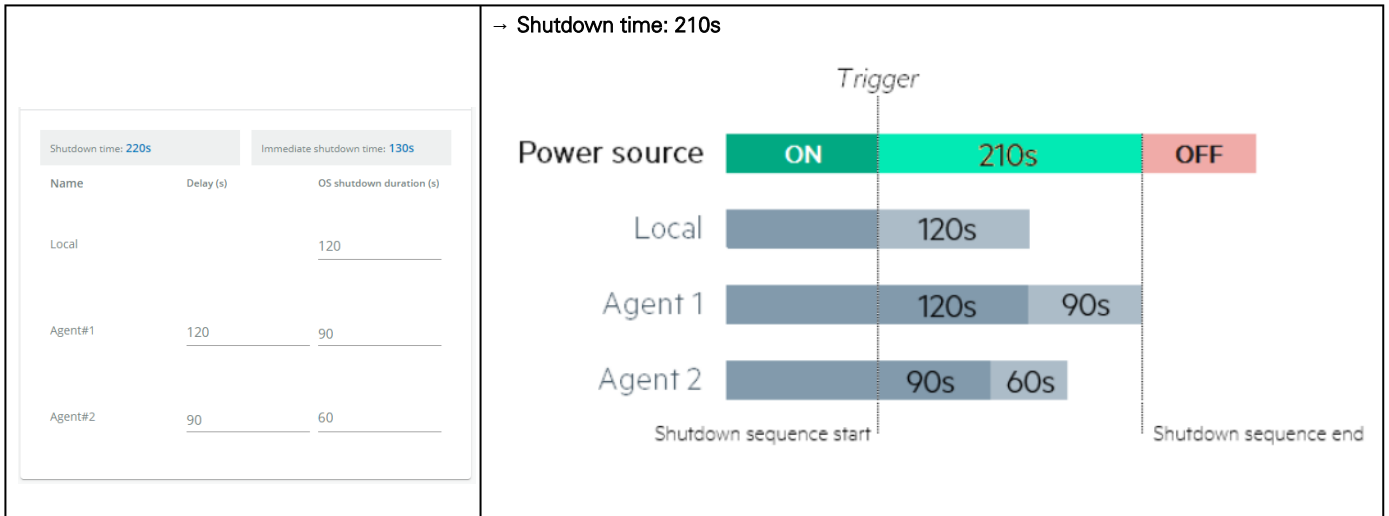

Example 1: Maximize availability

Select the powering strategy
Maximize availability

Execution criteria:

Initiate the sequence when on battery for seconds

Initiate the sequence when the battery is under percent

End the sequence seconds before the end of the backup time

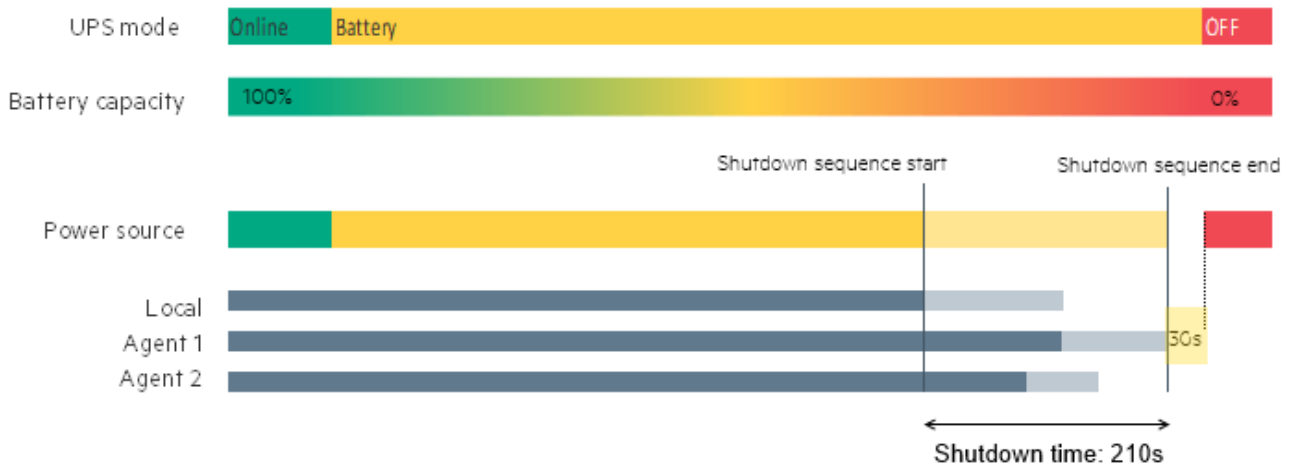

Example 2: Immediate OFF

Select the powering strategy
Immediate OFF

Execution criteria:

- Initiate the sequence when on battery for **10** seconds
- Initiate the sequence when the battery is under percent
- Initiate the sequence seconds before the end of the backup time

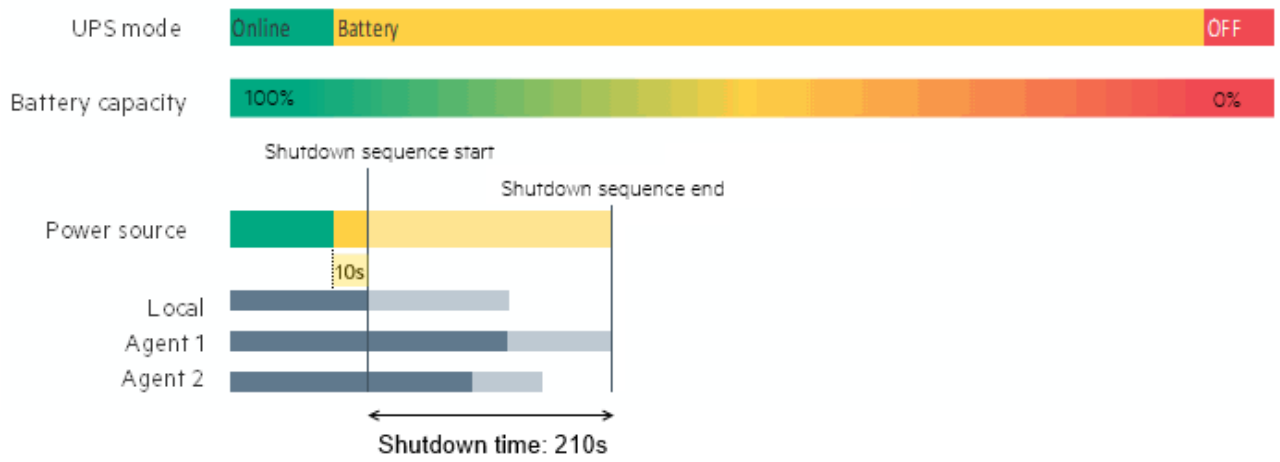

Example 3: Custom

Settings #1	<p>Select the powering strategy Custom</p> <hr/> <p>Execution criteria:</p> <ul style="list-style-type: none"> <input checked="" type="checkbox"/> Initiate the sequence when on battery for 900 seconds <input checked="" type="checkbox"/> Initiate the sequence when the battery is under 10 percent <input checked="" type="checkbox"/> Initiate the sequence 240 seconds before the end of the backup time
-------------	---



3.5.3.1.2 On low battery warning

On low battery warning:

- Launch an "immediate shutdown" on all load segments
 Immediate shutdown will cause all protected devices (agents) to shutdown simultaneously, delays set in the agent shutdown sequence timing have no effect.

With current [Agent shutdown sequencing](#) the immediate shutdown sequence will last:

Primary: 130s
 Group 1: 40s
 Group 2: 70s

In some cases, like a renewed power failure or failed battery, the capacity is much lower than anticipated. The UPS gives a Low battery warning when there is 2 - 3 minutes of estimated runtime left, depending on the UPS and its settings. This time is typically enough for shutting down a server but does not allow sophisticated sequential shutdown schemes.

The Low battery policy is intended for these cases.

3.5.3.1.3 When utility comes back

When utility comes back:

- Keep shutdown sequence running until the end and then restart (forced reboot)
- Automatically restart the UPS when battery capacity exceeds percent
 - Then Primary after seconds
 - Then Group 1 after seconds
 - Then Group 2 after seconds

Note: When utility comes back settings cannot be altered for three phase UPS units and will remain at their defaults.

These settings define the restart sequence when utility comes back. For example, this allows sequential startup of the IT system so that network and storage devices are connected to 'Primary' and start up immediately. After a delay database servers in Group1 are powered up, and then application and web servers in Group 2 are powered up. This startup would ensure that necessary services would be available for each layer when needed. A sequential startup will also help avoid a peak power draw in the beginning.

a Options

Keep shutdown sequence running until the end, and then restart (forced reboot).

Wait until UPS battery capacity exceeds a set percentage value in (%), and then automatically restart the UPS.

- Then restart Group 1 after a set time in (s).
- Then restart Group 2 after a set time in (s).

b Enable/Disable

Each option listed above can be enabled or disabled with check-boxes.

When disabled, the option will be greyed out.

3.5.3.2 Access rights per profiles

	Administrator	Operator	Viewer
Protection/Sequence	✔	✔	✘

3.5.3.2.1 For other access rights



For other access rights, see the [Information>>>Access rights per profiles](#) section.

3.5.3.3 Save and Restore

	SRR section	SRR sub section	Settings	Possible values
Shutdown on power outage	powerOutagePolicy/Settings	panicShutdownTriggers	onLowStateOfCharge	true/false

		restart	enabled	true/false	
	powerOutagePolicy/ suppliersSettings		id	1: Primary 2: Group 1 3: Group 2	
		settings	localShutdownDuration	[time in seconds]	
		shutdownTriggers/ powerOutage		enabled	true/false
				capacityLessThan	[percentage]
				afterBackupTime	[time in seconds]
				startShutdownBeforeEndOf Backup	[time in seconds]
				endShutdownBeforeEndOfB ackup	[time in seconds]

3.5.3.3.1 Additional information



For details on Save and Restore, see the [Save and Restore](#) section.

3.5.3.4 Troubleshooting

Action not allowed in Control/Schedule/Power outage policy

Symptom

Below message is displayed when you access the Control, Schedule or Power outage policy page.

This action is not allowed by the UPS.

To enable it, please refer to the user manual of the UPS and its instructions on how to configure the UPS settings and allow remote commands.

Possible Cause

- 1- Remote commands are not allowed due to the UPS configuration (see the action below)
- 2- The UPS does not support remote commands.

Action

Refer to the UPS user manual and its instruction on how to configure the UPS settings and allow remote commands.

Example: UPS menu Settings>>>ON/OFF settings>>>Remote command>>>Enable.

Client server is not restarting

Symptom

Utility power has been restored, the UPS and its load segments are powered on, but the Client server does not restart.

Possible Cause

The "Automatic Power ON" server setup setting might be disabled.

Action

In the server system BIOS, change the setting for Automatic Power ON to "Enabled".

3.5.3.4.1 For other issues



For details on other issues, see the [Troubleshooting](#) section.

3.6 Environment

3.6.1 Commissioning/Status

3.6.1.1 Sensors commissioning/Status table

The table displays the sensors commissioning information and includes the following details.

- **Name**
- **Location** – location-position-elevation
- **Temperature**
- **Humidity**
- **Dry contact #1** – Status and name
- **Dry contact #2** – Status and name
- **Communication** – Connected/Lost with dates

3.6.1.2 Actions

3.6.1.2.1 Download sensors measures

Press the **Download sensors measures** button to download the sensors log file: 

If available, possible measures are listed below:

- Temperature of <sensor_1> (in K, 1 decimal digit)
- Humidity of <sensor_1> (in %, 1 decimal digit)
- Temperature of <sensor_2>> (in K, 1 decimal digit)
- Humidity of <sensor_2> (in %, 1 decimal digit)
- Temperature of <sensor_3> (in K, 1 decimal digit)
- Humidity of <sensor_3> (in %RH, 1 decimal digit)



°C = K - 273.15
°F = K x 9/5 - 459.67

3.6.1.2.2 Discover

At first the table is empty, press the **Discover** button to launch the sensor discovery process.

If sensors are discovered, the table is populated accordingly

3.6.1.2.3 Delete

Select a sensor and press the **Delete** button to delete the sensor.



When a sensor is deleted, all the commissioning information are deleted.

3.6.1.2.4 Define offsets

Define offsets
✕

Temperature

EMPDT1H1C2 @1 *

28.9°C → 28.9°C

Humidity

EMPDT1H1C2 @1 *

20.8% → 20.8 %

Save

1. Select the sensors.
2. Press the **Define offset** button to adjust the temperature and humidity offsets of the selected sensors.
3. Extend the temperature or humidity section.
4. Set the offsets in the cell, temperatures and humidity will be updated accordingly.
5. Press the **Save** button when done.



Deactivated humidity or temperatures are not displayed and replaced by this icon:



3.6.1.2.5 Edit

Sensor commissioning
✕

Product	Eaton EMPDT1H1C2	Temperature <input checked="" type="checkbox"/>	
Part number	EMPDT1H1C2	Name *	EMPDT1H1C2 @1-T1
Serial number	GB13J28239	Humidity <input checked="" type="checkbox"/>	
Name *	EMPDT1H1C2 @1	Name *	EMPDT1H1C2 @1-H1
Location	Rack#1 Server room #2	Dry contact #1 <input checked="" type="checkbox"/>	
		Name *	EMPDT1H1C2 @1-C1
		Polarity *	Normally open
		Dry contact #2 <input checked="" type="checkbox"/>	
		Name *	EMPDT1H1C2 @1-C2
		Polarity *	Normally open

Press the pen logo to edit sensor communication information:

You will get access to the following information and settings:

- Product reference
- Part number
- Serial number
- Name
- Location
- Temperature and humidity – Active (Yes, No)
- Dry contacts – Active (Yes, No)/Name/Polarity (Normally open, Normally closed)

	The dry contact is close and this is normal because it is configured as normally close.
	The dry contact is open and this is normal because it is configured as normally open.
	The dry contact is open and this is not normal because it is configured as normally close.
	The dry contact is close and this is not normal because it is configured as normally open.

Press **Save** after modifications.



Deactivated dry contacts are not displayed and replaced by this icon:



3.6.1.3 Note:



If the UPS provides temperature compensated battery charging option, see the [Servicing the EMP>>>Using the EMP for temperature compensated battery charging](#) section.

3.6.1.4 Access rights per profiles

	Administrator	Operator	Viewer
Environment/Commissioning	✓	✓	✗
Environment/Status	✓	✓	✓

3.6.1.4.1 For other access rights



For other access rights, see the [Information>>>Access rights per profiles](#) section.

3.6.1.5 Troubleshooting

EMP detection fails at discovery stage

In the Network Module, in [Contextual help>>>Environment>>>Commissioning/Status](#) , EMPs are missing in the Sensor commissioning table.

Symptom #1

The EMPs green RJ45 LED (FROM DEVICE) is not ON.

Possible causes

The EMPs are not powered by the Network module.

Action #1-1

Launch again the discovery, if it is still not ok, go to Action #1-2.

Action #1-2

1- Check the EMPs connection and cables.

Refer to the sections [Servicing the EMP>>>Installing the EMP>>>Cabling the first EMP to the device](#) and [Servicing the EMP>>>Installing the EMP>>>Daisy chaining 3 EMPs](#) .

2- Disconnect and reconnect the USB to RS485 cable.

3- Launch the discovery, if it is still not ok, go to Action #1-3.

Action #1-3

- 1- Reboot the Network module.
- 2- Launch the discovery.

Symptom #2

The EMPs orange RJ45 LEDs are not blinking.

Possible causes

- C#1: the EMP address switches are all set to 0.
 C#2: the EMPs are daisy chained, the Modbus address is the same on the missing EMPs.

Action #2-1

- 1- Change the address of the EMPs to have different address and avoid all switches to 0.
 Refer to the section [Servicing the EMP>>>Defining EMPs address and termination>>>Manual addressing](#) .
- 2- Disconnect and reconnect the USB to RS485 cable. The address change is only taken into account after an EMP power-up.
- 3- Launch the discovery, if it is still not ok, go to Action #2-2.

Action #2-2

- 1- Reboot the Network module.
 Refer to the section [Contextual help>>>Maintenance>>>Services>>>Reboot](#) .
- 2- Launch the discovery.

3.6.1.5.1 For other issues

For details on other issues, see the [Troubleshooting](#) section.

3.6.2 Alarm configuration

Humidity, temperatures or dry contacts deactivated during commissioning are not displayed.

Gauge color code:

- Green: Value inside thresholds.
- Orange/Red: Value outside thresholds.
- Grey: No thresholds provided by the device.

3.6.2.1 Temperature

Name	Location	Enabled	Low critical	Low warning	High warning	High critical	Hysteresis	Visual update	Live reading
EMPDT1H1C2 @1-T1	Rack#1 Server room #2	<input type="checkbox"/>	0	10	70	80	1		28.9°C

[Save](#)

The table shows the following information and settings for each sensor:

- Name
- Location
- Enabled – yes/no
- Low critical threshold – xx°C or xx°F
- Low warning threshold – xx°C or xx°F
- High warning threshold – xx°C or xx°F
- High critical threshold – xx°C or xx°F
- Hysteresis – x°C or x°F
- Visual update
- Live reading (MIN-MAX shows the minimal and maximal temperature measured by the sensor)

3.6.2.1.1 Actions

a Set Enabled

Select and directly change the setting in the table and then **Save**.

When disabled, no alarm will be sent.

b Set alarm threshold

Enable the alarm first and then change the setting in the table and then **Save**.

When a warning threshold is reached, an alarm will be sent with a warning level.

When a critical threshold is reached, an alarm will be sent with a critical level.

c Set Hysteresis

Enable the alarm first and change the setting in the table and then **Save**.

The hysteresis is the difference between the value where the alarm turns ON from turning OFF and the value where it turns OFF from turning ON.

3.6.2.2 Humidity

Name	Location	Enabled	Low critical	Low warning	High warning	High critical	Hysteresis	Visual update	Live reading
EMPDT1H1C2 @1-H1	Rack#1 Server room #2	<input type="checkbox"/>	10	20	80	90	1		20.8%

[Save](#)

The table shows the following information and settings for each sensor:

- Name
- Location
- Enabled – yes/no
- Low critical threshold – xx%
- Low warning threshold – xx%
- High warning threshold – xx%
- High critical threshold – xx%
- Hysteresis – x%
- Visual update
- Live reading (MIN-MAX shows the minimal and maximal humidity measured by the sensor)

3.6.2.2.1 Actions

a Set Enabled

Select and directly change the setting in the table and then **Save**.

When disabled, no alarm will be sent.

b Set alarm threshold

Enable the alarm first and then change the setting in the table and then **Save**.

When a warning threshold is reached, an alarm will be sent with a warning level.

When a critical threshold is reached, an alarm will be sent with a critical level.

c Set Hysteresis

Enable the alarm first and then change the setting in the table and then **Save**.

The hysteresis is the difference between the value where the alarm turns ON from turning OFF and the value where it turns OFF from turning ON.

3.6.2.3 Dry contacts

Name	Location	Enabled	Alarm severity
EMPDT1H1C2 @1-C1	Rack#1 Server room #2	<input type="checkbox"/>	Info Warning Critical
EMPDT1H1C2 @1-C2	Rack#1 Server room #2	<input type="checkbox"/>	Info Warning Critical

Save

The table shows the following settings for each dry contact:

- Name
- Location
- Enabled – yes/no
- Alarm severity – Info/Warning/Critical

3.6.2.3.1 Actions

a Set Enabled



Enable the alarm first and then change the setting in the table and then **Save**.

When disabled, no alarm will be sent.

b Set alarm severity

Enable the alarm first and then change the setting in the table and then **Save**.

When the dry contacts is not in a normal position, an alarm will be sent at the selected level.

	The dry contact is open and this is not normal because it is configured as normally close.
	The dry contact is close and this is not normal because it is configured as normally open.



3.6.2.4 Default settings and possible parameters - Environment Alarm configuration

	Default setting	Possible parameters
Temperature	Enabled — No Low critical – 0°C/32°F Low warning – 10°C/50°F High warning – 70°C/158°F High critical – 80°C/176°F	Enabled — No/Yes low critical<low warning<high warning<high critical
Humidity	Enabled — No Low critical – 10% Low warning – 20% High warning – 80% High critical – 90%	Enabled — No/Yes 0%<low critical<low warning<high warning<high critical<100%
Dry contacts	Enabled — No Alarm severity – Warning	Enabled — No/Yes Alarm severity – Info/Warning/Critical

3.6.2.4.1 For other settings

For other settings, see the [Information>>>Default settings parameters](#) section.

3.6.2.5 Access rights per profiles

	Administrator	Operator	Viewer
Environment/Alarm configuration			

3.6.2.5.1 For other access rights



For other access rights, see the [Information>>>Access rights per profiles](#) section.

3.6.3 Information

Sensor information is an overview of all the sensors information connected to the Network Module.

EMPDT1H1C2 @1	
Name	Eaton EMPDT1H1C2
Vendor	Eaton
UUID	5c93d236-088d-5d77-bcd4-1afbd03af181
Part number	EMPDT1H1C2
Serial number	GB13J28239
Version	01.02.0009
Location	Rack#1 Server room #2

- Physical name
- Vendor
- Part number
- Firmware version
- UUID
- Serial number
- Location

3.6.3.1 Access rights per profiles

	Administrator	Operator	Viewer
Environment/Information	✓	✓	✓

3.6.3.1.1 For other access rights



For other access rights, see the [Information>>>Access rights per profiles](#) section.

3.7 Settings

3.7.1 General

3.7.1.1 System details

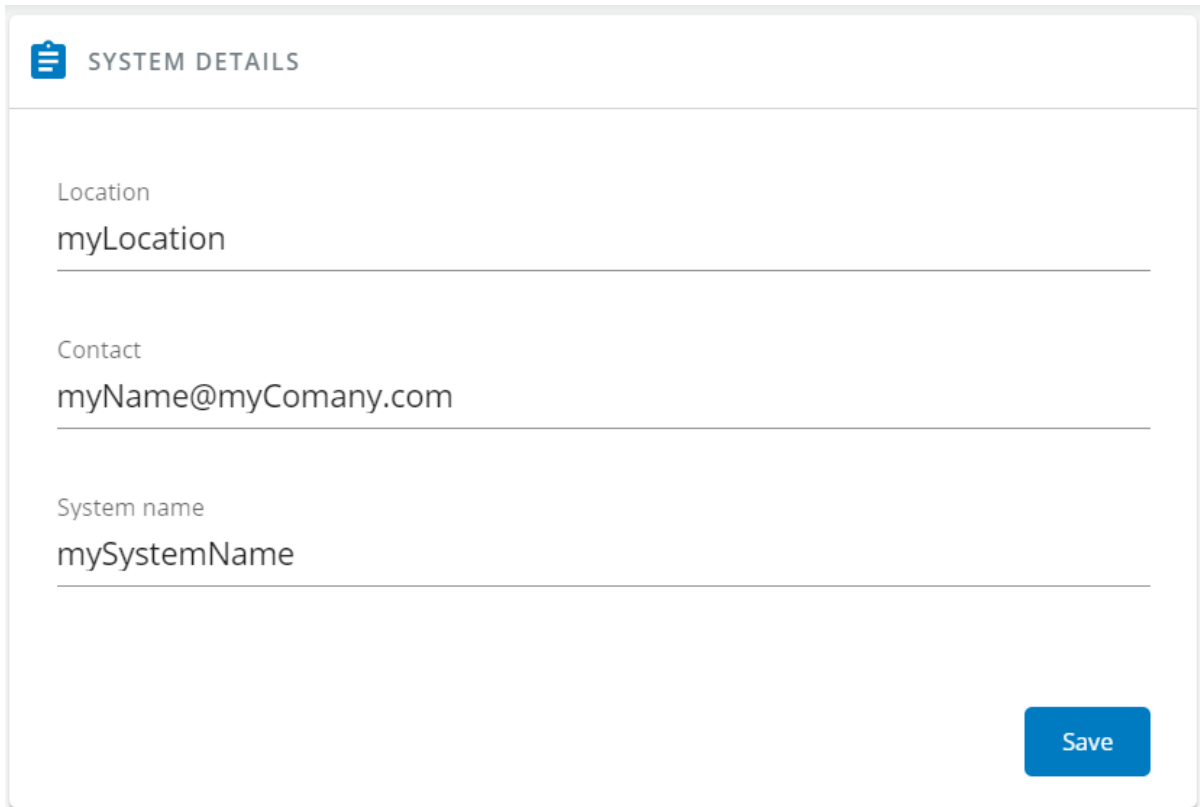

SYSTEM DETAILS

Location
myLocation

Contact
myName@myComany.com

System name
mySystemName

Save

3.7.1.1.1 Location

Text field that is used to provide the card location information.

Card system information is updated to show the defined location.

3.7.1.1.2 Contact

Text field that is used to provide the contact name information.

Card system information is updated to show the contact name.

3.7.1.1.3 System name

Text field that is used to provide the system name information.

Card system information is updated to show the system name.

3.7.1.2 Date & Time

DATE & TIME

Current date & time	12/07/2021 09:43:15
Time zone	Europe/Paris
Mode	Dynamic (NTP)
Status	✔ In service
NTP server 1	121.110.120.12 ✔ InUse

Edit

The current date and time appears at the top of the screen.

You can set the time either manually or automatically.

3.7.1.2.1 Manual mode: Manually entering the date and time

Date and time settings
×

Time zone
Europe/Paris

Mode
Manual ▼

Current date & time *
12/07/2021 09:43:15 🕒 📅

Save

1. Select the time zone for your geographic area.
2. Select the date and time.
3. Save the changes.

3.7.1.2.2 Dynamic (NTP): Synchronizing the date and time with an NTP server

Date and time settings ✕

Time zone
Europe/Paris

Mode
Dynamic (NTP) ▾

Get NTP server from DHCP

NTP Serveur 1

NTP Serveur 2

Save

1. Select the time zone for your geographic area.
2. Enter the IP address or host name of the NTP servers in the NTP server fields (up to 5 servers).
3. Save the changes.

3.7.1.2.3 Dynamic (NTP): Synchronizing the date and time from the DHCP server

Date and time settings ✕

Time zone
Europe/Paris

Mode
Dynamic (NTP) ▾

Get NTP server from DHCP

Save

1. Select the time zone for your geographic area.
2. Select Get NTP server from DHCP
3. Save the changes.



DST is managed based on the time zone.

3.7.1.3 Email notification settings



For examples on email sending configuration see the [Servicing the Network Management Module>>>Subscribing to a set of alarms for email notification](#) section.

EMAIL NOTIFICATION SETTINGS

Buttons: **+ New**, **Delete**

	Custom name ↑	Email	Notification updates	Status
<input type="checkbox"/>	Configuration #1	myName@myCompany.com	 Scheduled Alarms	Active
<input type="checkbox"/>	Configuration#2	myName@myCompany.com	 Alarms	Active

3.7.1.3.1 Email sending configuration table

The table shows all the email sending configuration and includes the following details:

- **Configuration name**
- **Email**
- **Notification updates** – Displays Events notification/Periodic report icons when active.
- **Status** – Active/Inactive/In delegation

3.7.1.3.2 Actions

a Add

Press the **New** button to create a new email sending configuration.

b Remove

Select an email sending configuration and press the **Delete** button to remove it.

c Edit

✕
Edit email notification settings

Custom name *
 Configuration #1

Email address *
 myName@myCompany.com

Status
 Active

Hide the IP address from the email body

Schedule report

Recurrence *
 Every day

Starting date *
 07/15/2020 13:53:00 🕒 📅

Subscribe	Attach measures	Attach logs	
<input type="checkbox"/>		<input type="checkbox"/>	Card events
<input type="checkbox"/>	<input type="checkbox"/>	<input type="checkbox"/>	Device events

Alarm notifications

All card events ▼

All device events ▼

[List of event codes](#)

Always notify events with code

Separate each code with a comma

Never notify events with code

Separate each code with a comma

Test
Save

Press the pen icon to edit email sending configuration:

You will get access to the following settings:

- **Custom name**
- **Email address**
- **Status** – Active/Inactive
- **Hide the IP address from the email body** – Disabled/Enabled
 This setting will be forced to Enabled if Enabled in the SMTP settings.
- **Schedule report** – Active/Recurrence/Starting/Topic selection – Card/Devices



Attachment will contains only logs that have occurred during the recurrence.

- **Alarm notifications** – Severity level/Attach logs/Exceptions on events notification

3.7.1.4 SMTP settings

 SMTP SETTINGS

Server IP / Hostname *

Port *

25

Default sender address *

Hide the IP address from the email body

Security ▾

Verify certificate authority

SMTP server authentication

Username *

Password

SMTP is an internet standard for electronic email transmission.

The following SMTP settings are configurable:

- **Server IP/Hostname** – Enter the host name or IP address of the SMTP server used to transfer email messages in the SMTP Server field.
- **Port**
- **Default sender address**
- **Hide the IP address from the email body** – Disabled/Enabled
If Enabled, it will force this setting to Enabled in the Email notification settings.
- **Security** – Verify certificate authority
- **SMTP server authentication** – Username/Password

Select the SMTP server authentication checkbox to require a user name and a password for SMTP authentication, enter the Username and the Password.

- Save and test server configuration

3.7.1.5 Default settings and possible parameters - General

	Default setting	Possible parameters
System details	Location — empty Contact — empty System name — empty Time & date settings — Manual (Time zone: Europe/Paris)	Location — 31 characters maximum Contact — 255 characters maximum System name — 255 characters maximum Time & date settings — Manual (Time zone: selection on map/Date) / Dynamic (NTP)
Email notification settings	No email	5 configurations maximum Custom name — 128 characters maximum Email address — 128 characters maximum Hide IP address from the email body — enable/disable Status — Active/Inactive <ul style="list-style-type: none"> • Alarm notifications <ul style="list-style-type: none"> Active — No/Yes All card events – Subscribe/Attach logs Critical alarm – Subscribe/Attach logs Warning alarm – Subscribe/Attach logs Info alarm – Subscribe/Attach logs All device events – Subscribe/Attach measures/Attach logs Critical alarm – Subscribe/Attach measures/Attach logs Warning alarm – Subscribe/Attach measures/Attach logs Info alarm – Subscribe/Attach measures/Attach logs <p>Always notify events with code Never notify events with code</p> <ul style="list-style-type: none"> • Schedule report <ul style="list-style-type: none"> Active — No/Yes Recurrence – Every day/Every week/Every month Starting – Date and time Card events – Subscribe/Attach logs Device events – Subscribe/Attach measures/Attach logs
SMTP settings	Server IP/Hostname — blank SMTP server authentication — disabled	Server IP/Hostname — 128 characters maximum SMTP server authentication — disable/enable (Username/Password — 128 characters maximum)

Port — 25	Port — x-xxx
Default sender address — device@networkcard.com	Sender address — 128 characters maximum
Hide IP address from the email body — disabled	Hide IP address from the email body — enable/disabled
Security — enabled	Secure SMTP connection — enable/disable
Verify certificate authority — disabled	Verify certificate authority — disable/enable
SMTP server authentication — disabled	

3.7.1.5.1 For other settings



For other settings, see the [Information>>>Default settings parameters](#) section.

3.7.1.6 Access rights per profiles

	Administrator	Operator	Viewer
General	✓	✗	✗

3.7.1.6.1 For other access rights



For other access rights, see the [Information>>>Access rights per profiles](#) section.

3.7.1.7 CLI commands

email-test

Description

mail-test sends test email to troubleshoot SMTP issues.

Help

```
Usage: email-test <command> ...
Test SMTP configuration.

Commands:
email-test -h, --help, Display help page

email-test -r, --recipient <recipient_address>
Send test email to the
  <recipient_address>      Email address of the recipient
```

time

Description

Command used to display or change time and date.

Help

For Viewer and Operator profiles:

```
time -h
Usage: time [OPTION]...
Display time and date.

-h, --help      display help page
-p, --print     display date and time in YYYYMMDDhhmmss format
```

For Administrator profile:

```
time -h
Usage: time [OPTION]...
Display time and date, change time and date.
-h, --help      display help page
-p, --print     display date and time in YYYYMMDDhhmmss format
-s, --set <mode>
  Mode values:
  - set date and time (format YYYYMMDDhhmmss)
    manual <date and time>
  - set preferred and alternate NTP servers
    ntpmanual <preferred server> <alternate server>
  - automatically set date and time
    ntpauto
Examples of usage:
-> Set date 2017-11-08 and time 22:00
   time --set manual 201711082200
-> Set preferred and alternate NTP servers
   time --set ntpmanual fr.pool.ntp.org de.pool.ntp.org
```

Examples of usage

```
-> Set date 2017-11-08 and time 22:00
   time --set manual 201711082200
-> Set preferred and alternate NTP servers
   time --set ntpmanual fr.pool.ntp.org de.pool.ntp.org
```

3.7.1.7.1 For other CLI commands



See the CLI commands in the [Information>>>CLI](#) section.

3.7.1.8 Save and Restore

	SRR section	SRR sub section	Settings	Sub Settings	Possible values
System details	card	identification	name		String: refer to default settings and possible parameters for constraints.
			contact		String: refer to default settings and possible parameters for constraints.
			location		String: refer to default settings and possible parameters for constraints.
Time and Date settings	date	ntp	enabled		true/false
			getServersFromDhcp		true/false
			servers	preferredServer	*
				alternateServer	*
timeZone		Examples: Europe/Paris Africa/Johannesburg America/New_York Asia/Shanghai			
Email	email	notifyOnEvents	enabled		true/false
			cardEvents	critical	
				subscribe	true/false
				attachEventsLog	true/false
			warning		
				subscribe	true/false
				attachEventsLog	true/false
info					
	subscribe	true/false			
	attachEventsLog	true/false			
devicesEvents	critical				
		subscribe	true/false		
		attachEventsLog	true/false		
		attachMeasuresLog	true/false		
		warning			
		subscribe	true/false		
		attachEventsLog	true/false		
attachMeasuresLog	true/false				
info					
	subscribe	true/false			

				attachEventsLog	true/false	
				attachMeasuresLog	true/false	
			exceptions	notifiedEvents	event codes separated by coma	
				noneNotifiedEvents	event codes separated by coma	
			periodicReport	enabled	true/false	
				periodicity	Every day/week/month	
				startTime	Unix timestamp	
			card	subscribe	true/false	
				attachEventsLog	true/false	
			devices	subscribe	true/false	
	attachEventsLog	true/false				
		attachMeasuresLog	true/false			
message		sender	String: refer to default settings and possible parameters for constraints.			
		subject	String: refer to default settings and possible parameters for constraints.			
		hidelpAddress	true/false			
SMTP	smtp	certificateData	ca	Certificate Authority of SMTP server		
			port	Number: refer to default settings and possible parameters for constraints.		
			enabled	true/false		
			server	IP address or hostname of SMTP server		
			requireAuth	true/false		
			user	Username for server authentication		
			password	plaintext	String: refer to default settings and possible parameters for constraints.	
				cyphered	-	
			fromAddress	email address format		
			ssl	1: None 2: STARTTLS 3: SSL		
verifyTlsCert	true/false					

3.7.1.8.1 Additional information



For details on Save and Restore, see the [Save and Restore](#) section.

3.7.2 Local users

3.7.2.1 Local users table

LOCAL USERS					
Global Settings New Delete					
		Username ↑	Email	Profile	Status
<input type="checkbox"/>		admin	myemail@mycompany.com	Administrator	Active

The table shows all the supported local user accounts and includes the following details:

- **Username**
- **Email**
- **Profile**
- **Status** – Status could take following values – Inactive/Locked/Password expired/Active



For the list of access rights per profile refer to the section [Full documentation>>>Information>>>Access rights per profiles](#).

3.7.2.1.1 Actions

a Add

Press the **New** button to create up to ten new users.

b Remove

Select a user and press the **Delete** button to remove it.

c Edit

Press the pen logo to edit user information:

You will get access to the following settings:

- Active
- Profile
- Username
- Full name
- Email
- Phone
- Organization – Notify by email about account modification/Password
- Generate randomly
- Enter manually
- Force password to be changed on next login

d Global settings

Global user settings

Password settings

Minimum length	8
<input checked="" type="checkbox"/> Minimum upper case	1
<input checked="" type="checkbox"/> Minimum lower case	1
<input checked="" type="checkbox"/> Minimum digit	1
<input checked="" type="checkbox"/> Special character	1

Password expiration

<input type="checkbox"/> Number of days until password expires	90
<input checked="" type="checkbox"/> Main administrator password never expires	

Lock account

<input type="checkbox"/> Lock account after	4	invalid tries
<input checked="" type="checkbox"/> Main administrator account never blocks		

Account timeout

No activity timeout	15	minutes
Session lease time	120	minutes

Save

Press **Save** after modifications.

Password settings

To set the password strength rules, apply the following restrictions:

- Minimum length
- Minimum upper case
- Minimum lower case
- Minimum digit
- Special character

Password expiration

To set the password expiration rules, apply the following restrictions:

- Number of days until password expires
- Main administrator password never expire

**Main administrator password never expires**

1. If this feature is disabled, the administrator account can be locked after the password expiration.
2. If Enabled, the administrator password never expires, make sure it is changed regularly.

Lock account

- Lock account after a number of invalid tries
- Main administrator account will never block

**Main administrator account will never block**

1. If this feature is disabled, the administrator account can be locked after the number of failed connections defined.
2. If Enabled, the security level of the administrator account is reduced because unlimited password entry attempts are allowed.

Account timeout

To set the session expiration rules, apply the following restrictions:

- No activity timeout (in minutes).
If there is no activity, session expires after the specified amount of time.
- Session lease time (in minutes).
If there is activity, session still expires after the specified amount of time.

3.7.2.2 Default settings and possible parameters - Global user settings and Local users

	Default setting	Possible parameters
Password settings	Minimum length — enabled (8) Minimum upper case — enabled (1) Minimum lower case — enabled (1) Minimum digit — enabled (1) Special character — enabled (1)	Minimum length — enable (6-32)/disable Minimum upper case — enable (0-32)/disable Minimum lower case — enable (0-32)/disable Minimum digit — enable (0-32)/disable Special character — enable (0-32)/disable
Password expiration	Number of days until password expires — disabled Main administrator password never expires — disabled	Number of days until password expires — disable/enable (1-99999) Main administrator password never expires — disable/enable
Lock account	Lock account after xx invalid tries — disabled Main administrator account never blocks — disabled	Lock account after xx invalid tries — disable/enable (1-99) Main administrator account never blocks — disable/enable
Account timeout	No activity timeout — 15 minutes Session lease time — 120 minutes	No activity timeout — 1-60 minutes Session lease time — 60-720 minutes
Local users	1 user only: <ul style="list-style-type: none"> • Active — Yes • Profile — Administrator • Username — admin • Full Name — blank • Email — blank • Phone — blank • Organization — blank 	10 users maximum: <ul style="list-style-type: none"> • Active — Yes/No • Profile — Administrator/Operator/Viewer • Username — 255 characters maximum • Full Name — 128 characters maximum • Email — 128 characters maximum • Phone — 64 characters maximum • Organization — 128 characters maximum

3.7.2.2.1 For other settings



For other settings, see the [Information>>>Default settings parameters](#) section.

3.7.2.3 Access rights per profiles

	Administrator	Operator	Viewer
Local users	✓	✗	✗

3.7.2.3.1 For other access rights



For other access rights, see the [Information>>>Access rights per profiles](#) section.

3.7.2.4 CLI commands

whoami

Description

whoami displays current user information:

- Username
- Profile
- Realm

logout

Description

Logout the current user.

Help

```
logout
<cr> logout the user
```

3.7.2.4.1 For other CLI commands



See the CLI commands in the [Information>>>CLI](#) section.

3.7.2.5 Troubleshooting

How do I log in if I forgot my password?

Action

- Ask your administrator for password initialization.
- If you are the main administrator, your password can be reset manually by following steps described in the [Servicing the Network Management Module>>>Recovering main administrator password](#) .

3.7.2.5.1 For other issues



For details on other issues, see the [Troubleshooting](#) section.

3.7.2.6 Save and Restore

	SRR section	SRR sub section	Settings	Possible values
Password settings	accountService	passwordRules	strength minLengthminUpperCase minLowerCase minDigit minSpecialCharacter	Numbers: refer to default settings an possible parameters for constraints.
Password expiration			expiration expiration enabled afterDays defaultAccountNeverExpires	true/false Number: refer to default settings an possible parameters for constraints. true/false
Lock account		lockoutRules	lockoutRules enabled threshold defaultAccountNeverBlocks	true/false Number: refer to default settings an possible parameters for constraints. true
Account timeout		sessionsService	sessionTimeout sessionLeaseTime	Numbers: refer to default settings an possible parameters for constraints.
Local users		PredefinedAccounts	credentials enabled username passwordExpired locked	true/false String: refer to default settings an possible parameters for constraints. true/false

			profile password plaintext cyphered	true/false administrators/operators/viewers String: refer to default settings an possible parameters for constraints. -
--	--	--	---	--

3.7.2.6.1 Additional information

 For details on Save and Restore, see the [Save and Restore](#) section.

3.7.3 Remote users

3.7.3.1 LDAP

LDAP

🔑 Configure
📁 Profile mapping
🗑️ Delete

Name	Address	Port	Security	Certificate	Status
Please note that there is no configured server.					

The table shows all the supported servers and includes the following details:

- Name
- Address
- Port
- Security
- Certificate
- Status – Status could take following values – Unreachable/Active

3.7.3.1.1 Actions

a Configure

LDAP configuration
✕

<p>Activity</p> <p>Active No</p> <hr/> <p>Primary server</p> <p>Name * Primary</p> <hr/> <p>Hostname * </p> <hr/> <p>Port 636</p> <hr/> <p>Secondary server</p> <p>Name </p> <hr/> <p>Hostname </p> <hr/> <p>Port </p> <hr/>	<p>Security</p> <p><input checked="" type="checkbox"/> Verify server certificate</p> <p>SSL SSL</p> <hr/> <p>Credentials</p> <p><input type="checkbox"/> Anonymous search bind</p> <p>Search user DN *</p> <hr/> <p>Password </p> <hr/> <p>Search base</p> <p>Search base DN dc=example,dc=com</p> <hr/>	<p>Request parameters</p> <p>User base DN * ou=people,dc=example,dc=com</p> <hr/> <p>User name attribute * uid</p> <hr/> <p>UID attribute * uidNumber</p> <hr/> <p>Group base DN * ou=group,dc=example,dc=com</p> <hr/> <p>Group name attribute * gid</p> <hr/> <p>GID attribute * gidNumber</p> <hr/>
---	---	---

Save

1. Enable LDAP to be able to configure settings
2. Press **Configure** to access the following LDAP settings:
 - Connectivity
 - Security
 - SSL – None/Start TLS/SSL
 - Verify server certificate
 - Primary server – Name/Hostname/Port
 - Secondary server – Name/Hostname/Port
 - Credentials – Anonymous search bind/Search user DN/Password
 - User base DN
 - User name attribute
 - Group base DN
 - Group name attribute
 - GID attribute
2. Click **Save**.

b Profile mapping

Profile mapping ✕

Remote group	Local profile
<hr/>	<hr/> ▼
<hr/>	<hr/> ▼
<hr/>	<hr/> ▼
<hr/>	<hr/> ▼
<hr/>	<hr/> ▼

Save



For the list of access rights per profile refer to the section [Full documentation>>>Information>>>Access rights per profiles](#).

1. Press **Profile mapping** to map remote groups to local profiles.
2. Click **Save**.

c Users preferences



All users preferences will apply to all remote users (LDAP, RADIUS).

Remote Users preferences ×

Global Settings

Language
English ▼

Temperature
°C ▼

Date format
m/d/Y ▼

Time format
24h ▼

Save

1. Press **Users preferences** to define preferences that will apply to all newly logged in LDAP users

- Language
- Temperature
- Date format
- Time format

2. Click **Save**.

3.7.3.2 RADIUS



Radius is not a secured protocol, for a maximum security, it is recommended to use LDAP over TLS.

RADIUS
[Configure](#)
[Profile mapping](#)
[Delete](#)

Name	Address	Status
Please note that there is no configured server.		

The table shows all the supported servers and includes the following details:

- Name - descriptive name for the RADIUS server
- Address - hostname or IP address for the RADIUS server
- Status

3.7.3.2.1 Actions

a Configure

RADIUS configuration
✕

<p>Activity</p> <p>Active No ▼</p> <hr/> <p>Primary server</p> <p>Name <input style="width: 90%;" type="text"/></p> <p>Secret <input style="width: 90%;" type="text"/></p> <p>Address * <input style="width: 90%;" type="text"/></p> <p>UDP port 1812</p> <p>Time out (sec) 3</p>	<p>Authentication</p> <p>Authentication protocol PAP</p> <p>Retry number 0</p> <p>Secondary server</p> <p>Name <input style="width: 90%;" type="text"/></p> <p>Secret <input style="width: 90%;" type="text"/></p> <p>Address * <input style="width: 90%;" type="text"/></p> <p>UDP port 1812</p> <p>Time out (sec) 3</p>
--	---

1. Enable Radius to be able to configure settings
2. Press **Configure** to access the following RADIUS settings:
 - Primary server
 - Name - descriptive name for the RADIUS server
 - Secret - a shared secret between the client and the RADIUS server
 - Address - hostname or IP address for the RADIUS server
 - UDP port - the UDP port for the RADIUS server (1812 by default)
 - Time out (s) - length of time the client waits for a response from the RADIUS server
 - Secondary server
 - Name - descriptive name for the RADIUS server
 - Secret - a shared secret between the client and the RADIUS server
 - Address - hostname or IP address for the RADIUS server
 - UDP port - the UDP port for the RADIUS server (1812 by default)
 - Time out (s) - length of time the client waits for a response from the RADIUS server
2. Click **Save**.

b Profile mapping

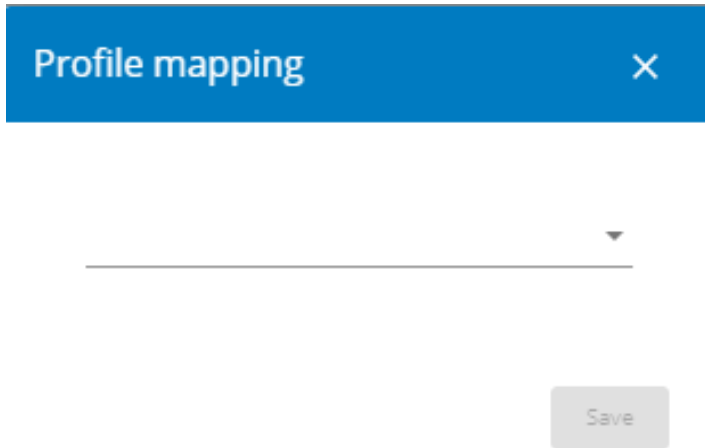

For the list of access rights per profile refer to the section [Full documentation>>>Information>>>Access rights per profiles](#).

1. Press **Profile mapping** to map RADIUS profile to local profiles.

- Attribute - The attribute value
- Vendor - The vendor value associated to the attribute
- Value - The value of the attribute needed for this mapping
- Profile - the local profile you want users to be mapped

Note: See your RADIUS protocol provider documentation to define the mapping and for further information.

2. Click **Save**.

c Users preferences

Remote Users preferences
✕

Global Settings

Language
English ▼

Temperature
°C ▼

Date format
m/d/Y ▼

Time format
24h ▼

1. Press **Users preferences** to define preferences that will apply to all RADIUS users

- Language
- Temperature
- Date format
- Time format

2. Click **Save**.

3.7.3.3 Default settings and possible parameters - Remote users

	Default setting	Possible parameters
LDAP	Configure <ul style="list-style-type: none"> • Active – No • Security <ul style="list-style-type: none"> SSL – SSL Verify server certificate – enabled • Primary server <ul style="list-style-type: none"> Name – Primary Hostname – blank Port – 636 • Secondary server <ul style="list-style-type: none"> Name – blank Hostname – blank Port – blank • Credentials <ul style="list-style-type: none"> Anonymous search bind – disabled 	Configure <ul style="list-style-type: none"> • Active – No/yes • Security <ul style="list-style-type: none"> SSL – None/Start TLS/SSL Verify server certificate – disabled/enabled • Primary server <ul style="list-style-type: none"> Name – 128 characters maximum Hostname – 128 characters maximum Port – x-xxx • Secondary server <ul style="list-style-type: none"> Name – 128 characters maximum Hostname – 128 characters maximum Port – x-xxx • Credentials <ul style="list-style-type: none"> Anonymous search bind – disabled/enabled Search user DN – 1024 characters



	<p>Search user DN – blank Password – blank</p> <ul style="list-style-type: none"> • Search base • Search base DN – dc=example,dc=com • Request parameters • User base DN – ou=people,dc=example,dc=com • User name attribute – uid • UID attribute – uidNumber • Group base DN – ou=group,dc=example,dc=com • Group name attribute – gid • GID attribute – gidNumber <p>Profile mapping – no mapping</p> <p>Users preferences</p> <ul style="list-style-type: none"> • Language – English • Temperature unit – °C (Celsius) • Date format – m/d/Y • Time format – hh:mm:ss (24h) 	<p>maximum</p> <p>Password – 128 characters maximum</p> <ul style="list-style-type: none"> • Search base • Search base DN – 1024 characters maximum • Request parameters • User base DN – 1024 characters maximum <p>User name attribute – 1024 characters maximum</p> <p>UID attribute – 1024 characters maximum</p> <p>Group base DN – 1024 characters maximum</p> <p>Group name attribute – 1024 characters maximum</p> <p>GID attribute – 1024 characters maximum</p> <p>Profile mapping – up to 5 remote groups mapped to local profiles</p> <p>Users preferences</p> <ul style="list-style-type: none"> • Language – English, French, German, Italian, Japanese, Russian, Simplified Chinese, Spanish, Traditional Chinese • Temperature unit – °C (Celsius)/°F (Fahrenheit) • Date format – MM-DD-YYYY / YYYY-MM-DD / DD-MM-YYY / DD.MM.YYY / DD/MM/YYY / DD MM YYYY • Time format – hh:mm:ss (24h) / hh:mm:ss (12h)
RADIUS	<p>Configure</p> <ul style="list-style-type: none"> • Active – No • Retry number – 0 • Primary server • Name – blank • Secret – blank • Address – blank • UDP port – 1812 • Time out – 3 • Secondary server • Name – blank • Secret – blank • Address – blank • UDP port – 1812 • Time out – 3 <p>Users preferences</p> <ul style="list-style-type: none"> • Language – English • Temperature unit – °C (Celsius) • Date format – m/d/Y • Time format – hh:mm:ss (24h) 	<p>Configure</p> <ul style="list-style-type: none"> • Active – Yes/No • Retry number – 0 to 128 • Primary server • Name – 128 characters maximum • Address – 128 characters maximum • Secret – 128 characters maximum • UDP port – 1 to 65535 • Time out – 3 to 60 • Secondary server • Name – 128 characters maximum • Address – 128 characters maximum • Secret – 128 characters maximum • UDP port – 1 to 65535 • Time out – 3 to 60 <p>Users preferences</p> <ul style="list-style-type: none"> • Language – English, French, German, Italian, Japanese, Russian, Simplified Chinese, Spanish, Traditional Chinese • Temperature unit – °C (Celsius) • Date format – MM-DD-YYYY • Time format – hh:mm:ss (24h)

3.7.3.3.1 For other settings



For other settings, see the [Information>>>Default settings parameters](#) section.

3.7.3.4 Access rights per profiles

	Administrator	Operator	Viewer
Remote users			

3.7.3.4.1 For other access rights



For other access rights, see the [Information>>>Access rights per profiles](#) section.

3.7.3.5 CLI commands

ldap-test

Description

Ldap-test help to troubleshoot LDAP configuration issues or working issues.

Help

```
Usage: ldap-test <command> [OPTION]...
Test LDAP configuration.
```

Commands:

```
ldap-test -h, --help, Display help page
```

```
ldap-test --checkusername <username> [--primary|--secondary] [-v]
```

Check if the user can be retrieve from the LDAP server

```
<username>      Remote username to test
--primary       Force the test to use primary server (optional)
--secondary    Force the test to use secondary server (optional)
-v,--verbose   Print the exchanges with LDAP server (optional)
```

```
ldap-test --checkauth <username> [--primary|--secondary] [-v]
```

Check if remote user can login to the card

```
<username>      Remote username to test
-p,--primary    Force the test to use primary server (optional)
-s,--secondary  Force the test to use secondary server (optional)
-v,--verbose    Print the exchanges with LDAP server (optional)
```

```
ldap-test --checkmappedgroups [--primary|--secondary] [-v]
```

Check LDAP mapping

```
-p,--primary    Force the test to use primary server (optional)
-s,--secondary  Force the test to use secondary server (optional)
-v,--verbose    Print the exchanges with LDAP server (optional)
```

Quick guide for testing:

In case of issue with LDAP configuration, we recommend to verify the configuration using the commands in the following order:

1. Check user can be retrieve on the LDAP server

```
ldap-test --checkusername <username>
```

2. Check that your remote group are mapped to the good profile

```
ldap-test --checkmappedgroups
```

3. Check that the user can connect to the card

```
ldap-test --checkauth <username>
```

logout

Description

Logout the current user.

Help

```
logout
<cr> logout the user
```

whoami

Description

whoami displays current user information:

- Username
- Profile
- Realm

3.7.3.5.1 For other CLI commands



See the CLI commands in the [Information>>>CLI](#) section.

3.7.3.6 Troubleshooting

How do I log in if I forgot my password?

Action

- Ask your administrator for password initialization.
- If you are the main administrator, your password can be reset manually by following steps described in the [Servicing the Network Management Module>>>Recovering main administrator password](#) .

LDAP configuration/commissioning is not working

Refer to the section [Servicing the Network Management Module>>>Commissioning/Testing LDAP](#) .

3.7.3.6.1 For other issues



For details on other issues, see the [Troubleshooting](#) section.

3.7.3.7 Save and Restore

	SRR section	Sub section	Sub section	Sub section	Sub section	Settings	Sub settings	Possible values	
LDAP	ldap	1.0	settings	enabled					true/false
				connectivity	primaryServer	name		String: refer to default settings an possible parameters for constraints.	
						uri		String: refer to default settings an possible parameters for constraints.	
						port		Unsigned number	
				secondaryServer	name		String: refer to default settings an possible parameters for constraints.		
					uri		String: refer to default settings an possible parameters for constraints.		
					port		Unsigned number		
				userDomain	nameAttribute		String: refer to default settings an possible parameters for constraints.		
					dn		String: refer to default settings an possible parameters for constraints.		
				groupDomain	nameAttribute		String: refer to default settings an possible		

								parameters for constraints.	
							dn	String: refer to default settings an possible parameters for constraints.	
						bind	dn	String: refer to default settings an possible parameters for constraints.	
							password	plaintext	String: refer to default settings an possible parameters for constraints.
								ciphared	String: refer to default settings an possible parameters for constraints.
						security	type	1: ssl 2: starttls 3: none	
							verifyCertificate	true/false	
						mappings	remoteGroup	String: refer to default settings an possible parameters for constraints.	
							profileName	<ul style="list-style-type: none"> administrators viewers operators 	
						preferences	language	String: refer to default settings an possible parameters for constraints.	
							dateFormat	String: refer to default settings an possible parameters for constraints.	
							timeFormat	String: refer to default settings an possible parameters for constraints.	
							temperatureUnit	String: refer to default settings an possible parameters for constraints.	
							licenceAgreement	String: refer to default settings an possible parameters for constraints.	
	SRR section	Sub section	Sub section	Sub section	Sub section	Settings	Sub settings	Possible values	

RADIUS	radius	1.0	settings	enabled		true/false	
				connectivity	protocol	<ul style="list-style-type: none"> ▪ pap ▪ chap 	
					primaryServer	name	String: refer to default settings an possible parameters for constraints.
						secret	String: refer to default settings an possible parameters for constraints.
						uri	String: refer to default settings an possible parameters for constraints.
						port	Unsigned number
						timeout	Unsigned number
						retryCount	Unsigned number
					secondaryServer	name	String: refer to default settings an possible parameters for constraints.
						secret	String: refer to default settings an possible parameters for constraints.
						uri	String: refer to default settings an possible parameters for constraints.
						port	Unsigned number
						timeout	Unsigned number
						retryCount	Unsigned number
				nas	identifier	String: refer to default settings an possible parameters for constraints.	
					ip	String: refer to default settings an possible parameters for constraints.	
				mappings		profile	String: refer to default settings an possible parameters for constraints.
						attribute	Number
						value	Number

					vendor	Number
				preferences	language	String: refer to default settings an possible parameters for constraints.
					dateFormat	String: refer to default settings an possible parameters for constraints.
					timeFormat	String: refer to default settings an possible parameters for constraints.
					temperatureUnit	String: refer to default settings an possible parameters for constraints.
					licenceAgreement	String: refer to default settings an possible parameters for constraints.

3.7.3.7.1 Additional information



For details on Save and Restore, see the [Save and Restore](#) section.

3.7.4 Network & Protocol

3.7.4.1 Network

3.7.4.1.1 IPv4



Any modifications are applied after the Network Module reboots.

IPv4 details ✕

Mode *
DHCP

Address *
192.168.1.1

Netmask *
255.255.255.0

Gateway *
192.168.1.1

Save

Press the **Edit** button to configure the network settings, select either the Manual or DHCP settings option:

IPV4	
Status	192.168.1.1
Mode	DHCP
Address	192.168.1.1
Netmask	255.255.255.0
Gateway	192.168.1.1
Edit	

a Manual

Select Manual, and then enter the network settings if the network is not configured with a BootP or DHCP server.

- Enter the IP Address.
The Network Module must have a unique IP address for use on a TCP/IP network.
- Enter the netmask.
The netmask identifies the class of the sub-network the Network Module is connected to.
- Enter the gateway address.
The gateway address allows connections to devices or hosts attached to different network segments.

b DHCP

Select dynamic DHCP to configure network parameters by a BootP or DHCP server.

If a response is not received from the server, the Network Module boots with the last saved parameters from the most recent power up. After each power up, the Network Module makes five attempts to recover the network parameters.

3.7.4.1.2 IPv6

IPV6	
Enable	<input checked="" type="checkbox"/> Active
Status	<input type="text" value=""/>
Mode	DHCP
Address	<input type="text" value=""/>
<input type="button" value="Edit"/>	

IPv6 status and the first three addresses are displayed.

Press the **Edit** button to configure the network settings and get more information and access to the following IPv6 details.

IPv6 details ✕

Current configuration	Address settings
Address <input type="text" value="fe80::c000:0000:0000:0000"/>	Enabled <input type="checkbox"/>
Gateway	Active <input type="checkbox"/>
	Mode * <input type="text" value="DHCP"/>
	Address * <input type="text" value=""/>
	Prefix * <input type="text" value=""/>
	Gateway * <input type="text" value=""/>

a Current configuration

- Address
- Gateway

b Address settings

- Enabled
- Mode (Manual/DHCP)
- Address
- Prefix
- Gateway

3.7.4.1.3 DNS/DHCP

DNS / DHCP	
Mode	DHCP
FQDN	myHostname
Primary DNS	192.168.1.1
Secondary DNS	192.168.1.1
<input type="button" value="Edit"/>	

The DNS is a hierarchical decentralized naming system for computers, services, or other resources connected to the Internet or a private network.

Press the **Edit** button to configure the network settings, select either the Static or Dynamic settings.

Domain configuration
×

Hostname *
myHostname

Mode *
DHCP

Domain name *

Primary DNS *
192.168.1.1

Secondary DNS *
192.168.1.1

a Manual

- Enter the Network Module Hostname.
- Enter the Network Module Domain name.
- Primary DNS server.
Enter the IP address of the DNS server that provides the translation of the domain name to the IP address.

- Secondary DNS server.
Enter the IP address of the secondary DNS server that provides the translation of the domain name to the IP address when the primary DNS server is not available.

b DHCP

- Enter the Network Module Hostname.

3.7.4.1.4 Ethernet

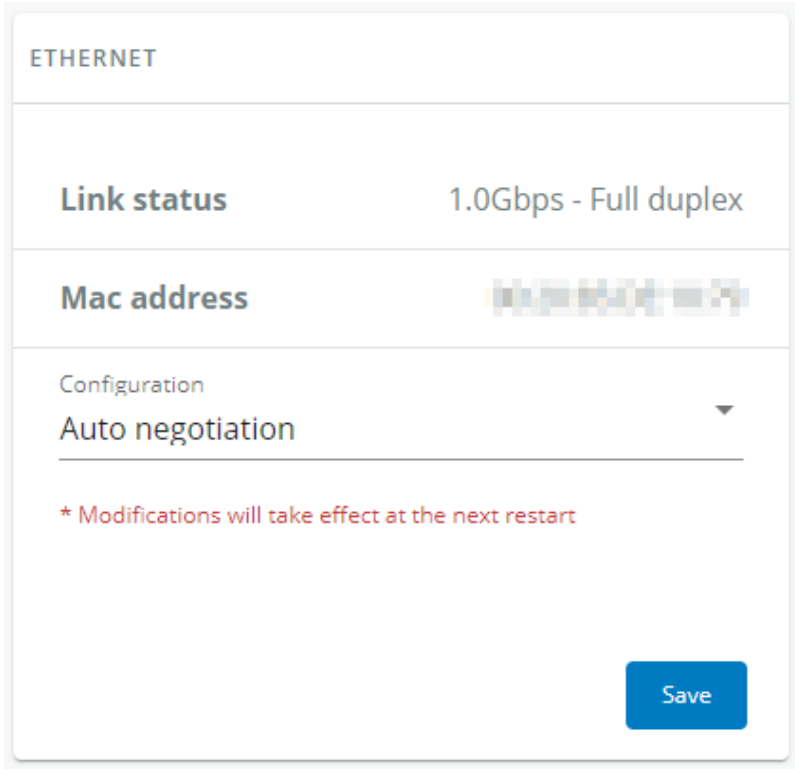

A LAN is a computer network that interconnects computers within a limited area.

The available values for LAN configuration are listed below:

- Auto negotiation
- 10Mbps - Half duplex
- 10Mbps - Full duplex
- 100Mbps - Half duplex
- 100Mbps - Full duplex
- 1.0 Gbps - Full duplex

Any modifications are applied after the next Network Module reboot.

3.7.4.2 Protocol

This tab contains settings for communication protocols used to get information from the device through the network, such as https for web browser.

3.7.4.2.1 HTTPS

HTTPS

Port *
443

Disable Http redirection

Only https is available and http redirection can be disabled.

The default network port for https is 443. For additional security, the ports can be changed on this page.

Press **Save** after modifications.



Since only https is available, port 80 is not supported.

3.7.4.2.2 Syslog

SYSLOG

Inactive Active

	Name	Address	Security	Port	Protocol	Status
	Primary		TLS - Syslog Certificate	6514	TCP	Inactive
			TLS - Syslog Certificate	6514	TCP	Inactive

a Settings

This screen allows an administrator to configure up to two syslog servers.

To configure the syslog server settings:

1- **Enable** syslog.

Press **Save** after modifications.

2- **Configure** the syslog server:

Edit syslog server configuration
✕

Name * Primary	Port * 6514
Status Disabled	Protocol TCP
Hostname *	Message transfer method
SSL TLS	Using unicode byte order mask (BOM) <input type="checkbox"/>
Verify server certificate <input checked="" type="checkbox"/>	

Save

- Click the edit icon  to access settings.
- Enter or change the server name.
- Select **Yes** in the Active drop-down list to activate the server.
- Enter the Hostname and Port.
- Select the Protocol – UDP/TCP.
- In TCP, select the message transfer method – Octet counting/Non-transparent framing.
- Select the option Using Unicode BOM if needed.
- Press **Save** after modifications.

3.7.4.3 Remote Monitoring Services

This tile allows an administrator to configure and enable the Remote monitoring services on the Network Module.

REMOTE MONITORING SERVICES

Status

Activate service

Proxy *

[Advanced](#)

[Save](#)

To configure the remote monitoring connection settings:

- 1- **Enable** the Remote monitoring services
- 2- **Configure** the Proxy if needed.
- 3- **Configure** Advanced settings if so advised by Eaton service support and **Save** after modifications.

Advanced cloud settings
×

Endpoint access *

Username

Password

You are about to be connected to Eaton Remote Monitoring.
In order to do so you must have a valid service contract.
Please contact the local Eaton service team.

[Save](#)

- 4- **Save** after modifications, a disclaimer will appear.

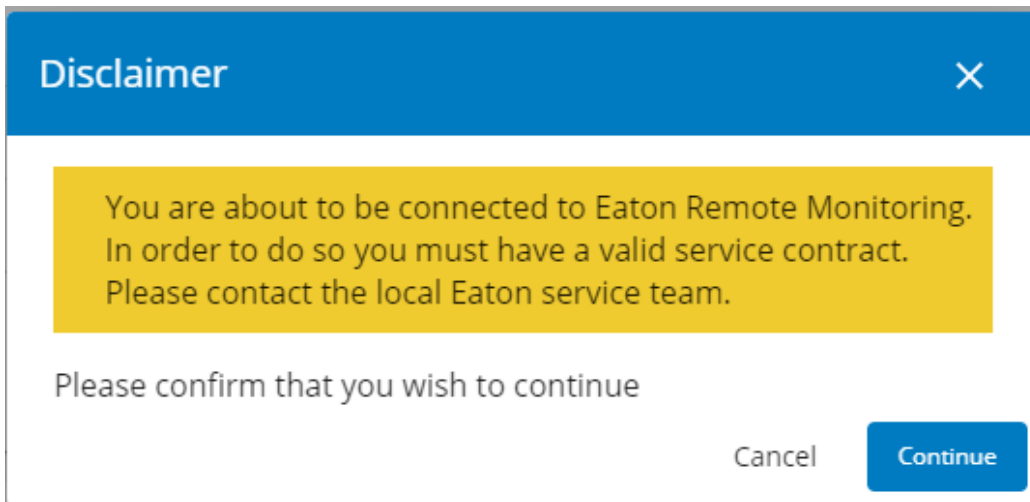

3.7.4.3.1 Status

Label	Description
Connected	The Network Module is connected and registered to the Remote Monitoring Service. Data transmission is OK.
Disabled	The Remote Monitoring Services is disabled. To enable it, you must have a valid service contract. Please contact the local Eaton service team and enable the Remote Monitoring Services on the Network Module.
Not connected	The Remote Monitoring Services is enabled, the Network Module is not connected to it but connection procedure has started.
Connecting	The Network Module is connecting to the Remote Monitoring Services: <ul style="list-style-type: none"> • DNS is set correctly • Proxy is set correctly • Certificate verification is OK
Pending approval	The Network Module is connected to the Remote Monitoring Services but not registered to it. The Network Module must be registered by Eaton service team in the Remote Monitoring Services.
Connection lost	The Network Module has lost the connection to the Remote Monitoring Services and will try to reconnect automatically.
DNS name resolution error	The Network Module connection to the Remote Monitoring Services has failed. <ul style="list-style-type: none"> • DNS is not set correctly or connection to it fails Items to check with your network administrator: <ul style="list-style-type: none"> • DNS setting in the Network Module • DNS provided by the DHCP is working • DNS address in the Network Module is correct Troubleshooting: <ul style="list-style-type: none"> • Switch to static DNS settings to troubleshoot
Proxy error	The Network Module connection to the Remote Monitoring Services has failed. <ul style="list-style-type: none"> • Proxy is not set correctly in the network module or the proxy service does not allow this connection. Items to check with your network administrator:

Label	Description
	<ul style="list-style-type: none"> Proxy URL is correctly set in the Network Module Proxy allows connection to the Internet Proxy allows HTTPs connections to the Internet Proxy does not use a custom certificate to intercept traffic <p>Troubleshooting:</p> <ul style="list-style-type: none"> Reboot the Network Module if above checking is OK and contact the service representative if it still is not working.
Certificate error	<p>The Network Module connection to the Remote Monitoring Services has failed.</p> <ul style="list-style-type: none"> Certificate verification failed <p>Items to check with your network administrator:</p> <ul style="list-style-type: none"> Proxy does not use a custom certificate to intercept traffic <p>Troubleshooting:</p> <ul style="list-style-type: none"> Reboot the Network Module if above checking is OK and contact the service representative if it still is not working.
Invalid credentials	<p>The Network Module connection to the Remote Monitoring Services has failed.</p> <ul style="list-style-type: none"> Authentication has failed <p>The Network Module is using invalid username/password to connect to the Remote Monitoring Services.</p> <p>Items to check with your Eaton service contact:</p> <ul style="list-style-type: none"> Credentials set in the Network Module Advanced settings are correct. <p>Troubleshooting:</p> <ul style="list-style-type: none"> If above checking is OK, contact the service representative.
Connection error	<p>The Network Module connection to the Remote Monitoring Services has failed for another error.</p> <p>Troubleshooting:</p> <ul style="list-style-type: none"> Contact the service representative.

3.7.4.4 Default settings and possible parameters - Network & Protocol

	Default setting	Possible parameters
IPV4	Mode — DHCP	Mode — DHCP/Manual (Address/Netmask/Gateway)
IPV6	Enable — checked Mode — DHCP	Enabled — Active/Inactive Mode — DHCP/Manual (Address/Prefix/Gateway)
DNS/DHCP	Hostname — <i>device</i> [MAC address] Mode — DHCP	Hostname — 128 characters maximum Mode :DHCP/Manual (Domain name/Primary DNS/Secondary DNS)
Ethernet	Configuration — Auto negotiation	Configuration — Auto negotiation - 10Mbps - Half duplex - 10Mbps - Full duplex - 100Mbps - Half duplex - 100Mbps - Full duplex - 1.0 Gbps - Full duplex
HTTPS	Port — 443	Port — x-xxx
Syslog	Inactive	Inactive/Active

	<ul style="list-style-type: none"> • Server#1 <ul style="list-style-type: none"> Name – Primary Status – Disabled Hostname – empty Port – 514 Protocol – UDP Message transfer method – Non transparent framing Using unicode byte order mask (BOM) – disabled • Server#2 <ul style="list-style-type: none"> Name – empty Status – Disabled Hostname – empty Port – 514 Protocol – UDP Message transfer method – Disabled in UDP Using unicode byte order mask (BOM) – disabled 	<ul style="list-style-type: none"> • Server#1 <ul style="list-style-type: none"> Name – 128 characters maximum Status – Disabled/Enabled Hostname – 128 characters maximum Port – x-xxx Protocol – UDP/TCP Message transfer method – Non transparent framing Using unicode byte order mask (BOM) – disable/enable • Server#2 <ul style="list-style-type: none"> Name – 128 characters maximum Status – Disabled/Enabled Hostname – 128 characters maximum Port – x-xxx Protocol – UDP/TCP Message transfer method (in TCP) – Octet counting/Non transparent framing Using unicode byte order mask (BOM) – disable/enable
--	--	--

3.7.4.4.1 For other settings



For other settings, see the [Information>>>Default settings parameters](#) section.

3.7.5 SNMP

This tab contains settings for SNMP protocols used for network management systems.



Changes to authentication settings need to be confirmed by entering a valid password for the active user account.

3.7.5.1 SNMP tables



The default port for SNMP is 161 and normally this should not be changed. Some organizations prefer to use non-standard ports due to cybersecurity, and this field allows that.

SNMP

Port *
161

Activate SNMP Supported MIBs [🔗](#)

SNMP V1

	Community	Access	Status
	public	Read only	⊖ Inactive
	private	Read/Write	⊖ Inactive

SNMP V3

	Users	Access	Security level	Status
	readonly	Read only	Auth (SHA 256) , Priv (AES)	⊖ Inactive
	readwrite	Read/Write	Auth (SHA 256) , Priv (AES)	⊖ Inactive

[Save](#)

SNMP monitoring Battery status, power status, events, and traps are monitored using third-party SNMP managers.

To query SNMP data, you do not need to add SNMP Managers to the Notified Application page.

To set-up SNMP managers:

- Configure the IP address.
- Select SNMP v1 or v1 and v3.
- Compile the MIB you selected to be monitored by the SNMP manager.

List of supported MIBs: *xUPS MIB | Standard IETF UPS MIB (RFC 1628) | Sensor MIB*

Press the **Supported MIBs** button to download the MIBs.

3.7.5.1.1 Settings

This screen allows an administrator to configure SNMP settings for computers that use the MIB to request information from the Network Module.

Default ports for SNMP are 161 (SNMP v1 and v3, set/get) and 162 (traps). These ports can be changed on the settings screen for additional security.

To configure the SNMP settings:

a Enable the SNMP agent

In addition to this also v1 and/or v3 must be enabled, along with appropriate communities and activated user accounts to allow SNMP communication.

Press **Save** after modifications.

b Configure the SNMP V1 settings:

Community name *
public

Enabled *
Inactive

Access **Read only**

Save

1. Click the edit icon on either Read Only or Read/Write account to access settings: 
2. Enter the SNMP Community Read-Only string. The Network Module and the clients must share the same community name to communicate.
3. Select **Active** in the Enabled drop-down list to activate the account.
4. Access level is set to display information only.

c Configure the SNMP V3 settings:

Edit SNMP V3 user
✕

User name *
readonly

Enabled *
Inactive

Access *
Read only

Security *
Auth, Priv

Authentication algorithm *
SHA 256

Password

Confirm Password

Privacy algorithm *
AES

Key

Confirm key

Please enter your own password to confirm

Confirm Password *

1. Click the edit icon on either Read Only or Read/Write account to access settings: 
2. Edit the user name.
3. Select **Active** in the Enabled drop-down list to activate the account.
4. Select access level.
 - **Read only**—The user does not use authentication and privacy to access SNMP variables.
 - **Read/Write**—The user must use authentication, but not privacy, to access SNMP variables.
5. Select the communication security mechanism.
 - **Auth, Priv**—Communication with authentication and privacy.
 - **Auth, No Priv**—Communication with authentication and without privacy.
 - **No Auth, No Priv**—Communication without authentication and privacy.

6. If Auth is selected on the communication security mechanism, select the Authentication algorithms.



It is recommended to set SHA256/SHA384/SHA512 with the AES192/AES256 Privacy algorithms.

- **SHA**— SHA1 is not recommended as it is not secured.
- **SHA256**—fill in password and privacy keys. The password can be between 8 and 24 characters and use a combination of alphanumeric and the following special characters <>&@#%_=:;,./?|\$*.
- **SHA384**—fill in password and privacy keys. The password can be between 8 and 24 characters and use a combination of alphanumeric and the following special characters <>&@#%_=:;,./?|\$*.
- **SHA512**—fill in password and privacy keys. The password can be between 8 and 24 characters and use a combination of alphanumeric and the following special characters <>&@#%_=:;,./?|\$*.
- AES / AES192 / AES256

7. If Priv is selected on the communication security mechanism, select the Privacy algorithms.





It is recommended to set AES192/AES256 with the SHA256/SHA384/SHA512 Authentication algorithms.

- **AES**— fill in password and privacy keys. The password can be between 8 and 24 characters and use a combination of alphanumeric and the following special characters <>&@#%_=:;,./?|\$*.
- **AES192**—fill in password and privacy keys. The password can be between 8 and 24 characters and use a combination of alphanumeric and the following special characters <>&@#%_=:;,./?|\$*.
- **AES256**—fill in password and privacy keys. The password can be between 8 and 24 characters and use a combination of alphanumeric and the following special characters <>&@#%_=:;,./?|\$*.

8. Enter your own login password and click **Save**.

3.7.5.2 Trap receivers

TRAP RECEIVERS				
<div style="display: flex; justify-content: space-between; align-items: center;">  New  Delete  Test trap </div>				
Application name	Host	Protocol	Port	Status

The table shows all the trap receivers and includes the following details:

- **Application name**
- **Host**
- **Protocol**
- **Port**
- **Status:** Active/Inactive/Error(configuration error)

3.7.5.2.1 Actions

a Add

New trap receiver
✕

Enabled <input type="text" value="No"/>	Protocol <input type="text" value="V1"/>
Application Name * <input type="text"/>	User <input type="text"/>
Hostname or IP address... <input type="text"/>	Trap community * <input type="text"/> <div style="color: red; font-size: small; margin-top: 2px;">The field is required</div>
Port * <input type="text" value="162"/>	

1. Press the **New** button to create new trap receivers.

2. Set following settings:

- Enabled – Yes/No
- Application name
- Hostname or IP address
- Port
- Protocol – V1/V3
- Trap community (V1) / User (V3)

3. Press the **SAVE** button.

b Remove

Select a trap receiver and press the **Delete** button to remove it.

c Edit

Press the pen icon to edit trap receiver information and access to its settings: 

d Test trap

Press the **Test trap** button to send the trap test to all trap receivers.

Separate window provides the test status with following values:

- In progress
- Request successfully sent
- invalid type



For details on SNMP trap codes, see the [Information>>>SNMP traps](#) section.

3.7.5.3 Link to SNMP traps

- [UPS Mib](#)
- [Sensor Mib](#)

3.7.5.4 Default settings and possible parameters - SNMP



	Default setting	Possible parameters
SNMP	Activate SNMP — disabled Port — 161 SNMP V1 — disabled <ul style="list-style-type: none"> • Community #1 — public Enabled — Inactive Access — Read only • Community #2 — private Enabled — Inactive Access — Read/Write SNMP V3 — enabled <ul style="list-style-type: none"> • User #1 — readonly Enabled — Inactive Access — Read only Authentication — Auth (SHA-1) Password — empty Confirm password — empty Privacy — Secured - AES Key — empty Confirm key — empty • User#2 — readwrite Enabled — Inactive Access — Read/Write Authentication — Auth (SHA-1) Password — empty Confirm password — empty Privacy — Secured - AES Key — empty Confirm key — empty 	Activate SNMP — disable/enable Port — x-xxx SNMP V1 — disable/enable <ul style="list-style-type: none"> • Community #1 — 128 characters maximum Enabled — Inactive/Active Access — Read only • Community #2 — 128 characters maximum Enabled — Inactive/Active Access — Read/Write SNMP V3 — disable/enable <ul style="list-style-type: none"> • User #1 — 32 characters maximum Enabled — Inactive/Active Access — Read only/Read-Write Authentication — Auth (SHA-1)/None Password — 128 characters maximum Confirm password — 128 characters maximum Privacy — Secured - AES/None Key — 128 characters maximum Confirm key — 128 characters maximum • User#2 — 32 characters maximum Enabled — Inactive/Active Access — Read only/Read-Write Authentication — Auth (SHA-1)/None Password — 128 characters maximum Confirm password — 128 characters maximum Privacy — Secured - AES/None Key — 128 characters maximum Confirm key — 128 characters maximum
Trap receivers	No trap	Enabled — No/Yes Application name — 128 characters maximum Hostname or IP address — 128 characters maximum Port — x-xxx Protocol — V1 Trap community — 128 characters maximum

3.7.5.4.1 For other settings



For other settings, see the [Information>>>Default settings parameters](#) section.

3.7.5.5 Access rights per profiles

	Administrator	Operator	Viewer
SNMP			

3.7.5.5.1 For other access rights



For other access rights, see the [Information>>>Access rights per profiles](#) section.

3.7.5.6 Troubleshooting

SNMPv3 password management issue with Save and Restore

Affected FW versions

This issue affects SNMP **configuration** done on versions prior to 1.7.0 when applied to versions 1.7.0 or above.

Symptom

SNMPv3 connectivity is not properly working after a restore settings on a 1.7.0 version or above.

Cause

The SNMPv3 was **configured** prior to 1.7.0.

In that case, SNMPv3 configuration is not well managed by the Save and by the Restore settings.

Action

Reconfigure your SNMPv3 users and passwords on versions 1.7.0 or above and Save the settings.

The SNMPv3 configuration can then be Restored.

3.7.5.6.1 For other issues



For details on other issues, see the [Troubleshooting](#) section.

3.7.5.7 Save and Restore

	SRR section	SRR sub section	Settings	Sub settings	Example
SNMP	snmp		enabled		true
			port		Number: refer to default settings an possible parameters for constraints.
	v1	enabled		true	

		communities	readOnly		
		Name	String: refer to default settings an possible parameters for constraints.		
		Enabled			
		readWrite			
		Name	String: refer to default settings an possible parameters for constraints.		
		Enabled	true/false		
		v3	enabled		true
		users	name	String: refer to default settings an possible parameters for constraints.	
			allowWrite	true/false	
			enabled	true/false	
	auth				
	enabled		true/false		
	algorithm		*		
	password				
	plaintext		String: refer to default settings an possible parameters for constraints.		
	cyphered		-		
	priv				
	enabled		true/false		
	algorithm		*		
	password				
plaintext	String: refer to default settings an possible parameters for constraints.				
cyphered	-				
name	String: refer to default settings an possible parameters for constraints.				
allowWrite	true/false				
enabled	true/false				
auth					

				enabled	true/false				
				algorithm	*				
				password					
				plaintext	String: refer to default settings an possible parameters for constraints.				
				cyphered	-				
				priv					
				enabled	true/false				
				algorithm	*				
				password					
				plaintext	String: refer to default settings an possible parameters for constraints.				
				cyphered	-				
				traps			receivers	name	String: refer to default settings an possible parameters for constraints.
								host	*
								port	Number: refer to default settings an possible parameters for constraints.
community	*								
protocol	1 : V1 3 : V3								
user	*								
enabled	true/false								

3.7.5.7.1 Additional information



For details on Save and Restore, see the [Save and Restore](#) section.

3.7.6 Industrial protocols

3.7.6.1 Modbus



This section is only for the Modbus Network ModuleINDGW
 For instructions on connecting Modbus RTU see the section [Installing the Network Management Module>>>Wiring the RS-485 Modbus RTU terminal>>>Configuring the termination.](#)
 For instructions on configuring Modbus see the section [Installing the Network Management Module>>>Configuring Modbus.](#)

3.7.6.1.1 Configuration

a Modbus RTU

 MODBUS CONFIGURATION

Modbus RTU

 In service

Baud rate
9600 bps

Parity

None

Even

Odd

Stop bits

1

2

Save

The following Modbus RTU settings are configurable:

- Enable
- Baud rate
- Parity
- Stop bits

b Modbus TCP

 MODBUS CONFIGURATION

Modbus TCP

 In service

Port
502



Save



The following Modbus TCP settings are configurable:

- Enable
- Port

3.7.6.1.2 Mapping configuration

 MODBUS MAPPING CONFIGURATION

<input type="checkbox"/>		Custom name	↑ MAP	Transport	Access	Illegal read	IP filtering	Coil/register base address shift
<input type="checkbox"/>		my UID 0 map	Eaton PowerXpert UID 0 compatible	TCP @ 1	Read only	Return exception	*	0 based
<input type="checkbox"/>		my MS MAP	Eaton ModbusMS compatible	TCP @ 2	Read only	Return exception	*	0 based

a Mapping configuration table

The table shows all the mapping configuration and includes the following details:

- Custom name
- MAP
- Transport
- Access
- Illegal read
- IP filtering
- Coil/register base address shift

b Actions

Add

Press the **New** button to create new mapping configuration.

Remove

Select a mapping configuration and press the **Delete** button to remove it.

Edit

Press the pen logo to edit mapping configuration:



Mapping configuration



Custom name *

MAP *

Transport *

Device ID *

Access *

Illegal read behaviour *

Coil/register base address shift *

IP filtering

Save

You will get access to the following settings:

- Custom name
- MAP
- Transport
- Device ID
- Access
- Illegal read behaviour
- Coil/register base address shift
- IP filtering

Supported MAPs

Press the **Supported MAPs** button to download the MAPs.

Supported Modbus MAPs



Name	Version	0 based	1 based
Eaton ModbusMS compatible	1.0		
Eaton PowerXpert UID 0 compatible	1.0		
Card System Information	1.0		



File is generated in real time and will take into account the Device capabilities and values at the time of the generation.
Table in the downloaded file will show all possible registers, only the one showing Available equal to True will be supported by your system.

Mapping file content:

- Address (hex, 0/1-based): register address in hexadecimal
- Address (dec, 0/1 based): register address in decimal
- Type: Register/Discrete
- Size in bytes
- Number of Modbus registers
- Writable: True/False
- Representation: Int16/UInt16/String/Boolean/...
- Name
- Description
- Unit
- Status to 0: status when the register equal 0
- Status to 1: status when the register equal 1
- Available: True/False – Shows if the register is available on current Device
- Value: Shows current value of the register on current Device

3.7.6.2 BACnet

BACnet/IP communication provides read-only data from Building Automation Systems (BASs) so that the Network Module can be easily integrated in a BAS alongside other BACnet /IP capable devices.

3.7.6.2.1 Configuration

BACNET IP CONFIGURATION
[Get EPICS file](#)

BACnet IP
✔ In service

Broadcast management device

Device Id *

Device Name *

Device connection control password

Local port Port *

MAC address

BACnet/IP device IP address *

Time to live Minutes * Seconds *

The following BACnet settings are configurable or displayed:

- **Enable BACnet IP**
- **Device Id** – Must be unique in BACnet network. Automatically generated from Ethernet MAC address to prevent collisions.
- **Device Name** – Must be unique in BACnet network. Automatically generated from manufacturer name and serial number to prevent collisions.
- **Device connection control password** – Password is required with DCC commands; if it has not been configured, then these commands will not be authorized.
- **Enable Broadcast management device** – To register as a Foreign Device with the BACnet BBDM indicated in IP address field.
- **BBDM BACnet/IP device** – Automatically generated and modifiable, IPv4 address of the BBMD we will register with.
- **BBDM Time to live** – The BBMD time to live (in seconds), we must "ping" the BBMD we are registered with within this time.

a Actions

Get EPICS file

An electronic protocol implementation conformance statement (EPICS) file provides verification that devices meet BACnet standards for objects and services.

This allows EPICS files to provide data to software test programs and for system configuration at the BAS.

Press the **Get EPICS file** button to download the EPICs.



File is generated in real time and will take into account the Device capabilities and values at the time of the generation.
The file is in text protocol information (.TPI) format and is machine and human readable, open it with any text reader to view it.

3.7.6.3 Default settings and possible parameters - Industrial protocols



Modbus and BACnet settings are only for the INDGW Network Module.

	Default setting	Possible parameters
Modbus RTU	Modbus RTU — Inactive Baud rate (bps) — 19200 Parity — Even Stop bits – 1	Modbus RTU — Inactive/Active Baud rate (bps) — 1200/2400/4800/9600/19200/38400/57600/115200 Parity — None/Even/Odd Stop bits – 1/2
Modbus TCP	Modbus TCP — Inactive Port — 502	Modbus TCP — Inactive/Active Port — x-xxx
Mapping configuration	No mapping	Custom name – 128 characters maximum Map – Eaton ModbusMS compatible, Eaton PowerXpert UID 0 compatible, Card System Information Transport – RTU/TCP Access – None/Read only/Read/Write Illegal read behaviour – Return exception/Return zeros IP filtering – IP address Coil/register base address shift – No shift/Shift by 1 (JBUS)
BACnet	BACnet IP — Inactive	BACnet IP — Inactive/Active Device Id — Automatically generated, must be unique, 4194304 characters maximum Device Name — Automatically generated, must be unique, 1-255 characters maximum, only Latin letters, numbers, spaces, '_' and '!' symbols Device connection control password — 6-20 characters maximum Local port — 1-65535 characters maximum (as all the other UDP and TCP ports) MAC address — MAC address format Broadcast management device — Inactive/Active BBMD BACnet/IP device — IP address format

BBMD Time to live — 30-1800 seconds

3.7.6.3.1 For other settings



For other settings, see the [Information>>>Default settings parameters](#) section.

3.7.6.4 Access rights per profiles

	Administrator	Operator	Viewer
Industrial protocols/Modbus*	✓	✗	✗
Industrial protocols/BACnet*	✓	✗	✗

**for INDGW only*

3.7.6.4.1 For other access rights



For other access rights, see the [Information>>>Access rights per profiles](#) section.

3.7.6.5 CLI commands

modbus_message_display



This section is only for the Modbus Network Module INDGW

Description

modbus_message_display restarts the server and displays Modbus message. This command allow you to verify that Modbus server is working as expected.

Help

```
modbus_message_display
  --help  Restart server and display modbus message
  -h      Restart server and display modbus message
```

modbus_statistics

This section is only for the Modbus Network Module INDGW

Description

modbus_statistics displays Modbus RTU and TCP status and server statistics:

- Bus character overrun count
- Bus frame error count
- Bus parity error count
- Buffer overrun count

- Bus message count
- Valid message count
- CRC error count

- Incoming message count
- Discarded message count
- Processed message count
- Success returned count
- Exception returned count

Help

```
modbus_statistics          Display modbus server statistics

  -h, --help              Display the help page.
  -r, --reset             Reset modbus server statistics.
                          The counter from A1.1 to A1.4 are reset only at startup of the
server.
```

3.7.6.5.1 For other CLI commands

See the CLI commands in the [Information>>>CLI](#) section.

3.7.6.6 Troubleshooting

Modbus communication doesn't work

Symptoms

- Communication doesn't work



Refer to the section [Servicing the Network Management Module>>>Configuring Modbus](#) to get configuration and testings information.

Possible cause

- Incorrect communication parameters.

Verify that the communication parameters are set to the desired settings. For Modbus TCP configuration refer to the section [Contextual help>>>Settings>>>Modbus>>>Modbus TCP](#) .

For Modbus RTU configuration refer to the section [Contextual help>>>Settings>>>Modbus>>>Modbus RTU](#) .

- RS-485 communication lines are reversed

For two-wire networks refer to the section [Installing the Network Management Module>>>Wiring the RS-485 Modbus RTU terminal>>>Two-wire networks](#) .

For four-wire networks refer to the section [Installing the Network Management Module>>>Wiring the RS-485 Modbus RTU terminal>>>Four-wire networks](#) .

- If the Modbus Card is the last device installed in the network chain or the length of the network cable is excessive, termination needs to be enabled.

Verify the termination settings and refer to the section [Installing the Network Management Module>>>Wiring the RS-485 Modbus RTU terminal>>>Configuring the termination](#) .

3.7.6.6.1 For other issues



For details on other issues, see the [Troubleshooting](#) section.

3.7.6.7 Save and Restore

	SRR section	Settings	Sub settings	Possible values
Modbus	modbus data	tcp	enabled	true/false
			port	Number: refer to default settings an possible parameters for constraints.
		rtu	enabled	true/false
			baudrate	1: 1200pbs 2: 2400bps 3: 4800bps 4: 9600bps 5: 19200bps 6: 38400bps 7: 57600bps 8: 115200bps

		mapping configurations	parity	1: None 2: Even 3: Odd
			stopBits	1: 1 Stop bit 2: 2 Stop bits
			name	String: refer to default settings an possible parameters for constraints.
			map	Eaton ModbusMS compatible, Eaton PowerXpert UID 0 compatible, Card System Information
			transport	1: RTU 2: TCP
			transportFilter	*
			deviceld	Number: refer to default settings an possible parameters for constraints.
			access	0: None 1: Read only 3: Read/Write
			illegalReadBehavior	1: Return exception 2: return zeros
			addressBaseShift	Shift value (1,2,5,..)
			name map transport transportFilter deviceld access illegalReadBehavior addressBaseShift	Same as above
Bacnet	bacnet	configuration access	enabled	true/false
			port	Number: refer to default settings an possible parameters for constraints.
		bbmd	enabled	true/false
			ipv4Address	xxx.xxx.xxx.xxx
			timeToLive	number of seconds
			servicesEnabled	true/false
		device	deviceld	*
			deviceName	*

		dccPassword	*
--	--	-------------	---

3.7.6.7.1 Additional information



For details on Save and Restore, see the [Save and Restore](#) section.

3.7.7 Certificate

3.7.7.1 Pairing with clients



For details on pairing instructions, follow the link [pairing instructions](#) in the tile or see the [Servicing the Network Management Module](#)>>>[Pairing agent to the Network Module](#) section.

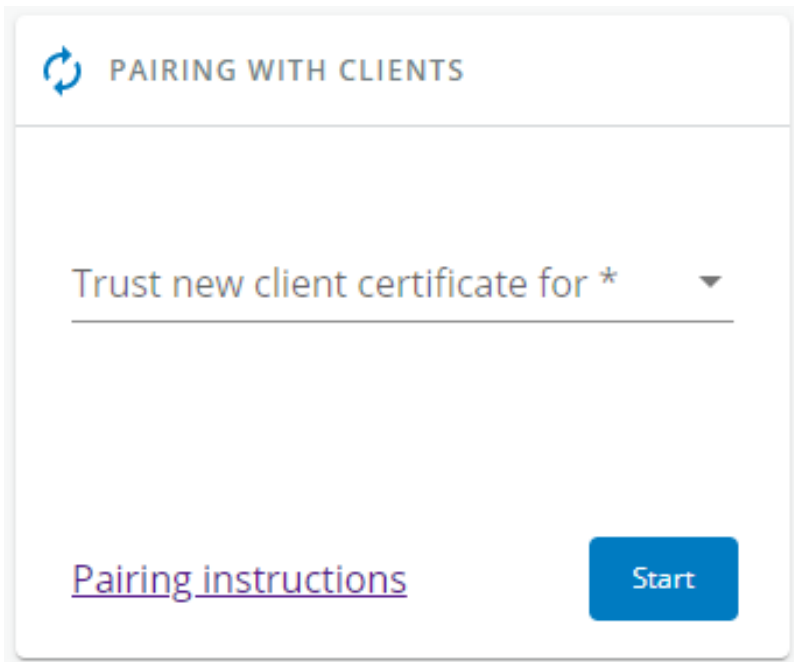

During the selected timeframe, new connections to the Network Module are automatically trusted and accepted.

After automatic acceptance, make sure that all listed clients belong to your infrastructure. If not, access may be revoked using the Delete button.

The use of this automatic acceptance should be restricted to a secured and trusted network.

For maximum security, we recommend following one of the two methods on the certificate settings page:

- Import agent's certificates manually.
- Generate trusted certificate for both agents and Network Module using your own PKI.

3.7.7.1.1 Actions

a Start

Starts the pairing window during the selected timeframe or until it is stopped.

Time countdown is displayed.

b Stop

Stops the pairing window.

Issuer configuration ✕

Country *
FR - France

State or province *
38

City or locality *
Grenoble

Organization name *
Eaton

Organization unit
Power Quality

Contact email address

Modification will take effect at next certificate generation

Cancel Save

- Common name (CN)
- Country (C)
- State or Province (ST)
- City or Locality (L)
- Organization name (O)
- Organization unit (OU)
- Contact email address

Press **Save** button.



Issuer configuration will be applied only after the revoke of the certificate.

d Edit

Press the pen logo:

You will get access to the following:

- Certificate summary
- Actions
 - Generate a new self-signed certificate.
 - Generate CSR.
 - Import certificate (only available when CSR is generated).
- Details

e Generate a new self-signed certificate

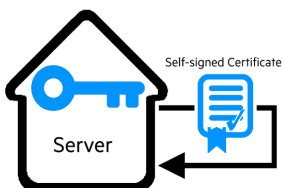

To replace a selected certificate with a new self-signed certificate.

This may disconnect applications such as a Web browser, shutdown application, or monitoring application.

This operation cannot be recovered.

f Create new certificates:

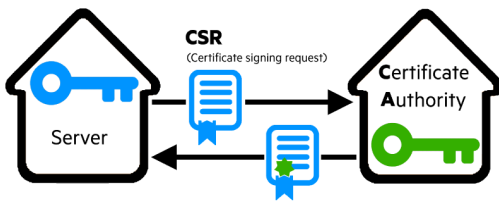

g CSR

Press **Generate Signing Request** button in the in the certificate edition.

The CSR is automatically downloaded.

CSR must be signed with the CA, which is managed outside the card.

h Import certificate

When the CSR is signed by the CA, it can be imported into the Network Module.

When the import is complete, the new local certificate information is displayed in the table.

3.7.7.3 Certificate authorities (CA)

Manages CAs.

3.7.7.3.1 CA table

The screenshot shows a web interface for managing Certificate Authorities (CA). At the top, it says 'CERTIFICATE AUTHORITIES (CA)'. Below this are two buttons: a blue 'Import' button with a plus sign and a grey 'Revoke' button with a circular arrow. Below the buttons is a table with the following columns: 'Used for', 'Issued by', 'Issued To', 'Valid from', 'Expiration', and 'Status'. The table is currently empty, and a red message 'No certificate authorities.' is displayed in the center.

The table displays certificate authorities with the following details:

- Used for
- Issued by
- Issued to
- Valid from
- Expiration
- Status — valid, expires soon, or expired

3.7.7.3.2 Actions

a Import

When importing the CA, you must select the associated service, and then upload process can begin through the OS browser window.

b Revoke

Select the certificate to revoke, and then press the **Revoke** button.

A confirmation window appears, press **Continue** to proceed, this operation cannot be recovered.

Export

Exports the selected certificate on your OS browser window.

c Edit

Press the pen logo to access to the certificate summary: 

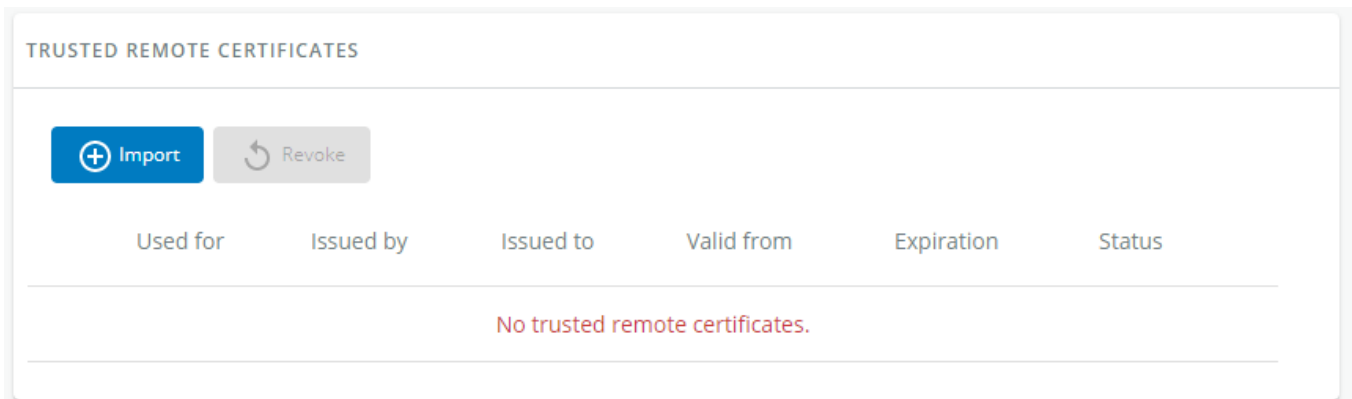
3.7.7.4 Trusted remote certificates

The table shows the following information for each trusted remote certificate.

- Used for
- Issued by
- Issued to
- Valid from
- Expiration
 - In case a certificate expires, the connection with the client will be lost. If this happens, the user will have to recreate the connection and associated certificates.
- Status — valid, expires soon, or expired

3.7.7.4.1 Actions**a Import**

When importing the client certificate, you must select the associated service, and then upload process can begin through the OS browser window.

b Revoke

Select the certificate to revoke, and then press the **Revoke** button.

A confirmation window appears, press **Continue** to proceed, this operation cannot be recovered.

c Edit

Press the pen logo to the certificate summary: 

3.7.7.5 Default settings and possible parameters - Certificate

	Default setting	Possible parameters
Local certificates	Common name — Service + Hostname + selfsigned Country — FR State or Province — 38 City or Locality — Grenoble Organization name — Eaton Organization unit — Power quality Contact email address — blank	Common name — 64 characters maximum Country — Country code State or Province — 64 characters maximum City or Locality — 64 characters maximum Organization name — 64 characters maximum Organization unit — 64 characters maximum Contact email address — 64 characters maximum

3.7.7.5.1 For other settings



For other settings, see the [Information>>>Default settings parameters](#) section.

3.7.7.6 Access rights per profiles

	Administrator	Operator	Viewer
Certificate	✓	✗	✗

3.7.7.6.1 For other access rights



For other access rights, see the [Information>>>Access rights per profiles](#) section.

3.7.7.7 CLI commands

certificates

Description

Allows to manage certificates through the CLI.

Help

```
certificates <target> <action> <service_name>
<target> :
  - local
<action> :
  - print: provides a given certificate detailed information.
  - revoke: revokes a given certificate.
  - export: returns a given certificate contents.
  - import: upload a given certificate for the server CSR. This will replace the
  CSR with the certificate given.
  - csr: get the server CSR contents. This will create the CSR if not already
```

```
existing.
<service_name>: mqtt/syslog/webserver
```

Examples of usage

From a linux host:

print over SSH: sshpass -p \$PASSWORD ssh \$USER@\$CARD_ADDRESS certificates local print \$SERVICE_NAME

revoke over SSH: sshpass -p \$PASSWORD ssh \$USER@\$CARD_ADDRESS certificates local revoke \$SERVICE_NAME

export over SSH: sshpass -p \$PASSWORD ssh \$USER@\$CARD_ADDRESS certificates local export \$SERVICE_NAME

import over SSH: cat \$FILE | sshpass -p \$PASSWORD ssh \$USER@\$CARD_ADDRESS certificates local import \$SERVICE_NAME

csr over SSH: sshpass -p \$PASSWORD ssh \$USER@\$CARD_ADDRESS certificates local csr mqtt

From a Windows host: (plink tools from putty is required)

print over SSH: plink \$USER@\$CARD_ADDRESS -pw \$PASSWORD -batch certificates local print \$SERVICE_NAME

revoke over SSH: plink \$USER@\$CARD_ADDRESS -pw \$PASSWORD -batch certificates local revoke \$SERVICE_NAME

export over SSH: plink \$USER@\$CARD_ADDRESS -pw \$PASSWORD -batch certificates local export \$SERVICE_NAME

import over SSH: type \$FILE | plink \$USER@\$CARD_ADDRESS -pw \$PASSWORD -batch certificates local import \$SERVICE_NAME

csr over SSH: plink \$USER@\$CARD_ADDRESS -pw \$PASSWORD -batch certificates local csr mqtt

Where:

- \$USER is user name (the user shall have administrator profile)
- \$PASSWORD is the user password
- \$PASSPHRASE is any passphrase to encrypt/decrypt sensible data.
- \$CARD_ADDRESS is IP or hostname of the card
- \$FILE is a certificate file
- \$SERVICE_NAME is the name one of the following services : mqtt / syslog / webserver.

3.7.7.7.1 For other CLI commands



See the CLI commands in the [Information>>>CLI](#) section.

3.7.7.8 Troubleshooting

Software is not able to communicate with the Network module

Symptoms

- In the Network Module, in [Contextual help>>>Protection>>>Agent list>>>Agent list table](#) , agent is showing "Lost" as a status.
- In the Network Module, in [Contextual help>>>Settings>>>Certificate>>>Trusted remote certificates](#) , the status of the Protected applications (MQTT) is showing "Not valid yet".
- IPP/IPM shows "The authentication has failed", "The notifications reception encountered error".

Possible cause

The IPP/IPM certificate is not yet valid for the Network Module.

Certificates of IPP/IPM and the Network Module are not matching so that authentication and encryption of connections between the Network Module and the shutdown agents is not working.

Setup

IPP/IPM is started.

Network module is connected to the UPS and to the network.

Action #1

Check if the IPP/IPM certificate validity for the Network Module.

STEP 1: Connect to the Network Module

- On a network computer, launch a supported web browser. The browser window appears.
- In the Address/Location field, enter: <https://xxx.xxx.xxx.xxx/> where xxx.xxx.xxx.xxx is the static IP address of the Network Module.
- The log in screen appears.
- Enter the user name in the User Name field.
- Enter the password in the Password field.
- Click **Login**. The Network Module web interface appears.

STEP 2: Navigate to **Settings/Certificates** page

STEP 3: In the **Trusted remote certificates** section, check the status of the **Protected applications (MQTT)**.

If it is **"Valid"** go to Action#2 STEP 2, if it is **"Not yet valid"**, time of the need to be synchronized with IPP/IPM .

STEP 4: Synchronize the time of the Network Module with IPP/IPM and check that the status of the **Protected applications (MQTT)** is now valid.

Communication will then recover, if not go to Action#2 STEP 2.

Action #2

Pair agent to the Network Module with automatic acceptance (recommended in case the installation is done in a secure and trusted network).



For manual pairing (maximum security), go to [Servicing the Network Management Module>>>Pairing agent to the Network Module](#) section and then go to STEP 2, item 1.

STEP 1: Connect to the Network Module.

- On a network computer, launch a supported web browser. The browser window appears.
- In the Address/Location field, enter: <https://xxx.xxx.xxx.xxx/> where xxx.xxx.xxx.xxx is the static IP address of the Network Module.
- The log in screen appears.
- Enter the user name in the User Name field.
- Enter the password in the Password field.
- Click **Login**. The Network Module web interface appears.

STEP 2: Navigate to **Protection/Agents list** page.

STEP 3: In the **Pairing with shutdown agents** section, select the time to accept new agents and press the **Start** button and **Continue**. During the selected timeframe, new agent connections to the Network Module are automatically trusted and accepted.

STEP 4: **Action on the agent (IPP/IPM)** while the time to accepts new agents is running on the Network Module

Remove the Network module certificate file(s) *.0 that is (are) located in the folder Eaton\IntelligentPowerProtector\configs\tls.

Card wrong timestamp leads to "Full acquisition has failed" error message on Software

Symptoms:

IPP/IPM shows the error message "The full data acquisition has failed" even if the credentials are correct.

Possible cause:

The Network module timestamp is not correct.
Probably the MQTT certificate is not valid at Network module date.

Action:

Set the right date, time and timezone. If possible, use a NTP server, refer to [Contextual help>>>Settings>>>General>>>System details>>>Time & date settings](#) section.

3.7.7.8.1 For other issues



For details on other issues, see the [Troubleshooting](#) section.

3.7.7.9 Save and Restore

	SRR section	Settings	Example
Certificate issuer configuration	certificateSettings	country	String: refer to default settings an possible parameters for constraints.
		state	String: refer to default settings an possible parameters for constraints.
		location	String: refer to default settings an possible parameters for constraints.
		organizationName	String: refer to default settings an possible parameters for constraints.
		organizationUnit	String: refer to default settings an possible parameters for constraints.
		contact	String: refer to default settings an possible parameters for constraints.
Local certificate (mqtt)	mqtt	certificateData	
		ca	*
		trustedClient	*

3.7.7.9.1 Additional information



For details on Save and Restore, see the [Save and Restore](#) section.

3.8 Maintenance

3.8.1 Firmware

3.8.1.1 Update firmware

Update Firmware						
+ Upload						
Status	Version	Sha	Generated On	Installed On	Activated on	
Invalid	1.7.7	aa12be2	03/17/2020	03/17/2020	03/17/2020	
Active	2.0.0	f8d1f71	03/18/2020	03/19/2020	03/19/2020	

- Monitors the information for the two-embedded firmware.
- Upgrade the Network Module firmware.

3.8.1.1.1 Firmware information

a Status

- Uploading
- Invalid
- Valid
- Pending reboot
- Active

b Version/Sha

Displays the associated firmware version and associated Sha.

c Generated on

Displays the release date of the firmware.

For better performance, security, and optimized features, Eaton recommends to upgrade the Network Module regularly.

d Installation on

Displays when the firmware was installed in the Network Module.

e Activated on

Displays when the firmware was activated in the Network Module.

3.8.1.2 Upgrade the Network Module firmware

During the upgrade process, the Network Module does not monitor the Device status.

To upgrade the firmware:

1. Download the latest firmware version from the website. For more information, see the [Servicing the Network Management Module>>>Accessing to the latest Network Module firmware/driver](#) section.
2. Click **+Upload**.
3. Click **Choose file** and select the firmware package by navigating to the folder where you saved the downloaded firmware.
4. Click **Upload**. The upload can take up to 5 minutes.

The firmware that was inactive will be erased by this operation.

When an upgrade is in progress, the upload button is disabled, and the progress elements appear below the table with the following steps:

Transferring > Verifying package > Flashing > Configuring system > Rebooting

A confirmation message displays when the firmware upload is successful, and the Network Module automatically restarts.

Network module is not reachable



Typical reasons: reboot, shutdown, IP address change, port change, certificate regeneration and network disconnect. Please wait for a while and refresh the browser. If problem persists, please contact your system administrator.



Do not close the web browser or interrupt the operation.
Depending on your network configuration, the Network Module may restart with a different IP address. Refresh the browser after the Network module reboot time to get access to the login page. Press F5 or CTRL+F5 to empty the browser to get all the new features displayed on the Web user interface. Communication Lost and Communication recovered may appear in the [Contextual help>>>Alarms](#) section.

3.8.1.3 Access rights per profiles

	Administrator	Operator	Viewer
Firmware	✓	✗	✗

3.8.1.3.1 For other access rights



For other access rights, see the [Information>>>Access rights per profiles](#) section.

3.8.1.4 CLI commands

get release info

Description

Displays certain basic information related to the firmware release.

Help

```
get_release_info
-d Get current release date
-s Get current release sha1
-t Get current release time
-v Get current release version number
```

3.8.1.4.1 For other CLI commands



See the CLI commands in the [Information>>>CLI](#) section.

3.8.1.5 Troubleshooting

The Network Module fails to boot after upgrading the firmware

Possible Cause

- 1- The IP address has changed.
- 2- The Network module LED shows solid red after the upgrade.
- 3- The first boot after the upgrade takes a longer time.

Note: If the application is corrupt, due to an interruption while flashing the firmware for example, the boot will be done on previous firmware.

Action

- 1- Recover the IP address and connect to the card.
- 2- Reset the Network module by using the Restart button on the front panel.
- 3- Wait until the Network module LED shows flashing green.

Refer to [Installing the Network Management Module>>>Accessing the Network Module>>>Finding and setting the IP address](#) section.

Web user interface is not up to date after a FW upgrade

Symptom

After an upgrade:

- The Web interface is not up to date
- New features of the new FW are not displayed
- An infinite spinner is displayed on a tile

Possible causes

The browser is displaying the Web interface through the cache that contains previous FW data.

Action

Empty the cache of your browser using F5 or CTRL+F5.

3.8.1.5.1 For other issues



For details on other issues, see the [Troubleshooting](#) section.

3.8.2 Services

3.8.2.1 Service options

3.8.2.1.1 Sanitization

Sanitization removes all the data; the Network Module will come back to factory default settings.



For details on default settings, see the [Information>>>Default settings parameters](#) section.

To sanitize the Network Module:

1. Click **Sanitize**.

A confirmation message displays, click **Sanitize** to confirm.

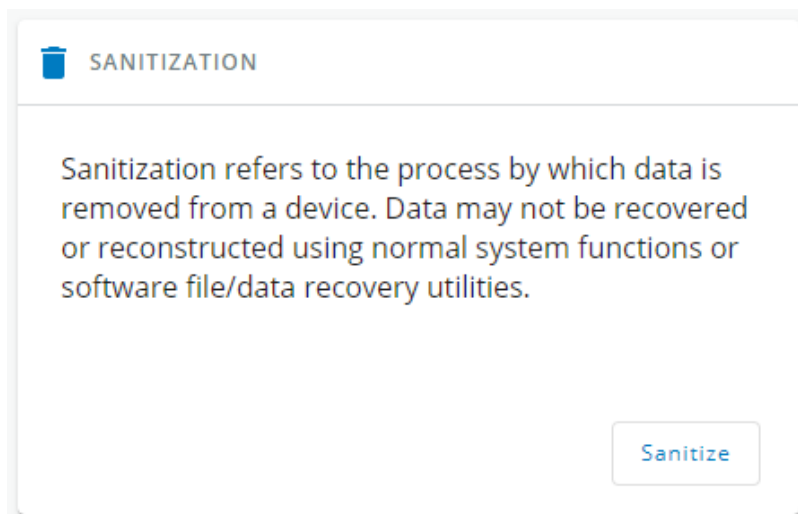

Depending on your network configuration, the Network Module may restart with a different IP address. Only main administrator user will remain with default login and password. Refresh the browser after the Network module reboot time to get access to the login page.

3.8.2.1.2 Reboot

Reboot means restarting the network module operating system.

To reboot the Network Module:

- Click **Reboot**.

A confirmation message displays, click **Reboot** to confirm, the reboot time will take approximately less than 2min.

 REBOOT

Restart the network module operating system

[Reboot](#)

Reboot ✕

The network module will reboot..
Please wait a minute while the network module is restarting.
Note that depending on your configuration the network module may restart with a different IP address.

Please confirm that you wish to continue

[Cancel](#) [Reboot](#)

 Depending on your network configuration, the Network Module may restart with a different IP address. Refresh the browser after the Network module reboot time to get access to the login page. Communication Lost and Communication recovered may appear in the Alarm section.

3.8.2.1.3 Settings

Allow to save and restore the Network module settings.

 For more details, navigate to [Servicing the Network Management Module>>>Saving/Restoring/Duplicating](#) section.

 SETTINGS

Permit to save, reload all module settings.

[Save](#)

The network module will reboot

[Restore](#)

3.8.2.1.4 Save



Below settings are not saved:
Local users other than the main administrator
Sensor settings (commissioning, alarm configuration)

Save Settings



Include Network

Passphrase is required to cipher the sensitive data *

Confirm Passphrase *

Cancel

Save

To save the Network module settings:

1. Click on **Save**
2. Select to include the Network settings if needed.

A passphrase need to be entered twice to cypher the sensitive data.

3. Click on **Save**

3.8.2.1.5 Restore



Restoring settings may result in the Network module reboot.

Restore Settings



This action is not recoverable. The network module will reboot

Include Network

Passphrase *

No file chosen

Cancel

Restore

To restore the Network module settings:

1. Click on **Restore**
2. Select to include the Network settings if needed.
3. Enter the passphrase used when the file was saved.
4. Click on **Choose file** and select the JSON file

5. Click on **Restore** to confirm

3.8.2.1.6 Maintenance

The maintenance report is for the service representative use to diagnose problems with the network module. It is not intended for the user, which is why the file is protected by a password.

To download the maintenance report file:

Click **Download report**.

A confirmation message displays, Maintenance report file successfully downloaded.

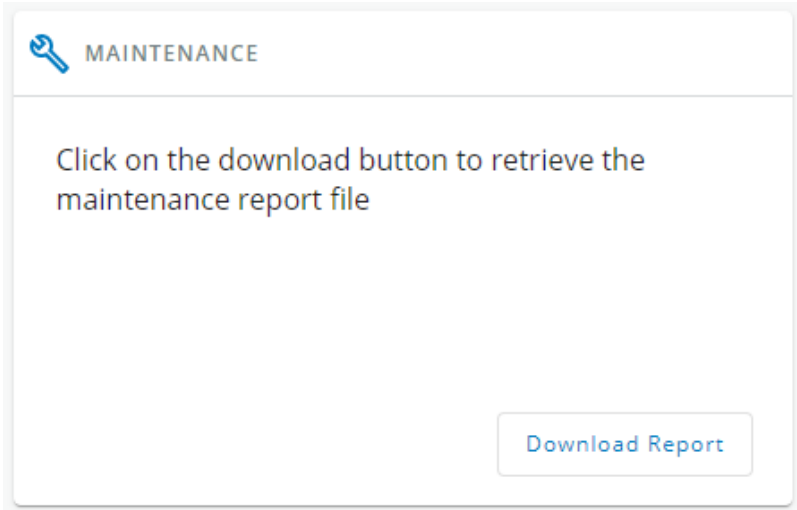

3.8.2.2 Access rights per profiles

	Administrator	Operator	Viewer
Services	✔	✘	✘

3.8.2.2.1 For other access rights

 For other access rights, see the [Information>>>Access rights per profiles](#) section.

3.8.2.3 CLI commands

maintenance

Description

Creates a maintenance report file which may be handed to the technical support.

Help

```

maintenance
  <cr> Create maintenance report file.
  -h, --help Display help page

```

reboot

Description

Tool to Reboot the card.

Help

```

Usage: reboot [OPTION]
  <cr>                Reboot the card
  --help              Display help
  --withoutconfirmation Reboot the card without confirmation

```

save_configuration | restore_configuration

Description

Save_configuration and restore_configuration are using JSON format to save and restore certain part of the configuration of the card.

Help

```

save_configuration -h
save_configuration: print the card configuration in JSON format to standard output.

```

```

restore_configuration -h
restore_configuration: restore the card configuration from a JSON-formatted standard
input.

```

Examples of usage

From a linux host:

Save over SSH: `sshpass -p $PASSWORD ssh $USER@$CARD_ADDRESS save_configuration -p $PASSPHRASE > $FILE`
Restore over SSH: `cat $FILE | sshpass -p $PASSWORD ssh $USER@$CARD_ADDRESS restore_configuration -p $PASSPHRASE`

From a Windows host:

Save over SSH: `plink $USER@$CARD_ADDRESS -pw $PASSWORD -batch save_configuration -p $PASSPHRASE > $FILE`
Restore over SSH: `type $FILE | plink $USER@$CARD_ADDRESS -pw $PASSWORD -batch restore_configuration -p $PASSPHRASE`
 (Require plink tools from putty)

Where:

- \$USER is user name (the user shall have administrator profile)
- \$PASSWORD is the user password
- \$PASSPHRASE is any passphrase to encrypt/decrypt sensible data.
- \$CARD_ADDRESS is IP or hostname of the card
- \$FILE is a path to the JSON file (on your host computer) where the configuration is saved or restored.

sanitize

Description

Sanitize command to return card to factory reset configuration.

Access

- Administrator

Help

```
sanitize
-h, --help           Display help page
--withoutconfirmation Do factory reset of the card without confirmation
<cr>                Do factory reset of the card
```

3.8.2.3.1 For other CLI commands



See the CLI commands in the [Information>>>CLI](#) section.

3.8.3 Resources

Card resources is an overview of the Network Module processor, memory and storage information.

The **COPY TO CLIPBOARD** button will copy the information to your clipboard so that it can be past.

For example, you can copy and paste information into an email.

3.8.3.1 Processor

PROCESSOR	
Used	7.1 %
Up since	03/24/2020 15:32:38

- Used in %
- Up since date

3.8.3.2 Memory

MEMORY	
Total	245 MB
Available	155 MB
Application	90 MB
Temporary files	816 kB

- Total size in MB
- Available size in MB
- Application size in MB
- Temporary files size in MB

3.8.3.3 Storage

STORAGE	
Total	32 MB
Available	28 MB
Used	5 MB

- Total size in MB
- Available size in MB
- Used size in MB

3.8.3.4 Access rights per profiles

	Administrator	Operator	Viewer
Resources	✓	✓	✓

3.8.3.4.1 For other access rights



For other access rights, see the [Information>>>Access rights per profiles](#) section.

3.8.3.5 CLI commands

systeminfo_statistics

Description

Displays the following system information usage:

1. CPU
 - a. usage : %
 - b. upSince : date since the system started
2. Ram
 - a. total: MB
 - b. free: MB
 - c. used: MB
 - d. tmpfs: temporary files usage (MB)
3. Flash
 - a. user data
 - i. total: MB

- ii. free: MB
- iii. used: MB

Help

```
systeminfo_statistics      Display systeminfo statistics
-h, --help                Display the help page.
```

3.8.3.5.1 For other CLI commands



See the CLI commands in the [Information>>>CLI](#) section.





3.8.4 System logs

3.8.4.1 System logs

There are 4 types of logs available:

- Update
- Account
- Session
- System

Select the log files to download and press the download icon: 

SYSTEM LOGS	
Log File name	
system-logs-update.csv	
system-logs-account.csv	
system-logs-session.csv	
system-logs-system.csv	



For the list of system logs, see the [Information>>>System Logs codes](#) section.

3.8.4.2 Access rights per profiles

	Administrator	Operator	Viewer

System logs	✔	✘	✘
-------------	---	---	---

3.8.4.2.1 For other access rights

 For other access rights, see the [Information>>>Access rights per profiles](#) section.

3.8.5 System information

System information is an overview of the main Network Module information.

The **COPY TO CLIPBOARD** button will copy the information to the clipboard.

3.8.5.1 Identification

- System name – if filled, it replaces the Device model name in the top bar
- Product
- Physical name
- Vendor
- UUID
- Part number
- Serial number
- Hardware version
- Location
- Contact
- MAC address

3.8.5.2 Firmware information

- Version
- SHA
- Build date
- Installation date
- Activation date
- Bootloader version

3.8.5.3 Access rights per profiles

	Administrator	Operator	Viewer
System information	✔	✔	✔

3.8.5.3.1 For other access rights

 For other access rights, see the [Information>>>Access rights per profiles](#) section.

3.9 Legal information

This Eaton network module includes software components, which are licensed under various open source licenses, or under a proprietary license.

Availability of source code

Notice for proprietary elements

Component	License
...	...
...	...

This Network Module includes software components that are either licensed under various open source license, or under a proprietary license.

3.9.1 Component

All the open source components included in the Network Module are listed with their licenses.

3.9.2 Availability of source code

Provides the way to obtain the source code of open source components that are made available by their licensors.

Availability of source code
✕

The source code of open source components which are made available by their licensors (including Eaton where applicable) may be obtained upon written express request by contacting: network-m2-opensource@Eaton.com

Eaton reserves the right to charge minimal administrative costs, in compliance with the terms of the underlying open source licenses, when necessary.

3.9.3 Notice for proprietary elements

Provides notice for our proprietary (i.e. non-Open source) elements.

Notice for proprietary elements
✕

Copyright © 2019 Eaton. This software is confidential and licensed under Eaton Proprietary License or End User License Agreement (EPL or EULA). This software is not authorized to be used, duplicated or disclosed to anyone without the prior written permission of Eaton. Limitations, restrictions and exclusions of the Eaton applicable standard terms and conditions, such as its EPL and EULA, apply. The full text of the Eaton EULA is included hereafter:

Legal Information

The Eaton Gigabit Network Card and Eaton Industrial Gateway Card include software components, which are licensed under various open source licenses, or under a proprietary license.

For more detailed information, please refer to the Legal Information link from the main user interface.

3.9.4 Access rights per profiles

	Administrator	Operator	Viewer
Legal information	✓	✓	✓

3.9.4.1 For other access rights



For other access rights, see the [Information>>>Access rights per profiles](#) section.

3.10 Alarms

Alarms

Status: All Export Clear ● 0 active

03/22/2021

▲	● Inactive	09:48:14	EMPTIME02 (BT) - Communication received
▲	● Inactive	09:46:11	EMPTIME02 (BT) - Communication lost

08/11/2020

▲	● Inactive	17:26:08	Source 1 - In range
▲	● Inactive	17:26:08	Source 1 - Frequency in range
▲	● Inactive	17:26:08	Source 1 - Voltage in range
▲	● Inactive	17:26:08	Station JTS 200V 16A - Synchronized sources
▲	● Inactive	17:25:41	Source 1 - Voltage out of range
▲	● Inactive	17:25:41	Source 1 - Frequency out of range
▲	● Inactive	17:25:41	Source 1 - Out of range
▲	● Inactive	17:25:41	Station JTS 200V 16A - Unsynchronized sources

▲ EMPTIME02 (BT) COMMUNICATIONS RECOVERED

#	Code	1200
👁	State	Closed
⏰	Severity	Warning
🕒	Appeared on	09:46:11
🕒	Disappeared on	09:48:14
Advice-		

Item per page 10 | 1 - 10 / 12 | < >

3.10.1 Alarm sorting

Alarms can be sorted by selecting:

- All
- Active only

3.10.2 Active alarm counter



Alarms with a severity set as Good are not taken into account into the counter of active alarms.

3.10.3 Alarm details

All alarms are displayed and sorted by date, with alert level, time, description, and status.

	Info/Warning/Critical logo	Alarm description text
Active	In color	In bold with "Active" label
Opened	In color	
Closed	Greyed	

3.10.4 Alarm paging

The number of alarms per page can be changed (10-15-25-50-100).

When the number of alarms is above the number of alarms per page, the buttons **First**, **Previous** and **Next** appears to allow navigation in the Alarm list.

3.10.5 Export

Press the **Export** button to download the file.

3.10.6 Clear

Clear alarms

Older than *

03/22/2021 10:28:11

Up to severity *

Critical

Cancel Clear

Press the **Clear** button to clear alarms that are older than a specified date and up to a defined severity.

3.10.7 Alarms list with codes

To get access to the Alarm log codes or the System log codes for email subscription, see sections below:

- [System log codes](#)
- [UPS\(HID\) alarm log codes](#)
- [UPS\(XCP\) alarm log codes](#)
- [EMP alarm log codes](#)
- [Network module alarm log codes](#)

3.10.8 Access rights per profiles

	Administrator	Operator	Viewer
Alarm list	✓	✓	✓
Export	✓	✓	✓
Clear	✓	✓	✗

3.10.8.1 For other access rights



For other access rights, see the [Information>>>Access rights per profiles](#) section.

3.11 User profile

3.11.1 Access to the user profile

Press the icon on the top right side of the page to access the user profile window:



This page is in read-only mode when connected through LDAP and it displays the preferences applied to all LDAP users as configured in the [Contextual help>>>Settings>>>Remote users>>>LDAP](#) section.

3.11.2 User profile

The screenshot shows a user profile interface. At the top, the name 'Admin' is displayed. Below it, a grey circular icon represents the user. To the right of the icon, the username 'administrator' is shown in a rounded rectangle, followed by the realm 'Local'. Below the username, there is a blue link with a padlock icon labeled 'Change password'. At the bottom, there are two blue buttons: 'Edit Account' with a pencil icon and 'Log out' with a door icon.

This page displays the current username with its realm (local, remote) and allows to Change passwords, Edit account and Log out.

3.11.2.1 Change password

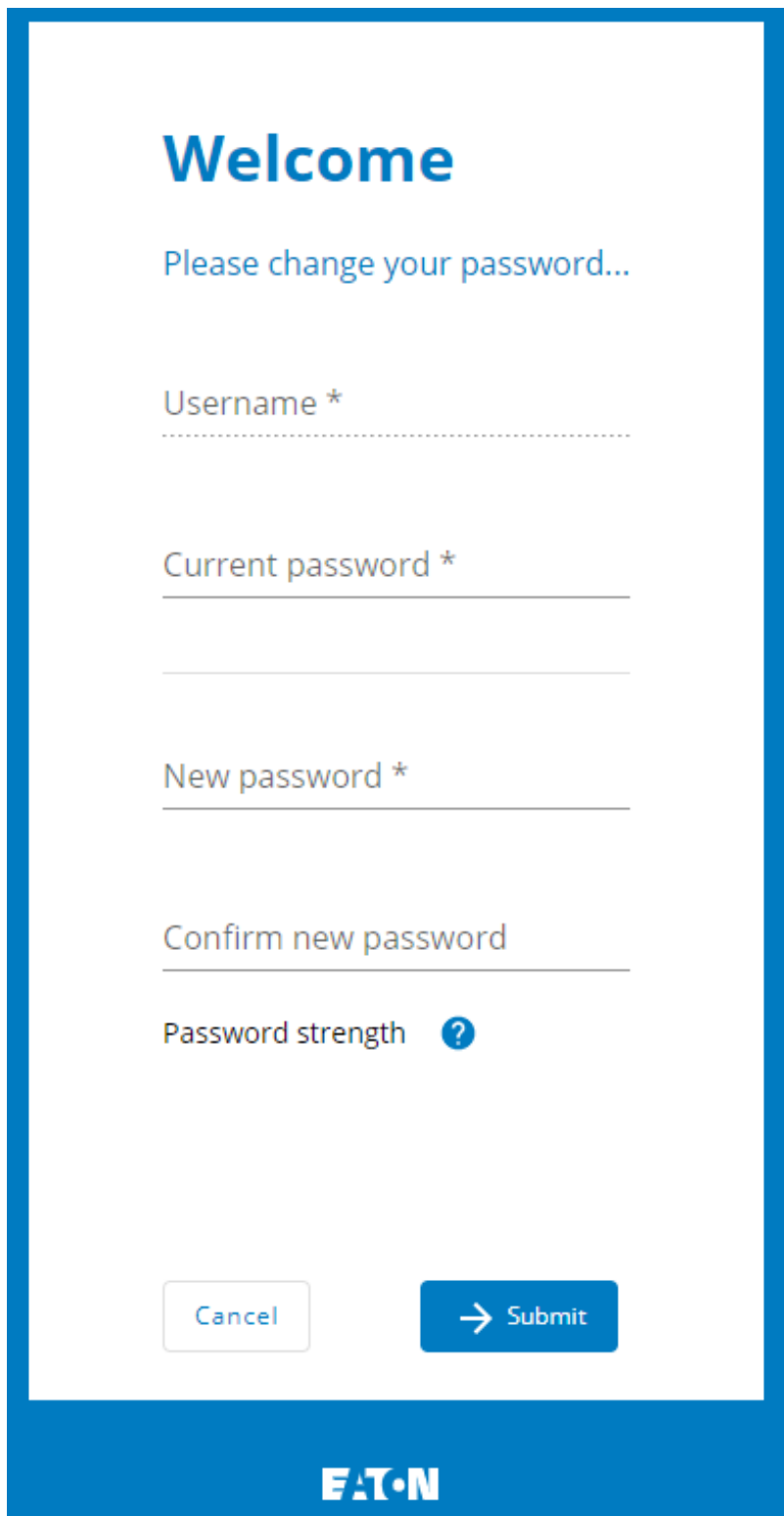

The screenshot shows a 'Change password' form within a blue-bordered container. At the top, the word 'Welcome' is displayed in a large blue font. Below it, the instruction 'Please change your password...' is shown in a smaller blue font. The form contains four input fields: 'Username *' (with a dotted line below), 'Current password *' (with a solid line below), 'New password *' (with a solid line below), and 'Confirm new password' (with a solid line below). Below the input fields is a 'Password strength' indicator with a question mark icon. At the bottom of the form are two buttons: a white 'Cancel' button and a blue 'Submit' button with a right-pointing arrow. The Eaton logo is positioned at the bottom center of the blue container.

Click on **Change password** to change the password.



In some cases, it is not possible to change the password if it has already been changed within a day period. Refer to the troubleshooting section.

3.11.2.2 Edit account

Account Settings
✕

Account Details

Full Name
👤 My name

Email
✉ myName@myCompany.com

Phone
☎ 00 1 256 35 205

Organization
🏢 My company

Preferences

Language
 English

Date Format
 d/m/Y

Time Format
 24h

Temperature
 Celsius

Save

If you have the administrator's rights, you can click on **Edit account** to edit user profile and update the following information:

Account details

- Full name
- Email
- Phone
- Organization

Preferences

- Language
- Date format
- Time format
- Temperature

3.11.2.3 Edit account

Click **Log out** to close the session.

3.11.3 Default settings and possible parameters - User profile

	Default setting	Possible parameters
Profile	Account details: <ul style="list-style-type: none"> • Full name — Administrator • Email — blank • Phone — blank • Organization — blank Preferences: <ul style="list-style-type: none"> • Language — English 	Account details: <ul style="list-style-type: none"> • Full name — 128 characters maximum • Email — 128 characters maximum • Phone — 64 characters maximum • Organization — 128 characters maximum Preferences:

- | | | |
|--|--|--|
| | <ul style="list-style-type: none"> • Date format — MM-DD-YYYY • Time format — hh:mm:ss (24h) • Temperature — °C (Celsius) | <ul style="list-style-type: none"> • Language — English, French, German, Italian, Japanese, Russian, Simplified Chinese, Spanish, Traditional Chinese • Date format — MM-DD-YYYY / YYYY-MM-DD / DD-MM-YYY / DD.MM.YYY / DD/MM/YYYY / DD MM YYYY • Time format — hh:mm:ss (24h) / hh:mm:ss (12h) • Temperature — °C (Celsius)/°F (Fahrenheit) |
|--|--|--|

3.11.3.1 For other settings



For other settings, see the [Information>>>Default settings parameters](#) section.

3.11.4 Access rights per profiles

	Administrator	Operator	Viewer
User profile	✓	✓	✓

3.11.4.1 For other access rights



For other access rights, see the [Information>>>Access rights per profiles](#) section.

3.11.5 CLI commands

logout

Description

Logout the current user.

Help

```
logout
<cr> logout the user
```

whoami

Description

whoami displays current user information:

- Username

- Profile
- Realm

3.11.5.1 For other CLI commands



See the CLI commands in the [Information>>>CLI](#) section.

3.11.6 Troubleshooting

Password change in My profile is not working

Symptoms

The password change shows "*Invalid credentials*" when I try to change my password in My profile menu:



Possible cause

The password has already been changed once within a day period.

Action

Let one day between your last password change and retry.

3.11.6.1 For other issues



For details on other issues, see the [Troubleshooting](#) section.

3.11.7 Save and Restore

	SRR section	Settings	Possible values
Account details	vCard	fullName	String: refer to default settings an possible parameters for constraints.
		email	String: refer to default settings an possible parameters for constraints.
		phone	String: refer to default settings an possible parameters for constraints.
		organization	String: refer to default settings an possible parameters for constraints.

Preferences	preferences	notifyByMail	true/false
		licenseAgreed	true/false
		language	de: Deutsch en: English es: Español fr: Français it: Italiano ja: 日本語 ru: русский zh_Hans: 简体中文 zh_Hant: 繁體中文
		dateFormat	Y-m-d: YYYY-MM-DD d-m-Y: DD-MM-YYYY d.m.Y: DD.MM.YYYY d/m/Y: DD/MM/YYYY m/d/Y: MM/DD/YYYY d m Y: DD MM YYYY
		timeFormat	1: 24h 0: 12h
		temperatureUnit	1: °C 2: °F

3.11.7.1 Additional information



For details on Save and Restore, see the [Save and Restore](#) section.

3.12 Documentation

3.12.1 Access to the embedded documentation

Press the ? icon on the top right side of the page to access the documentation in a new window:



The focus will be made on the contextual page.

You can then navigate into below sections:

Contextual help	Help for each webpage. Extracts from the sections below when they are related to the web page.
Servicing the Network Management Module	How to install and use the Network module.
Securing the Network Management Module	How to secure the Network module.
Information	General information of the Network Module and Devices.

Troubleshooting

How to troubleshoot the Network Module.



Search feature is indexed.

3.12.2 Access rights per profiles

	Administrator	Operator	Viewer
Contextual help	✓	✓	✓
Full documentation	✓	✓	✓

3.12.2.1 For other access rights



For other access rights, see the [Information>>>Access rights per profiles](#) section.

4 Servicing the Network Management Module

4.1 Configuring/Commissioning/Testing LDAP

4.1.1 Commissioning

Refer to the section [Contextual help>>>Settings>>>Local users](#) to get help on the configuration.

4.1.1.1 Configuring connection to LDAP database

This step configures the LDAP client of the network module to request data from an LDAP base.

1. Activate LDAP.
2. Define security parameters according to LDAP servers' requirements.
3. Configure primary server (and optionally a secondary one).
4. If security configuration needs server certificate verification, import your LDAP server certificate.
Refer to the section [Certificate import](#) to get help on certificate import.
 - a. In case LDAP server certificate is self-signed, import the self-signed certificate in the *Trusted remote certificate list for LDAP service*.
 - b. In case LDAP server certificate has been signed by a CA, import the corresponding CA in the *Certificate authorities (CA) list for LDAP service*.
5. Configure credentials to bind with the LDAP server or select *anonymous* if no credentials are required.
6. Configure the *Search base DN*.
7. Configure the request parameters (see examples below).

4.1.1.1.1 Typical request parameters

Parameter	OpenLDAP	Active Directory™ with POSIX account activated	Active Directory™
User base DN	ou=users, dc=example, dc=com	ou=users, dc=example, dc=com	ou=users, dc=example, dc=com
User name attribute	uid	uid	sAMAccountName
UID attribute	uidNumber	uidNumber	objectSid:S-1-5-xx-yy-zz (domain SID)
Group base DN	ou=groups, dc=example, dc=com	ou=groups, dc=example, dc=com	ou=groups, dc=example, dc=com
Group name attribute	gid	gid	sAMAccountName
GID attribute	gidNumber	gidNumber	objectSid:S-1-5-xx-yy-zz (domain SID)

4.1.1.2 Testing connection to LDAP database

Refer to the section [Information>>>CLI>>>ldap-test](#) to get help on the CLI command.

To test connection to the LDAP database:

1. Connect to the CLI.
2. Launch `ldap-test -checkusername` command.
3. In case of error, use the `verbose` option of the command to investigate the reason.

4.1.1.3 Map remote users to profile



This step is mandatory and configures the Network module to give permissions to the LDAP users. Users not belonging to a group mapped on a profile will be rejected.

Configure the rules to mapped LDAP users to profile:

1. Enter LDAP group name.
2. Select the profile to assigned.

You can define up to 5 mapping rules.

All LDAP users belonging to the configured LDAP group will have permissions granted by the associated profile.



If a user belongs to multiple LDAP groups mapped to different profiles, the behavior is undefined.

4.1.1.4 Testing profile mapping

Refer to the section Information>>>CLI>>>ldap-test to get help on the CLI command.

To test LDAP users profile mapping:

1. Connect to the CLI.
2. Launch `ldap-test --checkmappedgroups` command.
3. This command will verify each mapped group exists in the LDAP base and will display the associated local profile.
4. In case of error, use the *verbose* option of the command to investigate the reason.

4.1.1.5 Define LDAP user's preferences

This step configures the user's preferences to apply to **all** LDAP users.

4.1.2 Testing LDAP authentication

Refer to the section Information>>>CLI>>>ldap-test to get help on the CLI command.

1. Connect to the CLI.
2. Launch `ldap-test --checkauth` command.
3. This command will verify an LDAP user can authenticate using his username and password and will display its local profile.
4. In case of error, use the *verbose* option of the command to investigate the reason

4.1.3 Limitations

- If the same username exists in both local and LDAP databases, the behavior is undefined.
- If a user belongs to multiple LDAP groups mapped to different profiles, the behavior is undefined.
- No client certificate provided. It is not possible for the server to verify the client authenticity.
- It is not possible to configure LDAP to work with 2 different search bases.
- LDAP user's preferences are common to all LDAP users.
- LDAP users cannot change their password through the Network Module.
- The remote groupname entered in profile mapping settings must be composed only of alphanumeric, underscore and hyphen characters (but this last one can't be at the beginning).

4.2 Pairing agent to the Network Module

Authentication and encryption of connections between the UPS network module and shutdown agents is based on matching certificates.

4.2.1 Pairing with credentials on the agent

STEP 1: Action on the agent (IPP/IPM).

1. Connect to the web interface of the agent.
2. Detect the UPS Network Module with an **Address(es) scan**, select **Override** global authentication settings and type the UPS Network Module credentials.

4.2.2 Pairing with automatic acceptance (recommended if done in a secure and trusted network)

Pairing with automatic acceptance of shutdown agents and UPS network modules is recommended in case the installation is done in a secure and trusted network, and when certificates cannot be created in other ways.

STEP 1: Action on the Network Module

1. Connect to the Network Module
 - On a network computer, launch a supported web browser. The browser window appears.
 - In the Address/Location field, enter: `https://xxx.xxx.xxx.xxx` where `xxx.xxx.xxx.xxx` is the static IP address of the Network Module.
 - The log in screen appears.
 - Enter the user name in the User Name field.
 - Enter the password in the Password field.
 - Click **Login**. The Network Module web interface appears.
2. Navigate to [Contextual help>>>Protection>>>Agents list](#) page
3. In the **Pairing with shutdown agents** section, select the time to accept new agents and press the **Start** button and the press **Continue**. During the selected timeframe, new agent connections to the Network Module are automatically trusted and accepted.

STEP 2: Action on the agent (IPP) while the time to accepts new agents is running on the Network Module

1. Connect to the web interface of the agent.
2. Detect the UPS Network Module with a **Quick scan**, **Range scan** or an **Address(es) scan**.
3. Right-click on the UPS Network Module when discovered and then **Set as power source**, **Configure** it, and **Save** it.

STEP 3: Action on the Network Module

1. Make sure all listed agents in the card ([Contextual help>>>Protection>>>Agents list](#)) belong to your infrastructure, if not, access may be revoked using the **Delete** button.
2. If the time for pairing still runs, you can stop it. Press **Stop** in the **Pairing with shutdown agents** section.



STEP 1 and **STEP2** can be done either ways.

4.2.3 Pairing with manual acceptance

Manual pairing provides the maximum security.

STEP 1: Action on the agent (IPP)

1. Connect to the web interface of the agent
2. Detect the UPS Network Module with a **Quick scan**, **Range scan** or an **Address(es) scan**.
3. Define the power source

Note: After that stage, the agent creates a client certificate. The power source could show a communication loss since the current client certificate is not trusted by the Network Module.

4. Copy the agent certificate file **client.pem** that is located in the folder `Eaton\IntelligentPowerProtector\configs\tls..`

STEP 2: Action on the Network Module

1. Connect to the Network Module

- On a network computer, launch a supported web browser. The browser window appears.
- In the Address/Location field, enter: https://xxx.xxx.xxx.xxx where xxx.xxx.xxx.xxx is the static IP address of the Network Module.
- The log in screen appears.
- Enter the user name in the User Name field.
- Enter the password in the Password field.
- Click **Login**. The Network Module web interface appears.

2. Navigate to [Contextual help>>>Settings>>>Certificate](#) page

3. In the **Trusted remote certificates** section, click **Import**, select **Protected applications (MQTT)** and then click on **CONTINUE**

4. Select the **client.pem** file previously saved, click **Open**. Communication with the agent is restored.

4.3 Powering down/up applications (examples)

4.3.1 Powering down IT system in a specific order

4.3.1.1 Target

Powering down applications first (when on battery for 30s), database servers next (3min after the applications), and storage last (as late as possible).

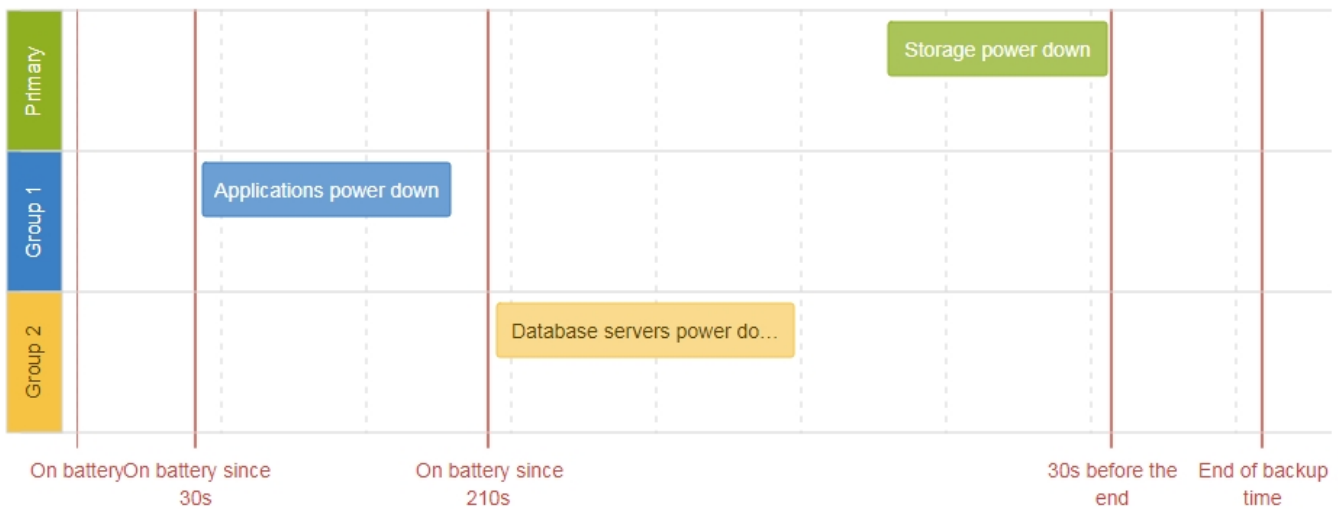

4.3.1.2 Step 1: Installation setup

4.3.1.2.1 Objective

Use load segmentation provided by the UPS to independently control the power supply of each IT equipment categories (Applications, Database servers, Storage).

It also allows IT equipment to sequentially restart on utility recovery ([Restart sequentially the IT equipment on utility recovery](#)).

4.3.1.2.2 Resulting setup

UPS provides outlets (Group 1 and Group 2) and a primary output.



When primary shuts OFF, both group 1 and group 2 shut OFF immediately.

Connections to UPS are done as described below:

- Group 1: Applications
- Group 2: Database servers
- Primary: Storage

4.3.1.3 Step 2: Agent settings

4.3.1.3.1 Objective

Ensure IT solution is shutdown gracefully.

4.3.1.3.2 Resulting setup

1. Install IPP Software on each server (Application, Database servers, Storage) and register the UPS load segment as power source:

- Applications: Group 1
- Database servers: Group 2
- Storage: Entire UPS

2. Pair agent to the Network Module ([Pairing agent to the Network Module](#)).

When done, each server appears in the Agent list.

3. Navigate to [Contextual help>>>Protection>>>Agent shutdown sequencing](#) page.



For examples of Agent settings, see the [Agent shutdown sequencing examples](#) section.

4. Set the OS shutdown duration to the time needed for your server to shutdown gracefully.

This will make sure IPP shutdowns your servers before the load segment is powered down.

As a result, it will define the overall shutdown sequence duration for each load segments.

4.3.1.4 Step 3: Power outage policy settings

4.3.1.4.1 Objective

Use load segment policies to define shutdown sequencing.

4.3.1.4.2 Resulting setup

1. Navigate to [Contextual help>>>Protection>>>Shutdown on power outage](#) page of the Network Module



For examples of Power outage policy, see the following sections:

- [Maximize availability policy example](#)
- [Immediate graceful shutdown policy example](#)
- [Load shedding policy examples](#)
- [Custom policy examples](#)

2. Make sure Primary is set to: **Maximize availability**.

The screenshot shows the configuration for the PRIMARY group. At the top, there is a hamburger menu icon followed by the text 'PRIMARY'. Below this is a section titled 'Select the powering strategy' with a dropdown menu currently set to 'Maximize availability'. Underneath is the heading 'Execution criteria:'. There are three options listed: 1) 'Initiate the sequence when on battery for [] seconds' with an unchecked checkbox. 2) 'Initiate the sequence when the battery is under [] percent' with an unchecked checkbox. 3) 'End [] the sequence 30 seconds before the end of the backup time' with a checked checkbox.

Storage is the last one to power down, its availability is maximized, and its shutdown will end 30s before the end of backup time.

3. Set Group 1 and Group 2 to: **Custom**.

Applications must shutdown first so Group 1 has been set to start shutdown when on battery for 30s.

Servers must shutdown second, so Group 2 has been set to start shutdown when on battery for 210s, so 3min after the applications.

The screenshot shows the configuration for GROUP 1. At the top, there is a hamburger menu icon followed by the text 'GROUP 1'. Below this is a section titled 'Select the powering strategy' with a dropdown menu currently set to 'Custom'. Underneath is the heading 'Execution criteria:'. There are three options listed: 1) 'Initiate the sequence when on battery for 30 seconds' with a checked checkbox. 2) 'Initiate the sequence when the battery is under [] percent' with an unchecked checkbox. 3) 'End [] the sequence [] seconds before the end of the backup time' with an unchecked checkbox.

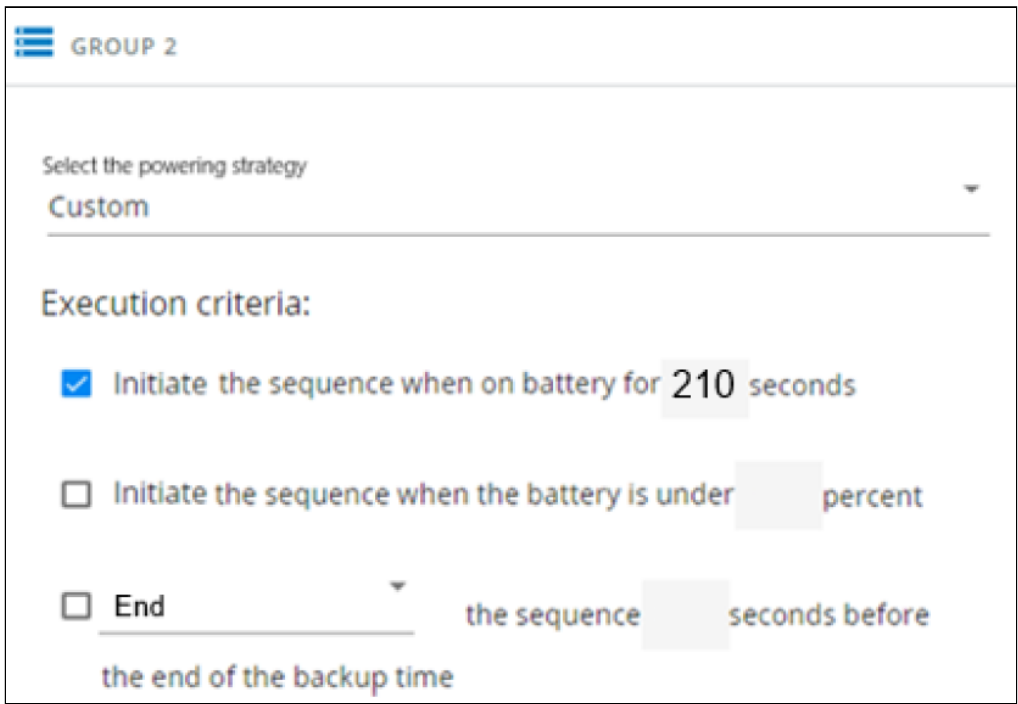

4.3.2 Powering down non-priority equipment first

4.3.2.1 Target

Powering down non-priority equipment first (immediately) and keep battery power for critical equipment.

Powering down critical equipment 3min before the end of backup time.

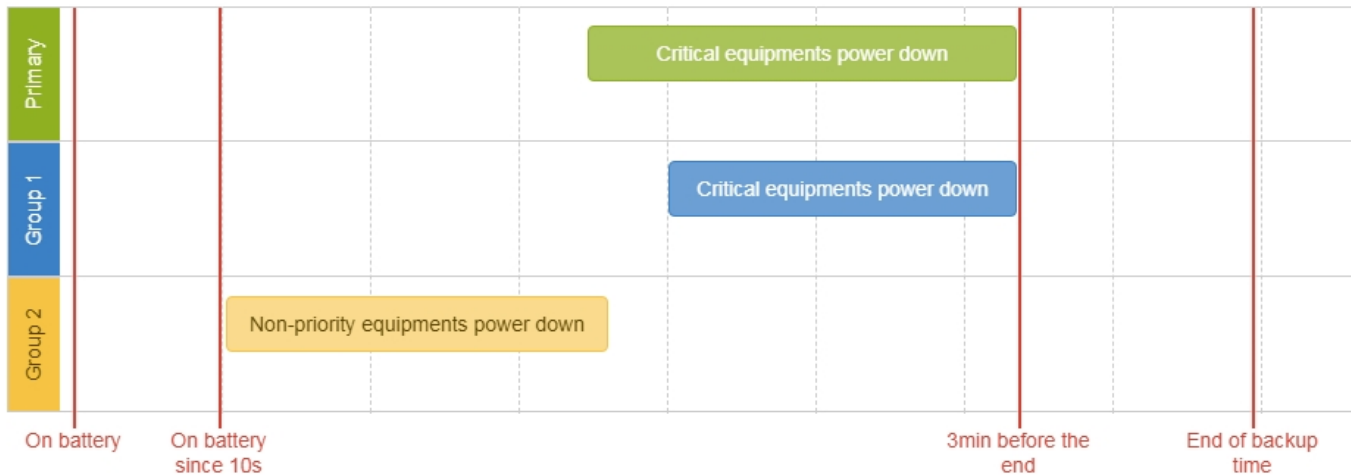

4.3.2.2 Step 1: Installation setup

4.3.2.2.1 Objective

Use load segmentation provided by the UPS to independently control the power supply of each IT equipment categories (Applications, Database servers, Storage).

Load segmentation also allows IT equipment to restart sequentially on utility recovery ([Restart sequentially the IT equipment on utility recovery](#)).

4.3.2.2 Resulting setup

UPS provides outlets (Group 1 and Group 2) and a primary output.



When primary shuts OFF, both group 1 and group 2 shut OFF immediately.

Connections can be done as described below:

- Group 2: non-priority equipment
- Group 1: critical equipment
- Primary: critical equipment

4.3.2.3 Step 2: Agent settings

4.3.2.3.1 Objective

Ensure IT solution is shutdown gracefully.

4.3.2.3.2 Resulting setup

1. Install IPP Software on each server (Application, Database servers, Storage) and register the UPS load segment as power source:
 - Critical equipment: Group 1
 - Non-priority equipment: Group 2
 - Critical equipment: Entire UPS
2. Pair agent to the Network Module ([Pairing agent to the Network Module](#)).
When done, each server appears in the Agent list.
3. Navigate to [Contextual help>>>Protection>>>Agent shutdown sequencing](#) page



For examples of Agent settings, see the [Agents shutdown sequencing](#) sections.

4. Set the OS shutdown duration to the time needed for your server to shutdown gracefully.
This will make sure IPP shutdowns your servers before the load segment is powered down.
As a result, it will define the overall shutdown sequence duration for each load segments.

4.3.2.4 Step 3: Power outage policy settings

4.3.2.4.1 Objective

Use load segment policies to define shutdown sequencing.

4.3.2.4.2 Resulting setup

1. Navigate to [Contextual help>>>Protection>>>Shutdown on power outage](#) page on the Network Module



For examples of Power outage policy, see the following sections:

- [Maximize availability policy example](#)
- [Immediate graceful shutdown policy example](#)
- [Load shedding policy examples](#)
- [Custom policy examples](#)

2. Set Primary and Group 1 to: **Custom** and set it to end shutdown sequence 180s before the end of backup time.

 PRIMARY

Select the powering strategy
 Custom 

Execution criteria:

Initiate the sequence when on battery for seconds

Initiate the sequence when the battery is under percent

End  the sequence seconds before
 the end of the backup time

 GROUP 1

Select the powering strategy
 Custom 

Execution criteria:

Initiate the sequence when on battery for seconds

Initiate the sequence when the battery is under percent

End  the sequence seconds before
 the end of the backup time

Critical equipment is the last one to power down, their availability will be maximized and their shutdown will end 180s before the end of backup time.

- Set Group 2 to: **Immediate off**.

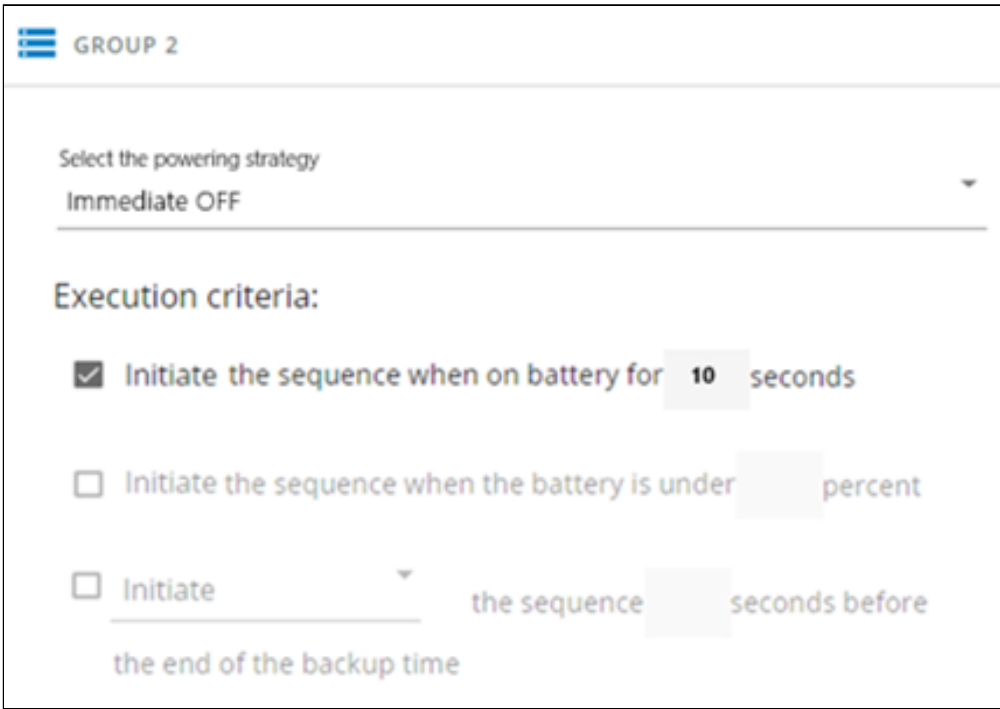

Non-priority equipment immediately shuts down when on battery for 10s to keep battery power for critical equipment.

4.3.3 Restart sequentially the IT equipment on utility recovery

4.3.3.1 Target

Restart the storage first (right after utility recovery), database servers next (2min after utility recovery) and applications last (3min after utility recovery).

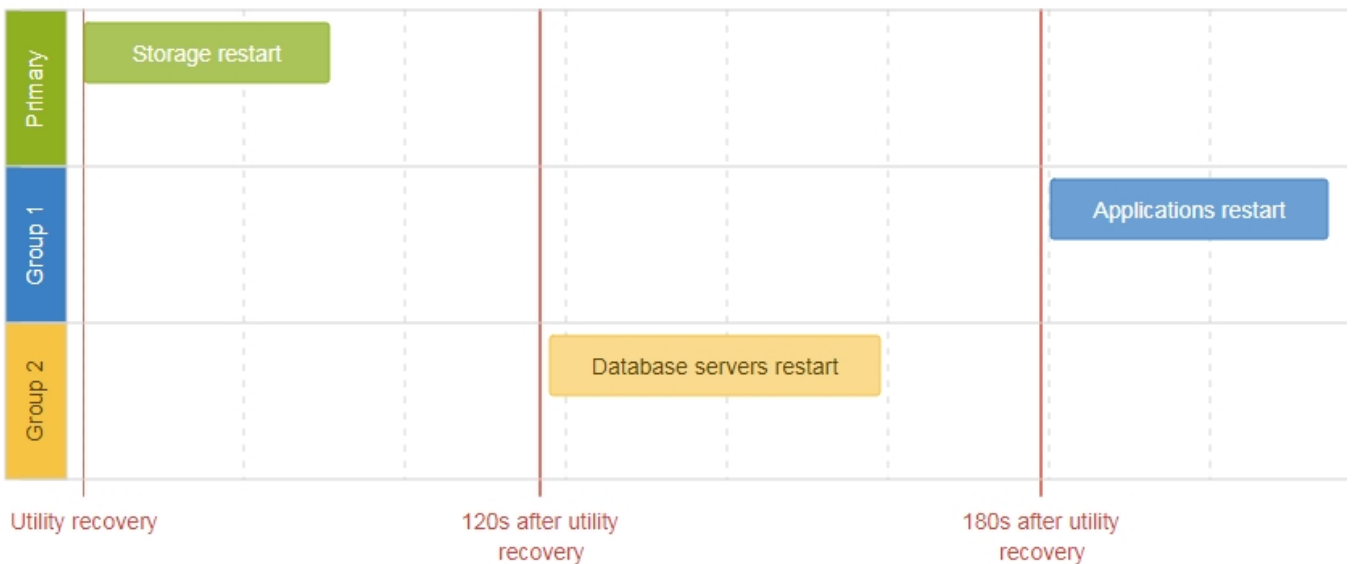

4.3.3.2 Step 1: Installation setup

4.3.3.2.1 Objective

Use load segmentation provided by the UPS to independently control the power supply of each IT equipment categories (Applications, Database servers, Storage).

This will allow to restart sequentially the IT equipment on utility recovery.

4.3.3.2 Resulting setup

UPS provides outlets (Group 1 and Group 2) and a primary output.



When utility recovers, primary starts immediately.

Connections to UPS can be done as described below:

- Group 1: Applications
- Group 2: Database servers
- Primary: Storage

4.3.3.3 Step 2: Power outage policy settings

4.3.3.3.1 Objective

Use load segment restart settings to define restart sequencing.

4.3.3.3.2 Resulting setup

1. Navigate to [Contextual help>>>Protection>>>Shutdown on power outage](#) page and to the **When utility comes back** section.

When utility comes back

Keep shutdown sequence running until the end and then restart (forced reboot)

Automatically restart the UPS when battery capacity exceeds percent

Then Group 1 after seconds

Then Group 2 after seconds

2. Enable the "Keep shutdown sequence running until the end and then restart (forced reboot)".

3. Enable the "Automatically restart the UPS when battery capacity exceeds" and set it to 0%.

The storage will restart first, right after utility recovery without waiting the battery capacity to exceed a % limit.

4. Set Then Group 1 after to 120s.

The database servers will restart 120s after the utility recovery.

5. Set Then Group 2 after to 60s.

The database servers will restart 180s after the utility recovery.

4.4 Checking the current firmware version of the Network Module

Current firmware of the Network Module can be accessed in :

- The Top bar: Firmware version: x.xx.x
- The Card menu : [Contextual help>>>Maintenance>>>System information>>>Firmware information](#): Version x.xx.x
- The Card menu : [Contextual help>>>Maintenance>>>Firmware](#): Active FW version x.xx.x

4.5 Accessing to the latest Network Module firmware/driver/script

Download the latest Network Module firmware, driver or script from the Eaton website www.eaton.com/downloads

4.6 Upgrading the card firmware (Web interface / shell script)



For instructions on accessing to the latest firmware and script, refer to: [Accessing to the latest firmware and script](#)

4.6.1 Web interface

To upgrade the Network module through the Web interface, refer to the section: [Firmware upgrade through the Web interface](#).

4.6.2 Shell script

4.6.2.1 Prerequisite

Shell script uses the following tools: sshpass, scp.

To get it installed on your Linux host, use the following commands.

Debian/Ubuntu

```
$ sudo apt-get install sshpass scp
```

RedHat/Fedora/CentOS

```
$ sudo dnf install sshpass scp
```

Make shell script executable:

```
$ chmod 700 install_updatePackage.sh
```

4.6.2.2 Procedure

To upgrade the Network module using:

1. Open a shell terminal on your computer (Linux or cygwin; meaning real or emulated Linux operating system).
2. Use the shell script *install_updatePackage.sh*

```
Usage: 'install_updatePackage.sh' [options]
Upgrade tool
Mandatory arguments are -f, -i, -u and -p
-h : show help
-f <path> : path of the upgrade file
-u <username> : username of a card user allowed to start upgrade
-p <password> : user password
-i <ipaddress> : ip address of the card to upgrade
-r : reboot the card after upgrade
```

4.6.3 Example:

```
$ ./install_updatePackage.sh -u admin -p <mypassword> -f FW_Update.tar -i <cardIpAddress> -r
```

```
STARTING UPDATE FROM: [FW_Update.tar] to [X.X.X.X]

Transfer by scp (FW_Update.tar) to [X.X.X.X]
Warning: Permanently added 'X.X.X.X' (ECDSA) to the list of known hosts.
Transfer done.
Check running upgrade status ...
Check firmware binary signature
Uncompress and flash upgrade - inProgress():11
Uncompress and flash upgrade - inProgress():28
Uncompress and flash upgrade - inProgress():44
Uncompress and flash upgrade - inProgress():61
Uncompress and flash upgrade - inProgress():78
Uncompress and flash upgrade - inProgress():92
Uncompress and flash upgrade - inProgress():100
Uncompress and flash upgrade - inProgress():100
Uncompress and flash upgrade
Executing post post_upgrade.sh script upgrade
Upgrade done
Warning: Permanently added 'X.X.X.X' (ECDSA) to the list of known hosts.
Rebooting...
res: Y
Update: OK
```

4.7 Changing the RTC battery cell

1. Access the Network Module, and then disconnect the Network cable, if needed.
2. Unscrew the Network Module and remove it from the slot.
3. Locate the RTC battery cell located on the back of the Network Module.

Changing the RTC battery cell

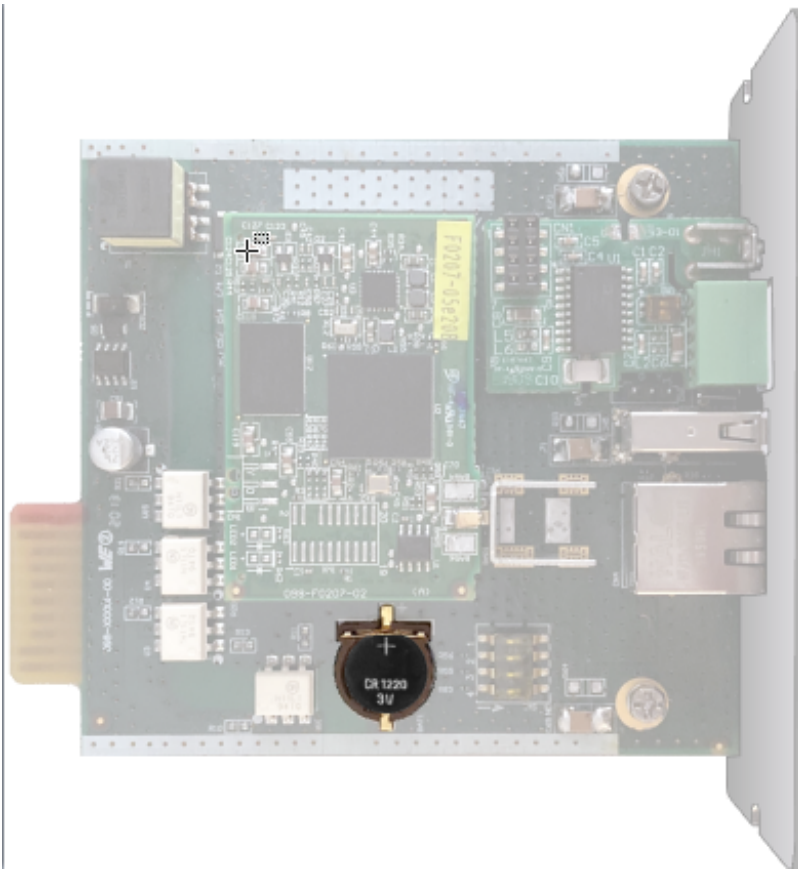

4. Get a new battery cell (CR1220 type).



5. Replace the battery cell, the positive mark (+) should be visible when inserting it.

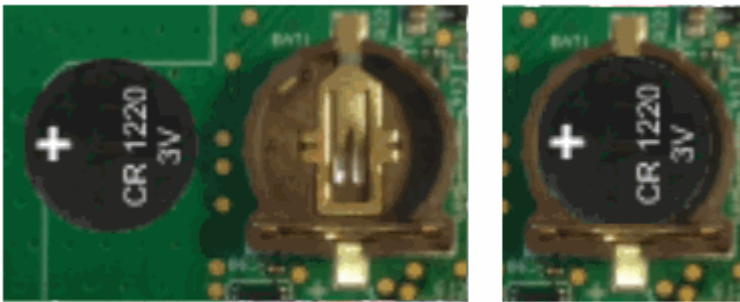

6. Replace the Network Module and secure the screw, reconnect the Network cable if it was unplugged during the operation.

7. Connect the Network Module and set the date and time. For more information, see the Date & Time section.

4.8 Updating the time of the Network Module precisely and permanently (ntp server)

For an accurate and quick update of the RTC for the Network Module, we recommend implementing a NTP server as time source for the Network Module.

LANs have an internal NTP server (Domain Controller, mail servers, Outlook servers are generally time servers too) but you can use a public ntp server like pool.ntp.org (after addition of the related rules to your firewall system).

For more information, see the [Contextual help>>>Settings>>>General>>>System details>>>Time & date settings](#) section.

4.9 Synchronizing the time of the Network Module and the UPS



This section is valid only when the UPS can manage date and time (refer to the UPS user manual for confirmation).



The Network Module use UTC time and manage the time zone and the DST.
The UPS manage only the local time.

4.9.1 Automatic time synchronization

4.9.1.1 Every day at 5 a.m. (UTC time)

The UPS time (local time) is synchronized with the Network Module.

4.9.1.2 If the Network Module time is lost

The Network Module and the UPS time is synchronized with the oldest time between the last know Network Module time and the UPS time.

4.9.2 Manual time synchronization

4.9.2.1 From the Network Module

On the Network Module, navigate to [Contextual help>>>Settings>>>General>>>System details>>>Time & date settings](#) section and update the time.

The UPS time (local time) is directly synchronized with the Network Module.

4.9.2.2 From the UPS



When the time is updated on the UPS, it is not synchronized on the Network Module.

4.10 Changing the language of the web pages

Update the language of the web page in the Settings menu.

1. Navigate to [Contextual help>>>User profile>>>Edit account](#).
2. Select the language, and then press the **Save** button.



The language of the login page is English by default or browser language when it is supported.

4.11 Resetting username and password

4.11.1 As an admin for other users

1. Navigate to [Contextual help>>>Settings>>>Local users](#).
2. Press the pen icon to edit user information: 
3. Change username and **save** the changes.
4. Select **Reset password** and choose from the following options :
 - Generate randomly
 - Enter manually
 - Force password to be changed on next login
5. Enter your own password to confirm the changes.
6. **Save** the changes.

4.11.2 Resetting its own password

1. Navigate to [Contextual help>>>User profile](#).
2. Press [Change password](#)
3. Enter your current password, the new password twice.
4. Press **Submit** to save the changes.

4.12 Recovering main administrator password

To recover the main administrator password, ask another administrator to initialize the password.

If it is not possible, proceed to the card sanitization:



Below instruction will sanitize the card and blank all the data.

Depending on your network configuration, the Network Module may restart with a different IP address.

Only main administrator user will remain with default login and password.

Refresh the browser after the Network module reboot time to get access to the login page.

1. Access the Network Module, disconnect the Network cable, if needed.
2. Unscrew the Network Module and remove it from the slot.
3. Locate the SANITIZATION switch that is located on the back of the Network Module.

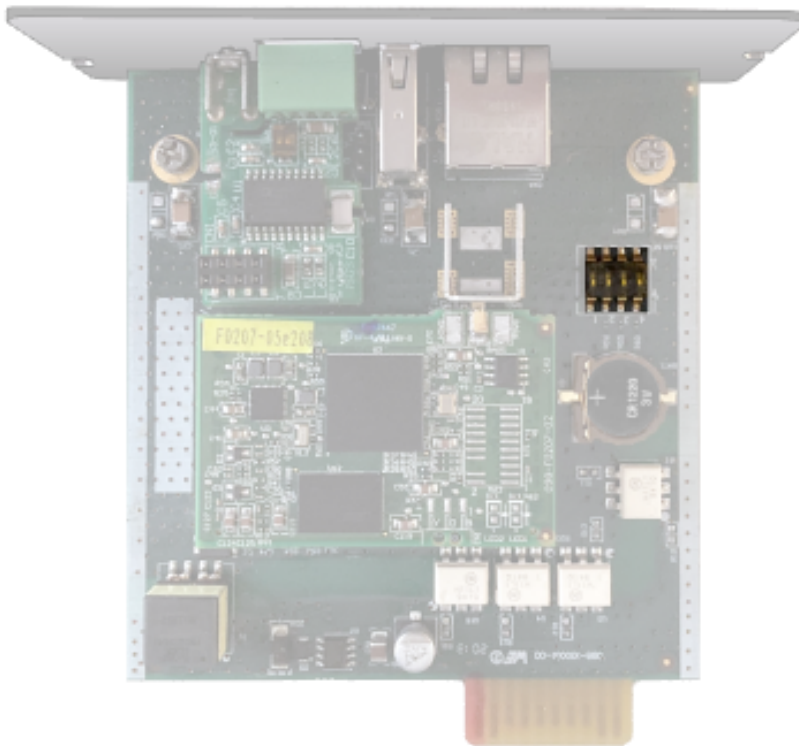

4. Peel off the protection :

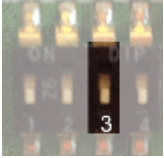
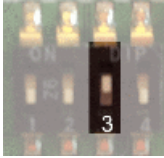
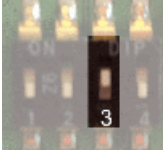
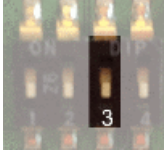

5. Change the position of switch number 3, this change is detected during next power ON and the sanitization will be applied :

Case 1 :		
Case 2 :		



Changes of the switches 1, 2 or 4 has no effect.

6. Replace the Network Module and secure the screw, connect the Network cable, if needed.
7. Connect the Network Module by using the default credentials of the main administrator : admin/admin.
8. You will be forced to change the password accordingly to the current password strength rules.

4.13 Switching to static IP (Manual) / Changing IP address of the Network Module

Administrators can switch to static IP in the Settings menu and change the IP address of the Network Module.

1. Navigate to [Contextual help>>>Settings>>>Network & Protocol>>>IPv4](#).
2. Select Manual (Static IP).
3. Input the following information:
 - IPv4 Address
 - Subnet Mask
 - Default Gateway
4. Save the changes.

4.14 Reading device information in a simple way

4.14.1 Web page

The product information is located in the [Contextual help>>>Home>>>Energy flow diagram>>>Details](#), specifically with the button on the top of the diagram:



4.15 Subscribing to a set of alarms for email notification

4.15.1 Example #1: subscribing only to one alarm (load unprotected)

Follow the steps below:

1. Navigate to [Contextual help>>>Settings>>>General>>>Email notification settings](#).
2. Press the button **New** to create a new configuration.
3. Select:
 - Active: Yes
 - Configuration name: Load unprotected notification
 - Email address: myaddress@mycompany.com
 - Notify on events: Active
 - Always notify events with code: 81E (Load unprotected)



Logs will be attached by default in that example even if there is no subscription on card or device events.

4. Press **Save**, the table will show the new configuration.

	Custom name ↑	Email	Notification updates	Status
<input type="checkbox"/>	Load unprotected notification	myaddress@mycompany.com		Active

4.15.2 Example #2: subscribing to all Critical alarms and some specific Warnings

Follow the steps below:

1. Navigate to [Contextual help>>>Settings>>>General>>>Email notification settings](#).
2. Press the button **New** to create a new configuration.
3. Select:

Subscribing to a set of alarms for email notification

- Active: Yes
- Configuration name: ALL Critical and User account Warning notification
- Email address: myaddress@mycompany.com
- Notify on events: Active
- Subscribe to Critical card events and Critical device events
- Always notify events with code: 0800700, 0800900 (User account - password expired, User account- locked)

Edit email notification settings ✕

Custom name *

Email address *

Status
Active

Schedule report

Recurrence *
Every day

Starting date
09/21/2019 16:56:00

Subscribe	Attach measures	Attach logs	
<input checked="" type="checkbox"/>		<input checked="" type="checkbox"/>	Card Events
<input checked="" type="checkbox"/>	<input type="checkbox"/>	<input checked="" type="checkbox"/>	Device events

Alarm notifications

Subscribe	Attach measures	Attach logs	
<input type="checkbox"/>		<input type="checkbox"/>	All card Events ^
<input checked="" type="checkbox"/>		<input checked="" type="checkbox"/>	Critical alarm
<input type="checkbox"/>		<input type="checkbox"/>	Warning alarm
<input type="checkbox"/>		<input type="checkbox"/>	Info alarm
<input type="checkbox"/>	<input type="checkbox"/>	<input type="checkbox"/>	All device events ^
<input checked="" type="checkbox"/>	<input checked="" type="checkbox"/>	<input checked="" type="checkbox"/>	Critical alarm
<input type="checkbox"/>	<input type="checkbox"/>	<input type="checkbox"/>	Warning alarm
<input type="checkbox"/>	<input type="checkbox"/>	<input type="checkbox"/>	Info alarm

[List of event codes](#)

Always notify events with code

Separate each code with a comma

Never notify events with code

Separate each code with a comma

4. Press **Save**, the table will show the new configuration.

EMAIL NOTIFICATION SETTINGS

+ New
Delete

	Custom name ↑	Email	Notification updates	Status
<input type="checkbox"/>		All critical and User account Warning notification	 <small>Alarms</small>	✔ Active

4.16 Saving/Restoring/Duplicating Network module configuration settings

4.16.1 Modifying the JSON configuration settings file

4.16.1.1 JSON file structure

The JSON file is structured into 3 blocks:

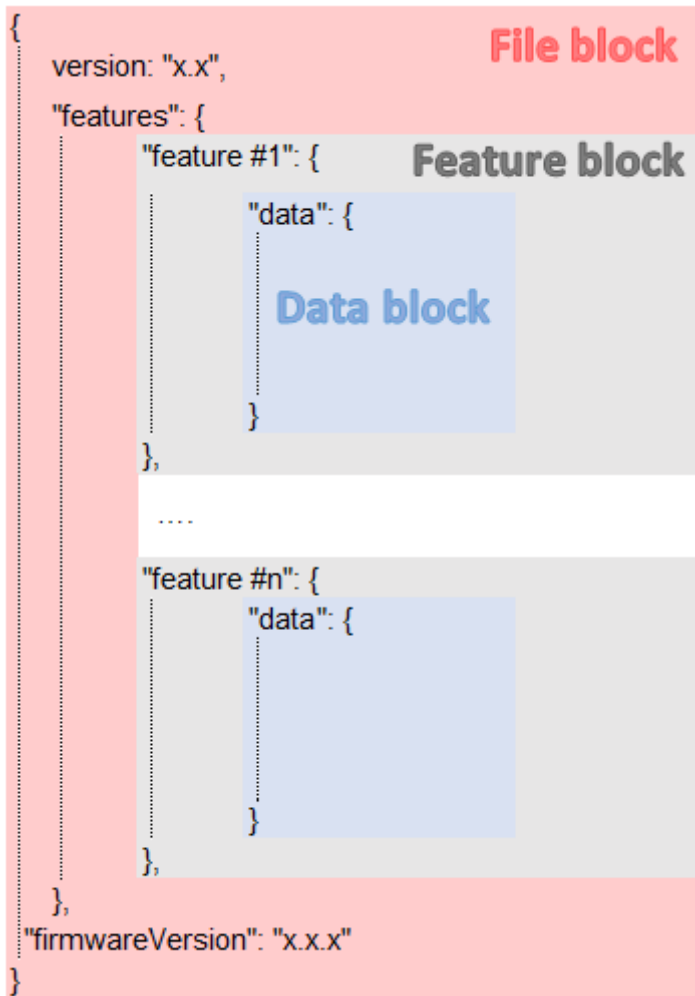

4.16.1.1.1 File block

File block cannot be modified, this is the mandatory structure of the JSON file.

4.16.1.1.2 Feature block

Feature block contains the full definition of a feature.

If it is removed from the JSON file, this feature settings will not be updated/restored in the card.

4.16.1.1.3 Data block

Data block contains all the feature settings values.

```

"data": {
  "version": "x.x",
  "data #1": value,
  "data #2": value,
  "data #3": {
    data #3: value#1,
    data #3: value#2,
    data #3: value#3,
  },
  ....
  "data #n": value,
},
    
```

a Data block

Data block cannot be modified, this is the mandatory structure of the JSON file.

b Value block

If some values inside the Value block need to be kept, Value block structure cannot be modified, this is the mandatory structure of the JSON file.

If it is removed from the JSON file, these values will not be updated/restored.

c Values

Values can be kept as is, modified or removed.

Removed values will not be updated/restored.

4.16.1.2 Sensitive data (like passwords)

JSON file structure will slightly varies if sensitive data are exported with passphrase or not.

4.16.1.2.1 The JSON file is saved using passphrase (preferred)

All sensitive data will have below structure:

```

"password": {
  plaintext: "null",
  cyphered: "p-twlcjoV-a8FjMjkagL6w"
},
    
```



When restoring the file, the corresponding setting will be updated based on the cyphered value.

4.16.1.2.2 The JSON file is saved without passphrase

All sensitive data will have below structure:

```
"password": {
  plaintext: "null",
},
```



When restoring the file, the corresponding setting will not be set. This may lead to restoration failure if corresponding setting was not previously set with a valid value.

4.16.1.3 Modifying JSON file examples

4.16.1.3.1 Modifying sensitive data

To change sensitive data, plain text must be filled with the new value **and the Cyphered entry (if existing) must be removed:**

```
"password": {
  plaintext: "New password",
},
```

4.16.1.3.2 Adding local users

Adding or modifying local users is not yet available, only the predefined account (main administrator) can be modified.

4.16.1.3.3 Modifying SNMP settings

Original file:	Modified file:
SNMP disabled	SNMP enabled on port 161 SNMPv1 disabled SNMPv3 enabled 2 x accounts 1 x read only user (enabled) with Auth-Priv security level and passwords 1x read write user (enabled) with Auth-Priv security level and passwords 1 x active trap

Original file:	Modified file:
<pre> snmp: { data: { version: "x.x", dmeData: { enabled: false, port: xxxx, v1: { enabled: false, communities: { } }, v3: { enabled: false, users: [.....] }, traps: { receivers: [] } } } } } </pre>	<pre> snmp: { data: { version: "x.x", dmeData: { enabled: true, port: 161, v1: { enabled: false, communities: { } }, v3: { enabled: true, users: [{ name: "readonly", allowWrite: false, enabled: true, auth: { enabled: true, password: { plaintext: xxxxxxxxxxxxxx } }, priv: { enabled: true, password: { plaintext: yyyyyyyyyyyyyyy } } }, { name: "readwrite", allowWrite: true, enabled: true, auth: { enabled: true, password: { plaintext: zzzzzzzzzzzzzzzzzzz } }, priv: { enabled: true, password: { plaintext: wwwwwwwwww } } }] }, traps: { receivers: [{ name: "xxxxxxx", host: "xxx.xx.xxx.xx", port: xxx, community: "xxxxx", protocol: x, user: "", enabled: xxxx }] } } } } </pre>

4.16.1.3.4 Making a partial update/restoration

a Example: Updating/Restoring only LDAP settings

If you restore below JSON content, only LDAP settings will be updated/restored, everything else will remain unchanged.

```

{
  "version": "x.x",
  "features": {

```

```

"ldap": {
  "data": {
    "version": "x.x",
    "certificateData": [],
    "dmeData": {
      "enabled": true,
      "baseAccess": {
        "security": {"ssl": 1,"verifyTlsCert": false},
        "primary": {"name": "Primary","hostname": "xxxxxxxxx","port": xxxx},
        "secondary": {"name": "xxxxxx","hostname": "xxxxxx","port": xxxx},
        "credentials": {
          "anonymousSearchBind": false,
          "searchUserDN":
            "CN=xxxx,OU=xxxx,OU=xxxx,OU=xxxx,DC=xxxx,DC=xxxx",
          "password": {"plaintext": null}},
        "searchBase": {"searchBaseDN": "DC=xxx,DC=xxx,DC=xxx"}
      },
      "requestParameters": {
        "userBaseDN": "OU=xxxx,DC=xxxx",
        "userNameAttribute": "xxxx",
        "uidAttribute": "objectSid:x-x-x-xx-xxxxxxxxxxx-xxxxxxxxxxx-xxxxxxxxxxx",
        "groupBaseDN": "OU=xxxx,DC=xxxx",
        "groupNameAttribute": "xx",
        "gidAttribute": "objectSid:x-x-x-xx-xxxxxxxxxxx-xxxxxxxxxxx-xxxxxxxxxxx"
      },
      "profileMapping": [
        { "remoteGroup": "xxxxxxxxxxxxxxxx", "profile": 1},
        { "remoteGroup": "xxxxxxxxxxxxxxxx", "profile": 2},
        { "remoteGroup": "", "profile": 0},
        { "remoteGroup": "", "profile": 0},
        { "remoteGroup": "", "profile": 0}
      ]
    }
  },
  },
  "firmwareVersion": "x.x.x"
}

```

4.16.2 Saving/Restoring/Duplicating settings through the CLI

Navigate to [Information>>>CLI>>>save_configuration | restore_configuration](#) section to get example on how to save and restore settings through the CLI.

4.16.3 Saving/Restoring/Duplicating settings through the Web interface

Navigate to [Contextual help>>>Maintenance>>>Services](#) section to get information on how to save and restore settings through the Web interface.

5 Securing the Network Management Module

5.1 Cybersecurity considerations for electrical distribution systems

5.1.1 Purpose

The purpose of this section is to provide high-level guidance to help customers across industries and applications apply Eaton solutions for power management of electrical systems in accordance with current cybersecurity standards.

This document is intended to provide an overview of key security features and practices to consider in order to meet industry recommended standards and best practices.

5.1.2 Introduction

Every day, cyber-attacks against government and commercial computer networks number in the millions. According to U.S. Cyber Command, Pentagon systems are probed 250,000 times per hour. Similar attacks are becoming more prevalent on other kinds of information-based smart networks as well, such as those that operate buildings and utility systems. Whether the objective is to steal intellectual property or halt operations, the tools and the techniques used for unauthorized network access are increasingly sophisticated.

5.1.3 Connectivity—why do we need to address cybersecurity for industrial control systems (ICS)?

There is increasing concern regarding cybersecurity across industries where companies are steadily integrating field devices into enterprise-wide information systems. This occurs in discrete manufacturing and process industrial environments, a wide range of general and specific purpose commercial buildings, and even utility networks. Traditionally, electrical systems were controlled through serial devices connected to computers via dedicated transceivers with proprietary protocols. In contrast, today's control systems are increasingly connected to larger enterprise networks, which can expose these systems to similar vulnerabilities that are typically found in computer systems. The differences between information technology (IT) and ICS networks can be summarized as follows:

- The main focus of the IT network is to ensure the **confidentiality** and the **integrity** of the data using rigorous access control and data encryption
- The main focus of the ICS network is **safety, availability, and integrity** of data
- Enterprise security protects the servers' data from attack
- Control system security protects the facility's ability to safely and securely operate, regardless of what may befall the rest of the network

5.1.4 Cybersecurity threat vectors

Cybersecurity threat vectors are paths or tools that an entity can use to gain access to a device or a control network in order to deliver a malicious attack. Figure below shows examples of attack vectors on a network that might otherwise seem secure.

5.1.4.1 Paths to the control network

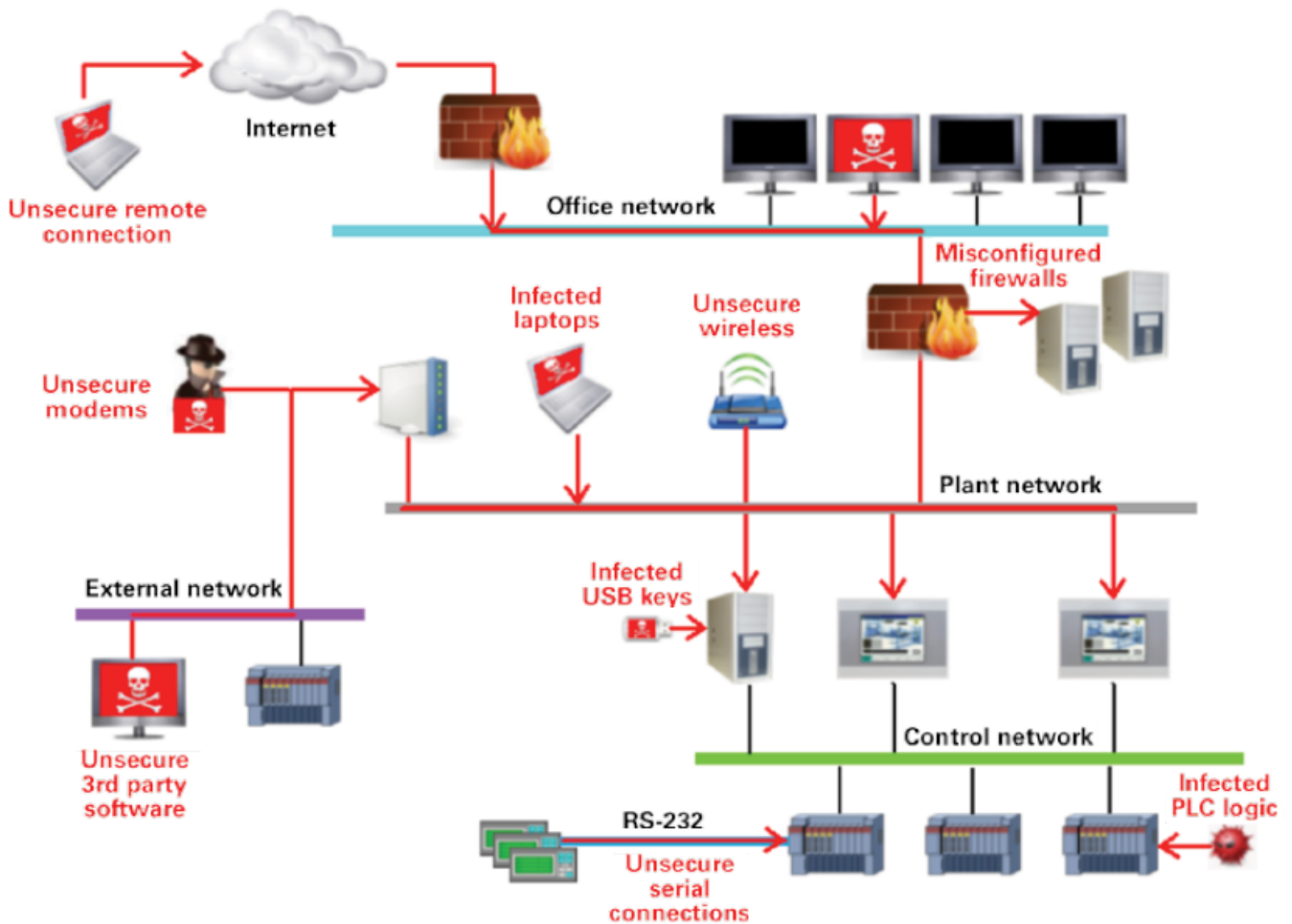

The paths in above figure include:

- External users accessing the network through the Internet
- Misconfigured firewalls
- Unsecure wireless routers and wired modems
- Infected laptops located elsewhere that can access the network behind the firewall
- Infected USB keys and PLC logic programs
- Unsecure RS-232 serial links

The most common malicious attacks come in the following forms:

- Virus—a software program that spreads from one device to another, affecting operation
- Trojan horse—a malicious device program that hides inside other programs and provides access to that device
- Worm—a device program that spreads without user interaction and affects the stability and performance of the ICS network
- Spyware—a device program that changes the configuration of a device

5.1.5 Defense in depth

While there are differences between traditional IT systems and ICS, the fundamental concept of “defense in depth” is applicable to both. Defense in depth is a strategy of integrating technology, people, and operations capabilities to establish variable barriers across multiple layers of an organization. These barriers include electronic countermeasures such as firewalls, intrusion detection software/components, and antivirus software, coupled with physical protection policies and training. Fundamentally, the barriers are intended to reduce the probability of attacks on the network and provide mechanisms to detect “intruders.”

5.1.6 Designing for the threat vectors

5.1.6.1 Firewalls

Firewalls provide the capability to add stringent and multifaceted rules for communication between various network segments and zones in an ICS network. They can be configured to block data from certain segments, while allowing the relevant and necessary data through. A thorough understanding of the devices, applications, and services that are in a network will guide the appropriate deployment and configuration of firewalls in a network. Typical types of firewalls that can be deployed in a network include:

- **Packet filter or boundary firewalls that work on the network layer**
These firewalls mainly operate at the network layer, using pre-established rules based on port numbers and protocols to analyze the packets going into or out of a separated network.
These firewalls either permit or deny passage based on these rules.
- **Host firewalls**
These firewalls are software firewall solutions that protect ports and services on devices. Host firewalls can apply rules that track, allow, or deny incoming and outgoing traffic on the device and are mainly found on mobile devices, laptops, and desktops that can be easily connected to an ICS.
- **Application-level proxy firewalls**
These firewalls are highly secure firewall protection methods that hide and protect individual devices and computers in a control network. These firewalls communicate at the application layer and can provide better inspection capabilities. Because they collect extensive log data, application-level proxy firewalls can negatively impact the performance of an ICS network.
- **Stateful inspection firewalls**
These firewalls work at the network, session, and application layers of the open system interconnection (OSI). Stateful inspection firewalls are more secure than packet filter firewalls because they only allow packets belonging to allowed sessions.
These firewalls can authenticate users when a session is established and analyze a packet to determine whether they contain the expected payload type or enforce constraints at the application layer.
- **SCADA hardware firewalls**
These are hardware-based firewalls that provide defense for an ICS based on observing abnormal behavior on a device within the control network. For example, if an operator station computer suddenly attempts to program a PLC, this activity could be blocked and an alarm could be raised to prevent serious risk to the system.

5.1.6.2 Demilitarized zones (DMZ)

Network segmentation is a key consideration in establishing secure control networks. Firewalls should be used to create DMZ by grouping critical components and isolating them from the traditional business IT network. A three-tier architecture should be employed at a minimum, with a DMZ between the organization's core network and an isolated control system's network as shown in below figure.

5.1.6.2.1 Three-tier architecture for a secure control network

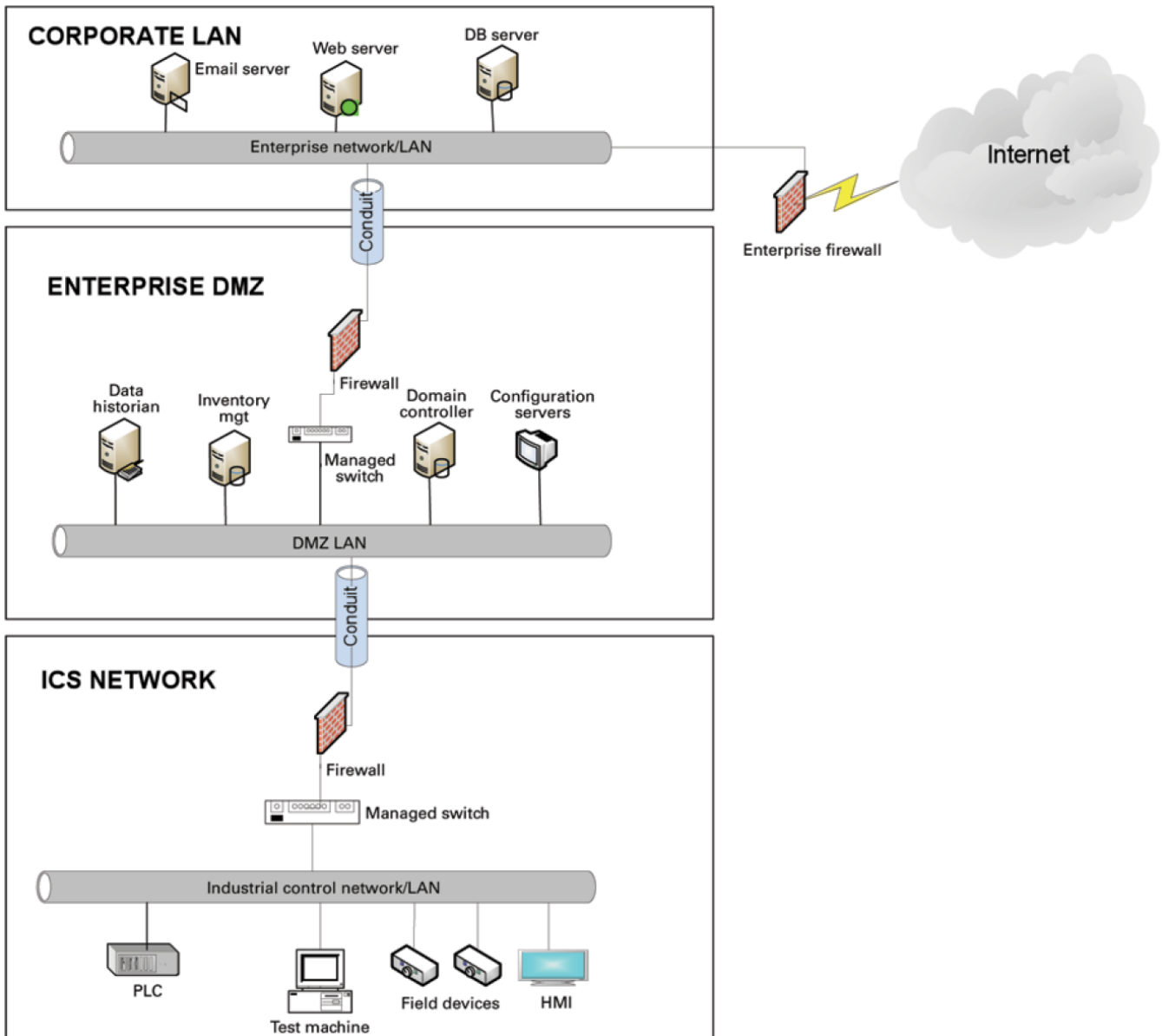

Above figure shows that the control networks are divided into layers or zones based on control functions, which are then connected by conduits (connections between the zones) that provide security controls to:

- Control access to zones
- Resist denial of services (DOS) attacks or the transfer of malware
- Shield other network systems
- Protect the integrity and the confidentiality of network traffic

Beyond network segmentation, access control (both physical and logical) should be defined and implemented.

The key consideration when designing access control is defining the **required** interactions both within a given zone and between zones. These interactions should be mapped out clearly and prioritized based on need. It is important to realize that every hole poked in a firewall and each non-essential functionality that provides access or creates additional connectivity increases potential exposure to attacks. A system then becomes only as secure as the devices connecting to it.

If mapped correctly, the potential adverse impact to control system reliability and functionality should be negligible. However, this element introduces additional costs (in terms of firewall and other network infrastructure) and complexity to the environment.

5.1.6.3 Intrusion detection and prevention systems (IDPS)

These are systems that are primarily focused on identifying possible incidents in an ICS network, logging the information about them, attempting to stop them, and reporting them to ICS security administrators.

Because these systems are critical in an ICS network, they are regular targets for attacks and securing them is extremely important.

The type of IDPS technology deployed will vary with the type of events that need to be monitored.

There are four classes of IDPS technology:

- Network-based IDPS monitors network traffic for particular ICS network segments or devices and analyzes the network and application protocol activity to identify suspicious activity
- Wireless IDPS monitors and analyzes wireless network traffic to identify suspicious activity involving the ICS wireless network protocol
- Network behavior analysis IDPS examines ICS network traffic to identify threats that generate unusual traffic flows such as DOS attacks
- Host-based IDPS monitors the characteristics and the events occurring within a single ICS network host for suspicious activity

5.1.7 Policies, procedures, standards, and guidelines

For the defense in depth strategy to succeed, there must be well-documented and continuously reviewed policies, procedures, standards, and guidelines.

- **Policies** provide procedures or actions that must be carried out to meet objectives and to address the who, what, and why
- **Procedures** provide detailed steps to follow for operations and to address the how, where, and when
- **Standards** typically refer to specific hardware and software, and specify uniform use and implementation of specific technologies or parameters
- **Guidelines** provide recommendations on a method to implement the policies, procedures, and standards

5.1.7.1 Understanding an ICS network

Creating an inventory of all the devices, applications, and services that are hosted in a network can establish an initial baseline for what to monitor. Once those components are identified and understood, control, ownership, and operational consideration can be developed.

5.1.7.2 Log and event management

It is important to understand what is happening within the network from both a performance and security perspective. This is especially true in a control systems environment.

Log and event management entails monitoring infrastructure components such as routers, firewalls, and IDS/IPS, as well as host assets. Security Information and Event Management (SIEM) systems can collect events from various sources and provide correlation and alerts.

Generating and collecting events, or even implementing a SIEM is not sufficient by itself. Many organizations have SIEM solutions, but alerts go unwatched or unnoticed.

Monitoring includes both the capability to monitor environments and the capacity to perform the monitoring. Capability relates to the design and the architecture of the environment. Has it been built in a manner that takes into consideration the ability to monitor? Capacity speaks to the resources (personnel, tools, expertise) needed to perform meaningful interpretation of the information and initiate timely and appropriate action.

Through monitoring, the organization can identify issues such as suspicious or malicious activities. Awareness can be raised when new (potentially unauthorized) devices appear in the environment. Careful consideration should be taken into account to ensure that log and event management does not adversely impact the functionality or the reliability of the control system devices.

5.1.7.3 Security policy and procedures

It is important to identify "asset owners," and to develop policies and procedures for a cybersecurity program. These policies need to be practical and enforceable in order to be effective. Policies should also address access related issues, such as physical access, contractors, and vendors.

Existing (traditional) IT standards and policies may not apply (or have not been considered) for control systems. A gap analysis should be performed to determine which components are not covered (or not adequately covered) by existing policies. Relationships with existing policies and standards should be explicitly identified and new or supporting policies should be developed. It is important that industrial control system administrators have proper authorizations and full support of their management to implement policies that will help secure the ICS network.

5.1.7.4 ICS hardening

The goal for system hardening is to reduce as many security risks as possible by securely configuring ICS networks. The idea is to establish configurations based on what is required and eliminate unnecessary services and applications that could potentially provide another possible entry point to an intruder.

Minimum security baselines should be established for the various platforms and products deployed (operating system, application, and infrastructure elements such as drives, meters, HMI devices). The following actions should be implemented where applicable:

- Disable unnecessary services
- Disable anonymous FTP
- Do not use clear text protocols (e.g., use SSH v2 instead of Telnet)
- Install only required packages/applications/features
- Deploy antivirus solutions (where possible)
- Disable or otherwise control use of USB devices
- Establish a warning banner
- Change default passwords (e.g., SNMP)

It may be easier to implement these actions on devices for which you control the base operating system platform. However, several of the items listed above can be configured from the product specific configuration options.

Changes such as these could potentially impact the functionality of a control system device. Extensive testing needs to be conducted before deployment to minimize this impact.

5.1.7.5 Continuous assessment and security training

It is critical that ICS network administrators and regular users be properly trained to ensure the security of the ICS and the safety of the people who operate and depend on it.

Ongoing vulnerability assessments are critical to identify issues and understand the effectiveness of other defensible network elements.

Assessments should include testing and validating the following:

- Monitoring capabilities and alerts are triggered and responded to as expected
- Device configuration of services and applications
- Expected connectivity within and between zones
- Existence of previously unknown vulnerabilities in the environment
- Effectiveness of patching

A program should be established for performing assessments.

The actual assessment should be performed by a qualified resource, which can be an in-house or third-party organization. Regardless of who performs the assessments, in-house resources need to be involved in the planning, scoping, and supporting of assessment activities and must be appropriately trained to do so.

Assessments should be conducted according to a methodology that is clearly defined to address:

- Physical security
- People and processes
- Network security
- Host security
- Applications security (both internally developed and commercially off-the-shelf (COTS))

5.1.7.6 Patch management planning and procedures

A patching and vulnerability management process should be established based on the timely awareness of issues and appropriate action. This process should take all of the elements that make up the control system environment into consideration.

Information resources should be identified for vulnerability and advisory information for the various components in the environment. These should include vendor-specific sources as well as other public or commercial services that provide vulnerability advisory information. For example, the National Vulnerability Database (NVD) provides information related to vulnerabilities identified in

general IT components, while the Industrial Control Systems Cyber Emergency Response Team (ICS-CERT) publishes advisories specific to control systems.

A regular patch deployment schedule should be established for each component in the environment. Depending on the component, this could range from a monthly schedule to an as-needed deployment, depending on the historical frequency of patch or vulnerability related issues for the component or the vendor. Additionally, out-of-band or emergency patch management needs to be considered and qualifications need to be defined.

Vulnerability information and advisories should be reviewed regularly and assessments should be performed to determine the relative severity and urgency of issues.

Elements of the process should also include the preparation, scheduling, and change controls; testing and rollback procedures; and pre-deployment notification to stakeholders that includes scope, expectations, and reporting. Testing is a significant element, as the effect of the patch application needs to be clearly understood; unintended or unexpected impacts to a control system component influence the decision to deploy a patch. In the event that it is determined that a patch cannot be safely deployed but the severity of the issue represents a significant concern, compensating controls should be investigated.

5.1.8 Conclusion

To protect important assets, all organizations must take cybersecurity threats seriously and meet them proactively with a system-wide defensive approach specific to organizational needs.

There is no protection method that is completely secure. A defense mechanism that is effective today may not be effective tomorrow– the ways and means of cyber-attacks constantly change. It is critical ICS administrators remain aware of changes in cybersecurity and continue to work to prevent any potential vulnerabilities in the systems they manage.

5.1.9 Terms and definitions

DMZ	A demilitarized zone is a logical or physical sub network that interfaces an organization’s external services to a larger, untrusted network and providing an additional layer of security.
Encryption	The process of transforming plain or clear text using an algorithm to make it unreadable to anyone except those possessing special knowledge.
ICS	A device or set of device that manage, command, direct, or regulate the behavior of other devices or systems.
Protocol	A set of standard rules for data representation, signaling, authentication, and error detection required to send information over a communications channel

5.1.10 Acronyms

COTS	Commercially Off-the-Shelf
DMZ	Demilitarized Zone
DOS	Denial of Service
FTP	File Transfer Protocol
HMI	Human Machine Interface
ICS	Industrial Control Systems
ICS-CERT	Industrial Control Systems - Cyber Emergency Response Team
IDPS	Intrusion Detection and Prevention Systems
IDS	Intrusion Detection Systems

IPS	Intrusion Prevention Systems
IT	Information Technology
NVD	National Vulnerability Database
OSI	Open System Interconnection
PLC	Programmable Logic Controller
SCADA	Supervisory Control and Data Acquisition
SNMP	Simple Network Management Protocol
SSH	Secure Shell
SIEM	Security Information and Event Management
USB	Universal Serial Bus

5.1.11 References

- [1] Recommended Practice: Improving Industrial Control Systems Cybersecurity with Defense-In-Depth Strategies, October 2009
https://ics-cert.us-cert.gov/sites/default/files/FactSheets/NCCIC%20ICS_FactSheet_Defense_in_Depth_Strategies_S508C.pdf
- [2] NIST.SP.800-82 Guide to Industrial Control Systems (ICS) Security, June 2011
<http://csrc.nist.gov/publications/nistpubs/800-82/SP800-82-final.pdf>
- [3] NIST.SP.800-94 Guide to Intrusion Detection and Prevention Systems (IDPS), Feb 2007
<http://csrc.nist.gov/publications/nistpubs/800-94/SP800-94.pdf>
- [4] Common Cybersecurity Vulnerabilities in Industrial Control Systems, May 2011
http://ics-cert.uscert.gov/sites/default/files/recommended_practices/DHS_Common_Cybersecurity_Vulnerabilities_ICS_2010.pdf
- [5] The Tao of Network Security Monitoring, 2005 Richard Bejtlich

5.2 Cybersecurity recommended secure hardening guidelines

5.2.1 Introduction

This Network module has been designed with cybersecurity as an important consideration. Number of features are offered in the product to address cybersecurity risks. These Cybersecurity Recommendations provide information to help users to deploy and maintain the product in a manner that minimizes the cybersecurity risks. These Cybersecurity Recommendations are not intended to provide a comprehensive guide to cybersecurity, but rather to complement customers' existing cybersecurity programs.

Eaton is committed to minimizing the cybersecurity risk in its products and deploying cybersecurity best practices in its products and solutions, making them more secure, reliable and competitive for customers.

The following whitepapers are available for more information on general cybersecurity best practices and guidelines:

Cybersecurity Considerations for Electrical Distribution Systems (WP152002EN): http://www.eaton.com/ecm/groups/public/@pub/@eaton/@corp/documents/content/pct_1603172.pdf

Cybersecurity Best Practices Checklist Reminder (WP910003EN): http://www.cooperindustries.com/content/dam/public/powersystems/resources/library/1100_EAS/WP910003EN.pdf

Cybersecurity Best Practices for Modern Vehicles - NHTSA: https://www.nhtsa.gov/staticfiles/nvs/pdf/812333_CybersecurityForModernVehicles.pdf

5.2.2 Secure configuration guidelines

5.2.2.1 Asset Management

Keeping track of software and hardware assets in your environment is a pre-requisite for effectively managing cybersecurity. Eaton recommends that you maintain an asset inventory that uniquely identifies each important component.

To facilitate this, Network module supports the following identifying information:

5.2.2.1.1 Network Module identification and its firmware information

It can be retrieved by navigating to *Card>>>System information or Maintenance>>>System information*.

Identification

- System name
- Product
- Physical name
- Vendor
- UUID
- Part number
- Serial number
- Hardware version
- Location
- Contact

Firmware information

- Firmware version
- Firmware SHA
- Firmware date
- Firmware installation date
- Firmware activation date
- Bootloader version

5.2.2.1.2 Communication settings

It can be retrieved by navigating to *Settings>>>Network or Settings>>>Network & Protocol*

LAN

- Link status

- MAC address
- Configuration

IPV4

- Status
- Mode
- Address
- Netmask
- Gateway

Domain

- Mode
- FQDN
- Primary DNS
- Secondary DNS

IPV6

- Status
- Mode
- Addresses

5.2.2.1.3 UPS details

It can be retrieved by navigating to *Home>>>Details* or *Home>>>Energy flow* .

Details

- Name
- Model
- P/N
- S/N
- Location
- FW version



Most of above information are discoverable using SNMP, refer to *Settings>>>SNMP*.

5.2.2.2 Risk Assessment

Eaton recommends conducting a risk assessment to identify and assess reasonably foreseeable internal and external risks to the confidentiality, availability and integrity of the system | device and its environment. This exercise should be conducted in accordance with applicable technical and regulatory frameworks such as IEC 62443 and NERC-CIP. The risk assessment should be repeated periodically.

5.2.2.3 Physical Security

An attacker with unauthorized physical access can cause serious disruption to system/device functionality. Additionally, Industrial Control Protocols don't offer cryptographic protections, making ICS and SCADA communications especially vulnerable to threats to their confidentiality. Physical security is an important layer of defense in such cases. The Network module is designed to be deployed and operated in a physically secure location. Following are some best practices that Eaton recommends to physically secure your system/device:

- Secure the facility and equipment rooms or closets with access control mechanisms such as locks, entry card readers, guards, man traps, CCTV, etc. as appropriate.
- Restrict physical access to cabinets and/or enclosures containing the Network module and the associated system. Monitor and log the access at all times.
- Physical access to the telecommunication lines and network cabling should be restricted to protect against attempts to intercept or sabotage communications. It's a best practice to use metal conduits for the network cabling running between equipment cabinets.
- The Network module supports the following physical access ports: RJ45, USB A, USB Micro-B. Access to these ports should be restricted.

- Do not connect removable media (e.g., USB devices, SD cards, etc.) for any operation (e.g., firmware upgrade, configuration change, or boot application change) unless the origin of the media is known and trusted.
- Before connecting any portable device through a USB port or SD card slot, scan the device for malware and viruses.

5.2.2.4 Account management

Logical access to the system | device should be restricted to legitimate users, who should be assigned only the privileges necessary to complete their job roles/functions. Some of the following best practices may need to be implemented by incorporating them into the organization's written policies:

- Ensure default credentials are changed upon first login Network module should not be deployed in production environments with default credentials, as default credentials are publicly known.
- No account sharing – Each user should be provisioned a unique account instead of sharing accounts and passwords. Security monitoring/logging features in the product are designed based on each user having a unique account. Allowing users to share credentials weakens security.
- Restrict administrative privileges - Attackers seek to gain control of legitimate credentials, especially those for highly privileged accounts. Administrative privileges should be assigned only to accounts specifically designated for administrative duties and not for regular use.
- Leverage the roles / access privileges *admin*, *operator*, *viewer* to provide tiered access to the users as per the business / operational need. Follow the principle of least privilege (allocate the minimum authority level and access to system resources required for the role).
- Perform periodic account maintenance (remove unused accounts).
- Ensure password length, complexity and expiration requirements are appropriately set, particularly for all administrative accounts (e.g., minimum 10 characters, mix of upper- and lower-case and special characters, and expire every 90 days, or otherwise in accordance with your organization's policies).
- Enforce session time-out after a period of inactivity.

5.2.2.4.1 Description of the User management in the Network Module:

- User and profiles management: (Navigate to Settings>>>Users)
 - Add users (admin, operator, viewer)
 - Remove users
 - Edit users
- Password/Account/Session management: (Navigate to Settings>>>Users)
 - Password strength rules – Minimum length/Minimum upper case/Minimum lower case/Minimum digit/Special character
 - Account expiration – Number of days before the account expiration/Number of tries before blocking the account
 - Session expiration – No activity timeout/Session lease time
 - See "Default settings parameters" in the embedded help for (recommended) default values.
 - Additionally, it is possible to enable account expiration to force users renew their password periodically.
- Default credentials: admin/admin
 - The change of the default "admin" password is enforced at first connection.
 - It is also recommended to change the default "admin" user name through the *Settings>>>Users or Settings>>>Local users* page.
 - Follow embedded help for instructions on how to edit a user account.
- Local and Trusted remote certificate configuration: (Navigate to Settings>>>Certificate)
 - Follow embedded help for instructions on how to configure it.
- Supported authentication: LDAP and Radius, follow embedded help for instructions on how to configure it.

5.2.2.5 System clock

Ensure the system clock is synchronized with an authoritative time source (using manual configuration, NTP). (Navigate to Settings>>>General>>>Time&date settings)

Follow embedded help for instructions on how to configure it.

5.2.2.6 Deactivate unused features

Network module provides multiple options to upgrade firmware, change configurations, set power schedules, etc. The device also provide multiple options to connect with the device i.e. SSH, SNMP,SMTP,HTTPS etc. Services like SNMPv1 are considered insecure and Eaton recommends disabling all such insecure services.

- It is recommended to disable unused physical ports like USB and SD card.
- Disable insecure services like SNMP v1

5.2.2.7 Network Security

Network module supports network communication with other devices in the environment. This capability can present risks if it's not configured securely. Following are Eaton recommended best practices to help secure the network. Additional information about various network protection strategies is available in *Eaton Cybersecurity Considerations for Electrical Distribution Systems [R1]*.

Eaton recommends segmentation of networks into logical enclaves, denying traffic between segments except that which is specifically allowed, and restricting communication to host-to-host paths (for example, using router ACLs and firewall rules). This helps to protect sensitive information and critical services and creates additional barriers in the event of a network perimeter breach. At a minimum, a utility Industrial Control Systems network should be segmented into a three-tiered architecture (as recommended by NIST SP 800-82[R3]) for better security control.

Communication Protection: Network module provides the option to encrypt its network communications. Please ensure that encryption options are enabled. You can secure the product's communication capabilities by taking the following steps:

- Local and Trusted remote certificate configuration: (Navigate to Settings>>>Certificate)
Follow embedded help for instructions on how to configure it.

Eaton recommends opening only those ports that are **required** for operations and protect the network communication using network protection systems like firewalls and intrusion detection systems / intrusion prevention systems. Use the information below to configure your firewall rules to allow access needed for Network module to operate smoothly

- Navigate to *Information>>>Specifications/Technical characteristics>>>Port* to get the list of all ports and services running on the device.
- SNMP V1/SNMP V3 can be disabled or configured by navigating to *Settings>>>SNMP*.
Follow embedded help for instructions on how to configure it.
- If available, Modbus and Bacnet can be configured by navigating to Settings>>>Protocols or Settings>>>Industrial protocols.
Follow embedded help for instructions on how to configure it.

5.2.2.8 Remote access

Remote access to devices/systems creates another entry point into the network. Strict management and validation of termination of such access is vital for maintaining control over overall ICS security.

Remote access capabilities and permissions can be configured in Settings>>>Remote users for LDAP and Radius.

Follow embedded help for instructions on how to configure it.

5.2.2.9 Logging and Event Management

Navigate to Information>>>List of events codes to get log information and how to export it.

Best Practices

- Eaton recommends logging all relevant system and application events, including all administrative and maintenance activities.
- Logs should be protected from tampering and other risks to their integrity (for example, by restricting permissions to access and modify logs, transmitting logs to a security information and event management system, etc.).
- Ensure that logs are retained for a reasonable and appropriate length of time.
- Review the logs regularly. The frequency of review should be reasonable, taking into account the sensitivity and criticality of the system | device and any data it processes.

5.2.2.10 Malware defenses

Eaton recommends deploying adequate malware defenses to protect the product or the platforms used to run the Eaton product.

5.2.2.11 Secure Maintenance

Troubleshooting information are available in the embedded help for diagnostic purposes.

The Network module includes also Servicing, Securing sections to allow a service engineer with help from site administrator to trouble shoot the device functionality.

- Configuring/Commissioning/Testing LDAP
- Pairing agent to the Network Module
- Powering down/up applications (examples)
- Checking the current firmware version of the Network Module
- Accessing to the latest Network Module firmware/driver/script
- Upgrading the card firmware (Web interface / shell script)
- Changing the RTC battery cell
- Updating the time of the Network Module precisely and permanently (ntp server)
- Synchronizing the time of the Network Module and the UPS
- Changing the language of the web pages
- Resetting username and password
- Recovering main administrator password
- Switching to static IP (Manual) / Changing IP address of the Network Module
- Reading device information in a simple way
- Subscribing to a set of alarms for email notification
- Saving/Restoring/Duplicating Network module configuration settings
- Configuring user permissions through profiles
- Decommissioning the Network Management module

5.2.2.11.1 Best Practices

Update device firmware prior to putting the device into production. Thereafter, apply firmware updates and software patches regularly.

Eaton publishes patches and updates for its products to protect them against vulnerabilities that are discovered. Eaton encourages customers to maintain a consistent process to promptly monitor for and install new firmware updates.

Please check Eaton's cybersecurity website for information bulletins about available firmware and software updates.

- Navigate in the help to *Contextual help*>>>*Card*>>>*Administration* to get information on how to upgrade the Network Module.
- Eaton also has a robust vulnerability response process. In the event of any security vulnerability getting discovered in its products, Eaton patches the vulnerability and releases information bulletin through its cybersecurity web site - <http://eaton.com/cybersecurity> and patch through www.eaton.com/downloads.

5.2.2.12 Business Continuity / Cybersecurity Disaster Recovery

5.2.2.12.1 Plan for Business Continuity / Cybersecurity Disaster Recovery

Eaton recommends incorporating the Network module into the organization's business continuity and disaster recovery plans. Organizations should establish a Business Continuity Plan and a Disaster Recovery Plan and should periodically review and, where possible, exercise these plans. As part of the plan, important system | device data should be backed up and securely stored, including:

- Updated firmware for the Network module. Make it a part of standard operating procedure to update the backup copy as soon as the latest firmware is updated.
- The current configuration.
- Documentation of the current permissions / access controls, if not backed up as part of the configuration.

The following section describes the details of failures states and backup functions:

- Communication and power status indicators: Navigate in the help to Information>>>Front panel connectors and LED indicators.
- Configuration of backup and recovery: Navigate in the help to Servicing the Network Management Module>>>Saving/Restoring/Duplicating Network module configuration settings.

5.2.2.13 Sensitive Information Disclosure

Eaton recommends that sensitive information (i.e. connectivity, log data, personal information) that may be stored by Network module be adequately protected through the deployment of organizational security practices.

- Full name
- Email
- Phone
- Organization
- The mail credentials in the CDS storage
- PKI signed server's (HTTP + MQTT) certificate and associated private key
- Server's (HTTP + MQTT) self-signed private keys (they are self-generated by the device upon user request, so unique per device)
- Username's (in clear) and their "vCard" (Full name, Organization, Phone, Email, ...)
- Hashed passwords
- IP addresses, hostnames (DNS, Gateway, mail servers, ...) of customer network devices (in database or logs)
- Maintenance report AES key/password

5.2.2.14 Decommissioning or Zeroization

It is a best practice to purge data before disposing of any device containing data. Guidelines for decommissioning are provided in NIST SP 800-88. Eaton recommends that products containing embedded flash memory be securely destroyed to ensure data is unrecoverable.

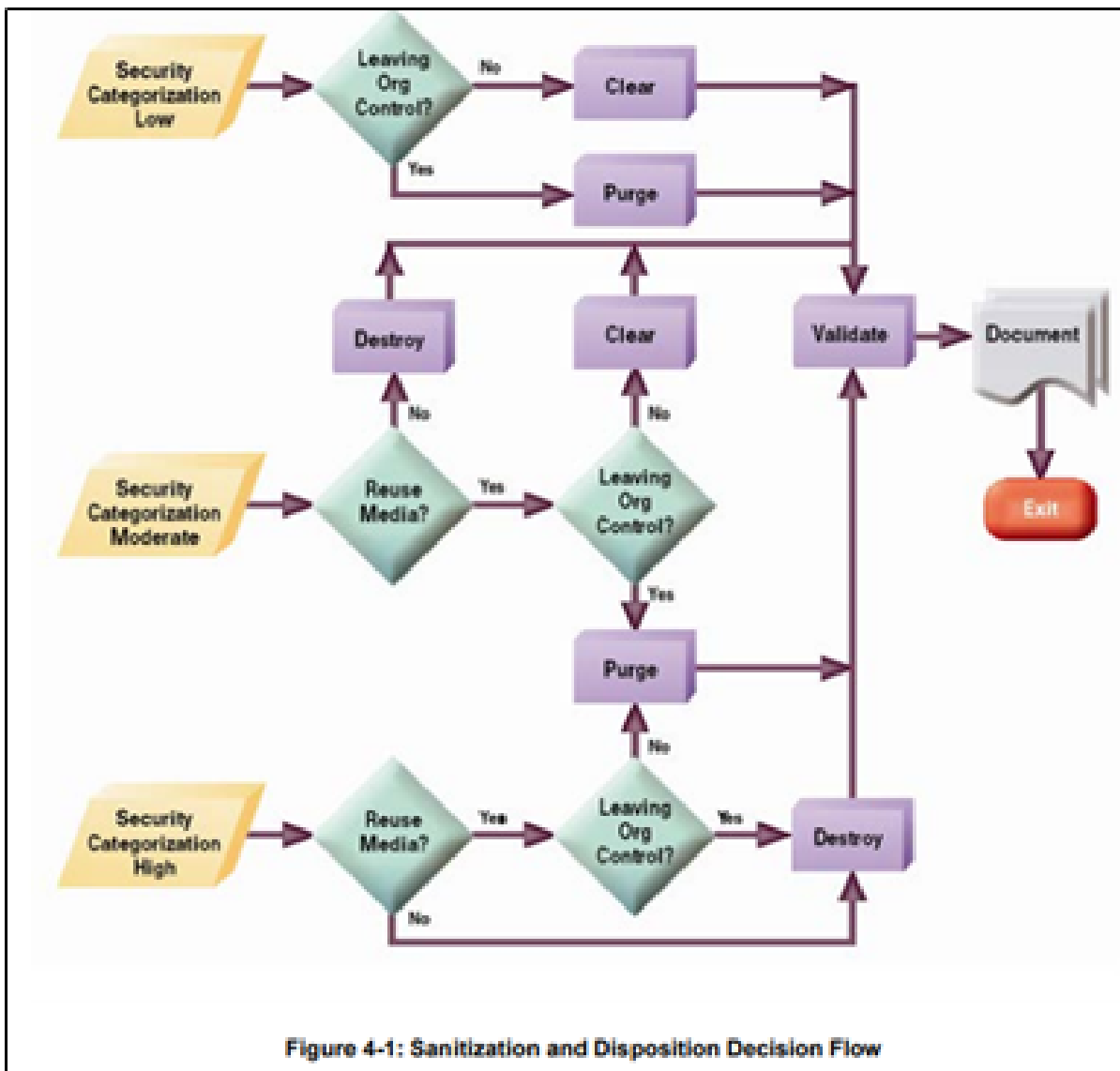

*Figure and data from NIST SP800-88

- **Embedded Flash Memory on Boards and Devices**
- Eaton recommends the following methods for disposing of motherboards, peripheral cards such as network adapters, or any other adapter containing non-volatile flash memory.
- **Clear:** If supported by the device, reset the state to original factory settings.
Navigate to Securing the Network Management Module>>>Decommissioning the Network Management module.
- **Purge:** If the flash memory can be easily identified and removed from the board, the flash memory may be destroyed independently of the board that contained the flash memory. Otherwise, the whole board should be destroyed. For the Network module the whole board should be destroyed.
- **Destroy:** Shred, disintegrate, pulverize, or Incinerate by burning the device in a licensed incinerator.

5.2.3 References

- [R1] Cybersecurity Considerations for Electrical Distribution Systems (WP152002EN): http://www.eaton.com/ecm/groups/public/@pub/@eaton/@corp/documents/content/pct_1603172.pdf
- [R2] Cybersecurity Best Practices Checklist Reminder (WP910003EN): http://www.cooperindustries.com/content/dam/public/powersystems/resources/library/1100_EAS/WP910003EN.pdf
- [R3] NIST SP 800-82 Rev 2, Guide to Industrial Control Systems (ICS) Security, May 2015: <https://nvlpubs.nist.gov/nistpubs/SpecialPublications/NIST.SP.800-82r2.pdf>
- [R4] National Institute of Technology (NIST) Interagency "Guidelines on Firewalls and Firewall Policy, NIST Special Publication 800-41", October 2009: <http://nvlpubs.nist.gov/nistpubs/Legacy/SP/nistspecialpublication800-41r1.pdf>

[R5] NIST SP 800-88, Guidelines for Media Sanitization, September 2006: http://ws680.nist.gov/publication/get_pdf.cfm?pub_id=50819

[R6] Cybersecurity Best Practices for Modern Vehicles - NHTSA: https://www.nhtsa.gov/staticfiles/nvs/pdf/812333_CybersecurityForModernVehicles.pdf

[R7] A Summary of Cybersecurity Best Practices - Homeland Security: <https://www.hsdl.org/?view&did=806518>

[R8] Characterization of Potential Security Threats in Modern Automobiles - NHTSA: [https://www.nhtsa.gov/DOT/NHTSA/NVS/Crash%20Avoidance/Technical%20Publications/2014/812074_Characterization_PotentialThreatsAutos\(1\).pdf](https://www.nhtsa.gov/DOT/NHTSA/NVS/Crash%20Avoidance/Technical%20Publications/2014/812074_Characterization_PotentialThreatsAutos(1).pdf)

[R9] Threat Modeling for Automotive Security Analysis: <http://nvlpubs.nist.gov/nistpubs/Legacy/SP/nistspecialpublication800-41r1.pdf>

5.3 Configuring user permissions through profiles

The user profile can be defined when creating a new users or changed when modifying an existing one.

Refer to the section [Contextual help>>>Settings>>>Local users](#) in the settings.

5.4 Decommissioning the Network Management module

With the increased frequency of reported data breaches, it's becoming more and more necessary for companies to implement effective and reliable decommissioning policies and procedures.

In order to protect the data stored on retired IT equipment from falling into the wrong hands, or a data breach, we recommend to follow below decommissioning steps:

1- Sanitize the Network Module

Sanitization erases all the data (user name and password, certificates, keys, settings, logs...).

To sanitize the Network Module refer to the [Contextual help>>>Maintenance>>>Services>>>Sanitization](#) section.

2- Unmount the Network Module from the device.

Unscrew the Network Module and remove it from the slot.

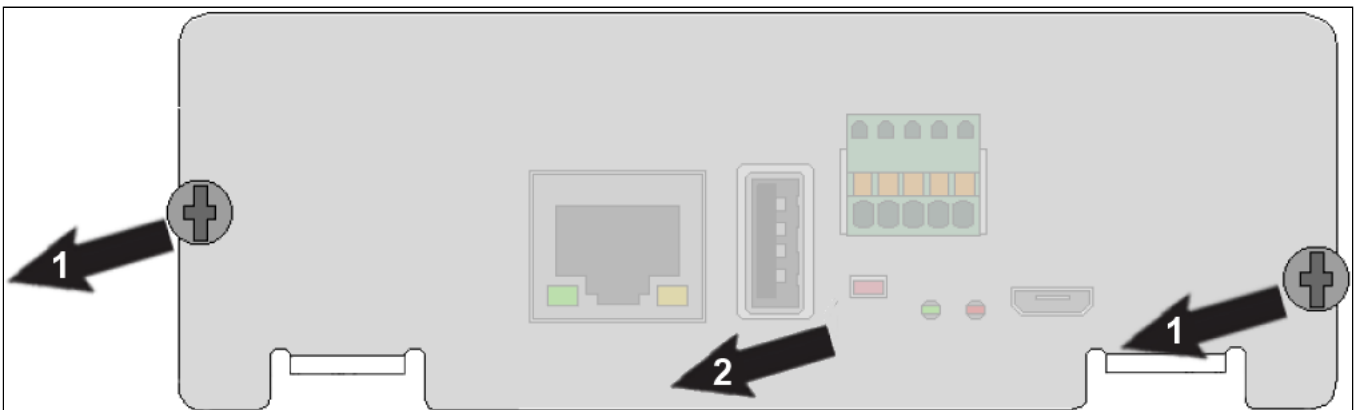

6 Servicing the EMP

6.1 Installing the EMP

6.1.1 Mounting the EMP

The EMP includes magnets, cable ties slots and keyholes to enable multiple ways of mounting it on your installation.

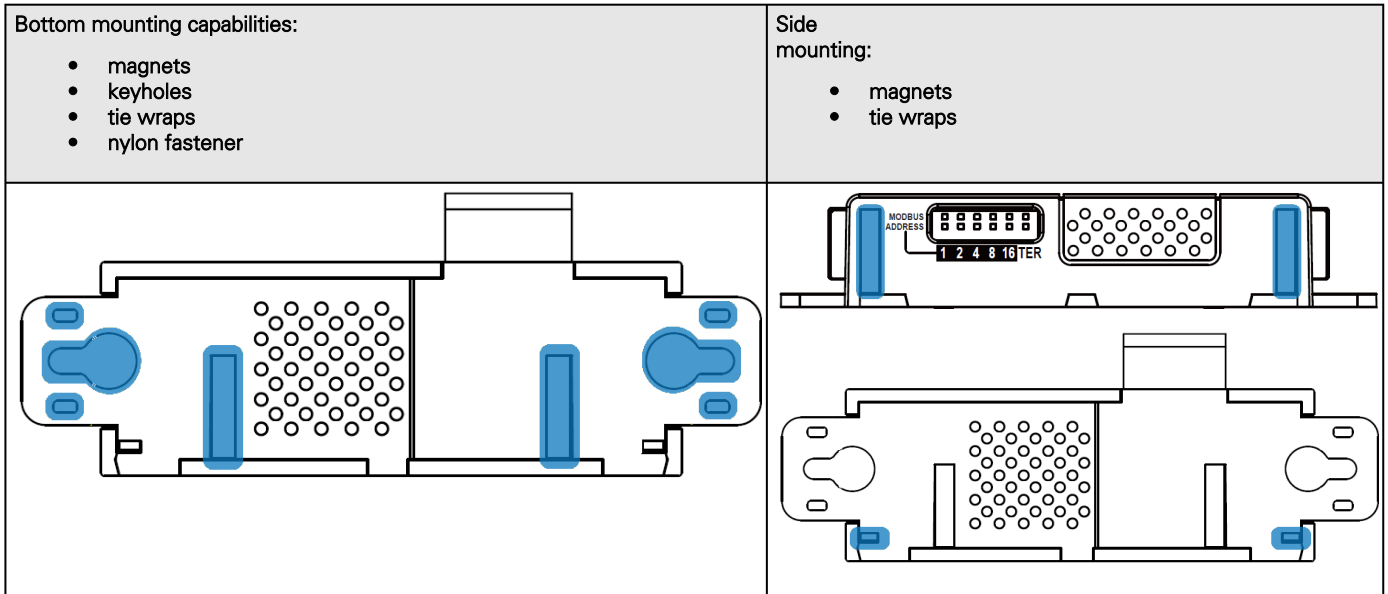

6.1.1.1 Rack mounting with keyhole example

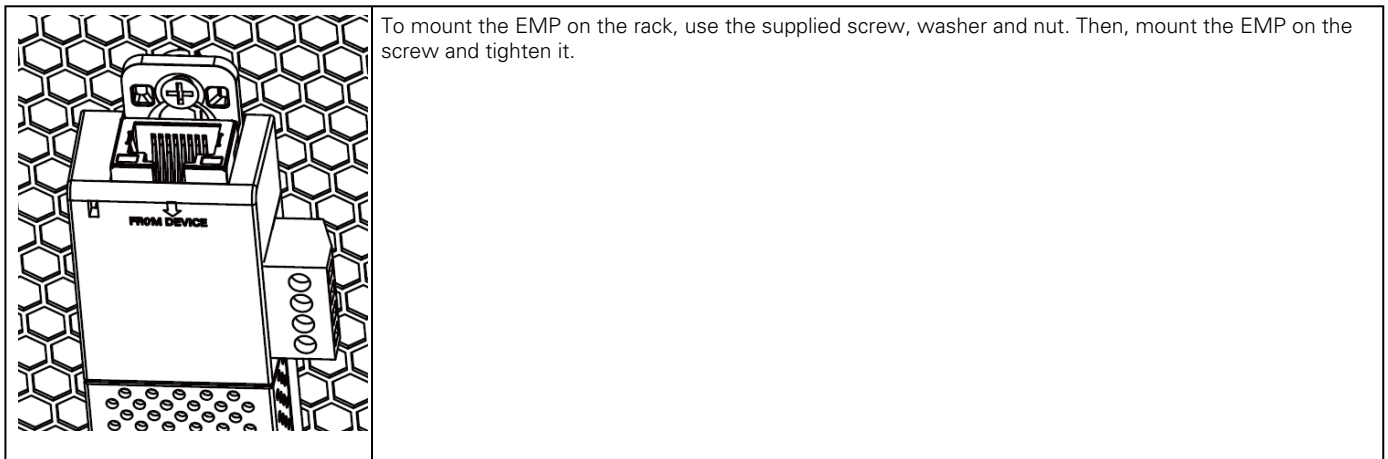

6.1.1.2 Rack mounting with tie wraps example

To mount the EMP on the door of the rack, use the supplied cable ties.

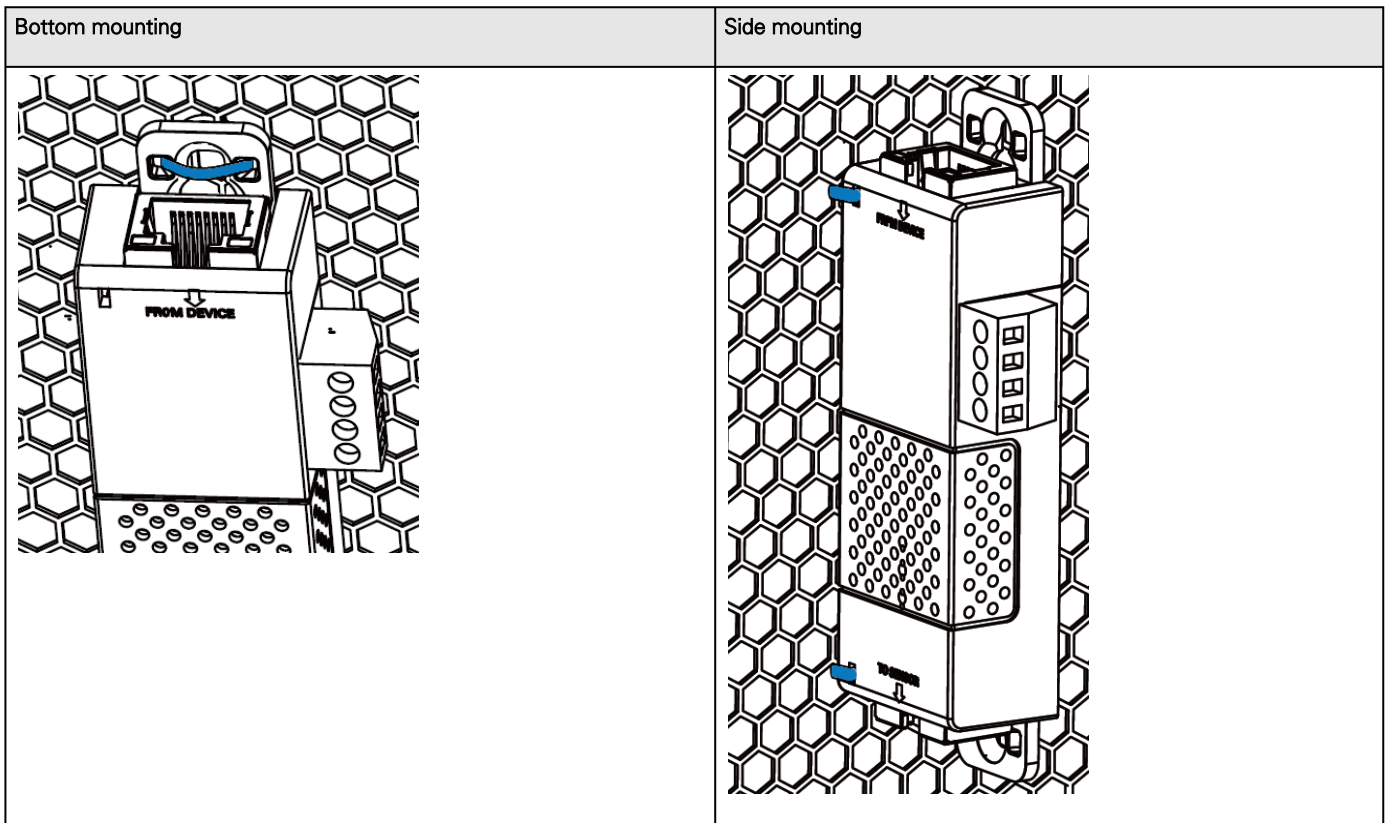

6.1.1.3 Wall mounting with screws example

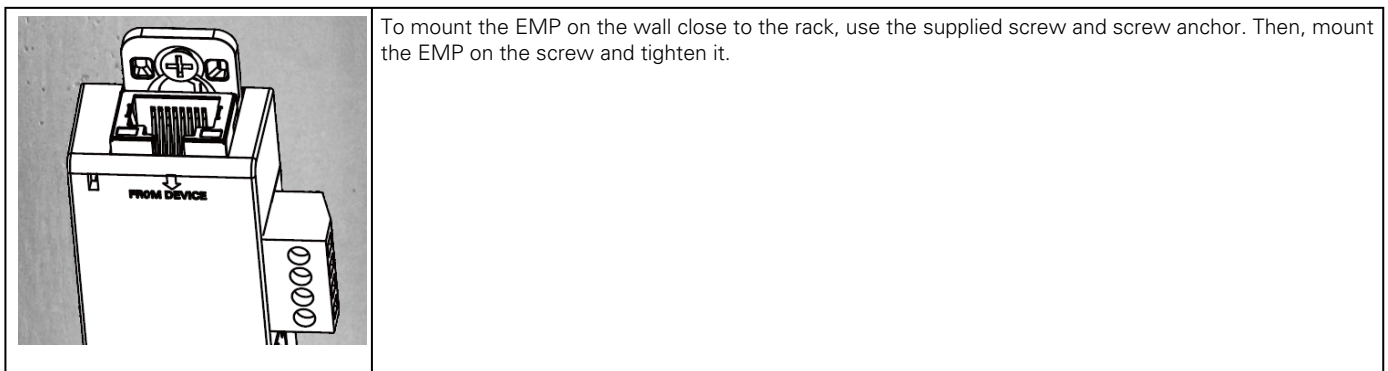

6.1.1.4 Wall mounting with nylon fastener example

To mount the EMP within the enclosure environment, attach one nylon fastener to the EMP and the other nylon fastener to an enclosure rail post. Then, press the two nylon strips together to secure the EMP to the rail post.



Cut nylon fastener and stick it on the EMP bottom on the location highlighted below, this will prevent to interfere with the EMP data acquisition parts.

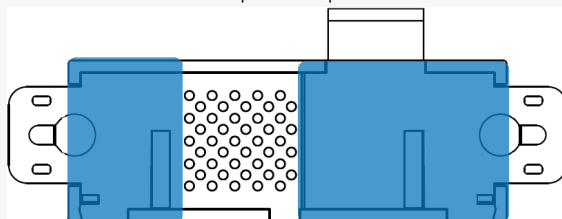

6.2 Using the EMP for temperature compensated battery charging

This section applies only to UPS that provides temperature compensated battery charging option.



Address must be defined before EMP power-up; otherwise, the changes will not be applied.
Do not set Modbus address to 0; otherwise, the EMP will not be detected.
Define a **unique address** for all the EMPs in the daisy-chain.
Set the RS485 termination (TER) to 1 on the last EMP of the daisy chain. On other EMPs this should be set to 0.

6.2.1 Addressing the EMP

Set the address 31 to the sensor dedicated to the battery room temperature:

- Set all the Modbus address switches to 1 to set the EMP to the address 31 as indicated on the picture below:

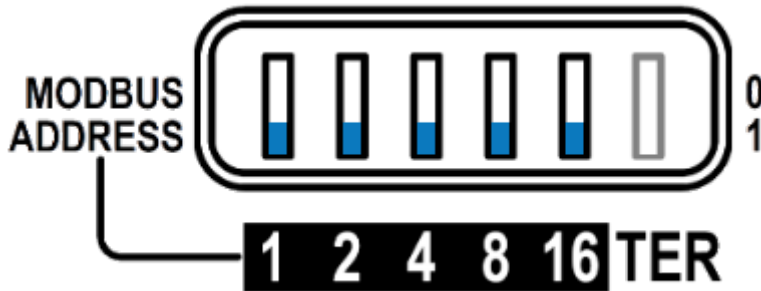

6.2.2 Commissioning the EMP

Refer to the section [Contextual help>>>Environment>>>Commissioning/Status](#).

6.2.3 Enabling temperature compensated battery charging in the UPS





The temperature compensated battery charging feature needs to be enabled in the UPS.

To enable the temperature compensated battery charging, refer to the UPS user manual.

7 Information

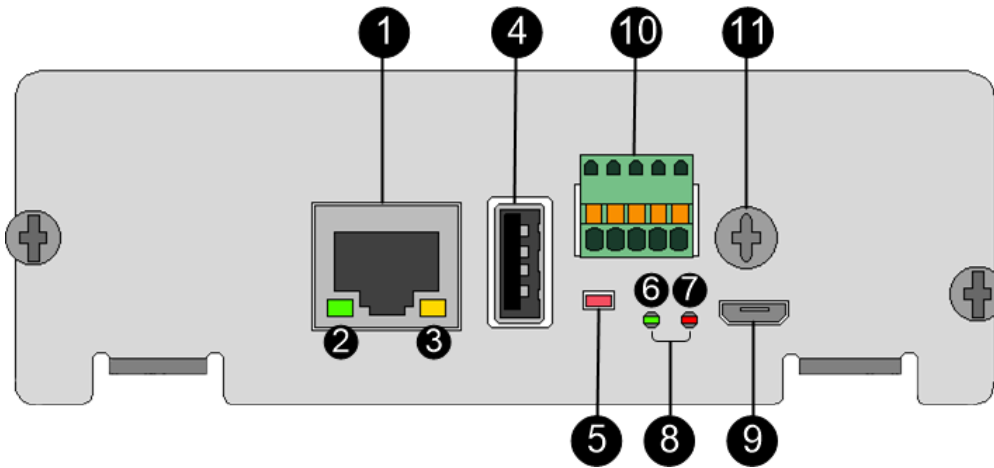
7.1 Front panel connectors and LED indicators



Nbr	Name	Description
1	Network connector	Ethernet port
2	Network speed LED	Flashing green sequences: <ul style="list-style-type: none"> 1 flash — Port operating at 10Mbps 2 flashes — Port operating at 100Mbps 3 flashes — Port operating at 1Gbps
3	Network link/activity LED	<ul style="list-style-type: none"> Off — UPS Network Module is not connected to the network. Solid yellow — UPS Network Module is connected to the network, but no activity detected. Flashing yellow — UPS Network Module is connected to the network and sending or receiving data.
4	AUX connector	For Network Module accessories only. <div style="border: 1px solid black; padding: 5px; text-align: center;">  <i>Do not use for general power supply or USB charger.</i> </div>
5	Restart button	Ball point pen or equivalent will be needed to restart: <ul style="list-style-type: none"> Short press (<6s) — Safe software restart (firmware safely shutdown before restart). Long press (>9s) — Forced hardware restart.
6	ON LED	Flashing green — Network Module is operating normally.
7	Warning LED	Solid red — Network Module is in error state.

8	Boot LEDs	Solid green and flashing red — Network Module is starting boot sequence.
9	Settings/UPS data connector	Configuration port. Access to Network Module's web interface through RNDIS (Emulated Network port). Access to the Network Module console through Serial (Emulated Serial port).
10	Modbus connector	Detachable terminal block with push-in connections: 0V / T+ / T- / R+ / R-
11	Shield	Depending on the cabling this location may be used as a shield reference.

7.2 Specifications/Technical characteristics

Physical characteristics	
Dimensions (wxdxh)	132 x 66 x 42 mm 5.2 x 2.6 x 1.65 in
Weight	70 g 0.15 lb
RoHS	100% compatible
Storage	
Storage temperature	-25°C to 70°C (14°F to 158°F)
Ambient conditions	
Operating temperature	0°C to 70°C (32°F to 158°F)
Relative humidity	5%-95%, noncondensing
Module performance	
Module input power	5V-12V ±5% 1A
AUX output power	5V ±5% 200mA
Date/Time backup	CR1220 battery coin cell The RTC is able to keep the date and the time when Network Module is OFF
Functions	
Languages	English, French, German, Italian, Japanese, Russian, Simplified Chinese, Spanish, Traditional Chinese
Alarms/Log	Email, SNMP trap, web interface / Log on events
Network	Gigabit ETHERNET, 10/100/1000Mb/s, auto negotiation, HTTP 1.1, SNMP V1, SNMP V3, NTP, SMTP, DHCP
Security	Restricted to TLS 1.2
Supported MIBs	<i>xUPS MIB Standard IETF UPS MIB (RFC 1628) Sensor MIB</i>

Browsers	Internet Explorer, Google Chrome, Firefox, Safari
Settings (default values)	
IP network	DHCP enabled NTP server: pool.ntp.org
Port	443 (https), 22 (ssh), 161 (snmp), 162 (snmp trap), 25 (smtp), 8883 (mqtt), 123 (ntp), 5353 (mdns-sd), 80 (http), 514 (syslog), 636 (LDAP), 1812 (RADIUS)
Web interface access control	User name: admin Password: admin
Settings/Device data connector	USB RNDIS Apipa compatible IP address: 169.254.0.1 Subnet mask: 255.255.0.0

7.3 Default settings and possible parameters

7.3.1 Settings

Default settings and possible parameters - General

	Default setting	Possible parameters
System details	Location — empty Contact — empty System name — empty Time & date settings — Manual (Time zone: Europe/Paris)	Location — 31 characters maximum Contact — 255 characters maximum System name — 255 characters maximum Time & date settings — Manual (Time zone: selection on map/Date) / Dynamic (NTP)

<p>Email notification settings</p>	<p>No email</p>	<p>5 configurations maximum</p> <p>Custom name — 128 characters maximum</p> <p>Email address — 128 characters maximum</p> <p>Hide IP address from the email body — enable/disabled</p> <p>Status — Active/Inactive</p> <ul style="list-style-type: none"> Alarm notifications <ul style="list-style-type: none"> Active — No/Yes All card events – Subscribe/Attach logs Critical alarm – Subscribe/Attach logs Warning alarm – Subscribe/Attach logs Info alarm – Subscribe/Attach logs All device events – Subscribe/Attach measures/Attach logs <ul style="list-style-type: none"> Critical alarm – Subscribe/Attach measures/Attach logs Warning alarm – Subscribe/Attach measures/Attach logs Info alarm – Subscribe/Attach measures/Attach logs <p>Always notify events with code Never notify events with code</p> <ul style="list-style-type: none"> Schedule report <ul style="list-style-type: none"> Active — No/Yes Recurrence – Every day/Every week/Every month Starting – Date and time Card events – Subscribe/Attach logs Device events – Subscribe/Attach measures/Attach logs
<p>SMTP settings</p>	<p>Server IP/Hostname — blank</p> <p>SMTP server authentication — disabled</p> <p>Port — 25</p> <p>Default sender address — device@networkcard.com</p> <p>Hide IP address from the email body — disabled</p> <p>Security — enabled</p> <p>Verify certificate authority — disabled</p> <p>SMTP server authentication — disabled</p>	<p>Server IP/Hostname — 128 characters maximum</p> <p>SMTP server authentication — disable/enable (Username/Password — 128 characters maximum)</p> <p>Port — x-xxx</p> <p>Sender address — 128 characters maximum</p> <p>Hide IP address from the email body — enable/disabled</p> <p>Secure SMTP connection — enable/disable</p> <p>Verify certificate authority — disable/enable</p>

Default settings and possible parameters - Global user settings and Local users

	Default setting	Possible parameters
--	-----------------	---------------------

Password settings	Minimum length — enabled (8) Minimum upper case — enabled (1) Minimum lower case — enabled (1) Minimum digit — enabled (1) Special character — enabled (1)	Minimum length — enable (6-32)/disable Minimum upper case — enable (0-32)/disable Minimum lower case — enable (0-32)/disable Minimum digit — enable (0-32)/disable Special character — enable (0-32)/disable
Password expiration	Number of days until password expires — disabled Main administrator password never expires — disabled	Number of days until password expires — disable/enable (1-99999) Main administrator password never expires — disable/enable
Lock account	Lock account after xx invalid tries — disabled Main administrator account never blocks — disabled	Lock account after xx invalid tries — disable/enable (1-99) Main administrator account never blocks — disable/enable
Account timeout	No activity timeout — 15 minutes Session lease time — 120 minutes	No activity timeout — 1-60 minutes Session lease time — 60-720 minutes
Local users	1 user only: <ul style="list-style-type: none"> • Active — Yes • Profile — Administrator • Username — admin • Full Name — blank • Email — blank • Phone — blank • Organization — blank 	10 users maximum: <ul style="list-style-type: none"> • Active — Yes/No • Profile — Administrator/Operator/Viewer • Username — 255 characters maximum • Full Name — 128 characters maximum • Email — 128 characters maximum • Phone — 64 characters maximum • Organization — 128 characters maximum

Default settings and possible parameters - Remote users

	Default setting	Possible parameters
--	-----------------	---------------------

<p>LDAP</p>	<p>Configure</p> <ul style="list-style-type: none"> • Active – No • Security <ul style="list-style-type: none"> SSL – SSL Verify server certificate – enabled • Primary server <ul style="list-style-type: none"> Name – Primary Hostname – blank Port – 636 • Secondary server <ul style="list-style-type: none"> Name – blank Hostname – blank Port – blank • Credentials <ul style="list-style-type: none"> Anonymous search bind – disabled Search user DN – blank Password – blank • Search base <ul style="list-style-type: none"> Search base DN – dc=example,dc=com • Request parameters <ul style="list-style-type: none"> User base DN – ou=people,dc=example,dc=com User name attribute – uid UID attribute – uidNumber Group base DN – ou=group,dc=example,dc=com Group name attribute – gid GID attribute – gidNumber <p>Profile mapping – no mapping</p> <p>Users preferences</p> <ul style="list-style-type: none"> • Language – English • Temperature unit – °C (Celsius) • Date format – m/d/Y • Time format – hh:mm:ss (24h) 	<p>Configure</p> <ul style="list-style-type: none"> • Active – No/yes • Security <ul style="list-style-type: none"> SSL – None/Start TLS/SSL Verify server certificate – disabled/enabled • Primary server <ul style="list-style-type: none"> Name – 128 characters maximum Hostname – 128 characters maximum Port – x-xxx • Secondary server <ul style="list-style-type: none"> Name – 128 characters maximum Hostname – 128 characters maximum Port – x-xxx • Credentials <ul style="list-style-type: none"> Anonymous search bind – disabled/enabled Search user DN – 1024 characters maximum Password – 128 characters maximum • Search base <ul style="list-style-type: none"> Search base DN – 1024 characters maximum • Request parameters <ul style="list-style-type: none"> User base DN – 1024 characters maximum User name attribute – 1024 characters maximum UID attribute – 1024 characters maximum Group base DN – 1024 characters maximum Group name attribute – 1024 characters maximum GID attribute – 1024 characters maximum <p>Profile mapping – up to 5 remote groups mapped to local profiles</p> <p>Users preferences</p> <ul style="list-style-type: none"> • Language – English, French, German, Italian, Japanese, Russian, Simplified Chinese, Spanish, Traditional Chinese • Temperature unit – °C (Celsius)/°F (Fahrenheit) • Date format – MM-DD-YYYY / YYYY-MM-DD / DD-MM-YYY / DD.MM.YYY / DD/MM/YYYY / DD MM YYYY • Time format – hh:mm:ss (24h) / hh:mm:ss (12h)
<p>RADIUS</p>	<p>Configure</p> <ul style="list-style-type: none"> • Active – No • Retry number – 0 • Primary server <ul style="list-style-type: none"> Name – blank Secret – blank Address – blank UDP port – 1812 Time out – 3 	<p>Configure</p> <ul style="list-style-type: none"> • Active – Yes/No • Retry number – 0 to 128 • Primary server <ul style="list-style-type: none"> Name – 128 characters maximum Address – 128 characters maximum Secret – 128 characters maximum UDP port – 1 to 65535 Time out – 3 to 60

	<ul style="list-style-type: none"> • Secondary server Name – blank Secret – blank Address – blank UDP port – 1812 Time out – 3 <p>Users preferences</p> <ul style="list-style-type: none"> • Language – English • Temperature unit – °C (Celsius) • Date format – m/d/Y • Time format – hh:mm:ss (24h) 	<ul style="list-style-type: none"> • Secondary server Name – 128 characters maximum Address – 128 characters maximum Secret – 128 characters maximum UDP port – 1 to 65535 Time out – 3 to 60 <p>Users preferences</p> <ul style="list-style-type: none"> • Language – English, French, German, Italian, Japanese, Russian, Simplified Chinese, Spanish, Traditional Chinese • Temperature unit – °C (Celsius) • Date format – MM-DD-YYYY • Time format – hh:mm:ss (24h)
--	---	---

Default settings and possible parameters - Network & Protocol

	Default setting	Possible parameters
IPV4	Mode — DHCP	Mode — DHCP/Manual (Address/Netmask/Gateway)
IPV6	Enable — checked Mode — DHCP	Enabled — Active/Inactive Mode — DHCP/Manual (Address/Prefix/Gateway)
DNS/DHCP	Hostname — <i>device</i> -[MAC address] Mode — DHCP	Hostname — 128 characters maximum Mode :DHCP/Manual (Domain name/Primary DNS/Secondary DNS)
Ethernet	Configuration — Auto negotiation	Configuration — Auto negotiation - 10Mbps - Half duplex - 10Mbps - Full duplex - 100Mbps - Half duplex - 100Mbps - Full duplex - 1.0 Gbps - Full duplex
HTTPS	Port — 443	Port — x-xxx

Syslog	Inactive	Inactive/Active
	<ul style="list-style-type: none"> • Server#1 <ul style="list-style-type: none"> Name – Primary Status – Disabled Hostname – empty Port – 514 Protocol – UDP Message transfer method – Non transparent framing Using unicode byte order mask (BOM) – disabled • Server#2 <ul style="list-style-type: none"> Name – empty Status – Disabled Hostname – empty Port – 514 Protocol – UDP Message transfer method – Disabled in UDP Using unicode byte order mask (BOM) – disabled 	<ul style="list-style-type: none"> • Server#1 <ul style="list-style-type: none"> Name – 128 characters maximum Status – Disabled/Enabled Hostname – 128 characters maximum Port – x-xxx Protocol – UDP/TCP Message transfer method – Non transparent framing Using unicode byte order mask (BOM) – disable/enable • Server#2 <ul style="list-style-type: none"> Name – 128 characters maximum Status – Disabled/Enabled Hostname – 128 characters maximum Port – x-xxx Protocol – UDP/TCP Message transfer method (in TCP) – Octet counting/Non transparent framing Using unicode byte order mask (BOM) – disable/enable

Default settings and possible parameters - SNMP

	Default setting	Possible parameters
--	-----------------	---------------------

<p>SNMP</p>	<p>Activate SNMP — disabled</p> <p>Port — 161</p> <p>SNMP V1 — disabled</p> <ul style="list-style-type: none"> Community #1 — public Enabled — Inactive Access — Read only Community #2 — private Enabled — Inactive Access — Read/Write <p>SNMP V3 — enabled</p> <ul style="list-style-type: none"> User #1 — readonly Enabled — Inactive Access — Read only Authentication — Auth (SHA-1) Password — empty Confirm password — empty Privacy — Secured - AES Key — empty Confirm key — empty User#2 — readwrite Enabled — Inactive Access — Read/Write Authentication — Auth (SHA-1) Password — empty Confirm password — empty Privacy — Secured - AES Key — empty Confirm key — empty 	<p>Activate SNMP — disable/enable</p> <p>Port — x-xxx</p> <p>SNMP V1 — disable/enable</p> <ul style="list-style-type: none"> Community #1 — 128 characters maximum Enabled — Inactive/Active Access — Read only Community #2 — 128 characters maximum Enabled — Inactive/Active Access — Read/Write <p>SNMP V3 — disable/enable</p> <ul style="list-style-type: none"> User #1 — 32 characters maximum Enabled — Inactive/Active Access — Read only/Read-Write Authentication — Auth (SHA-1)/None Password — 128 characters maximum Confirm password — 128 characters maximum Privacy — Secured - AES/None Key — 128 characters maximum Confirm key — 128 characters maximum User#2 — 32 characters maximum Enabled — Inactive/Active Access — Read only/Read-Write Authentication — Auth (SHA-1)/None Password — 128 characters maximum Confirm password — 128 characters maximum Privacy — Secured - AES/None Key — 128 characters maximum Confirm key — 128 characters maximum
<p>Trap receivers</p>	<p>No trap</p>	<p>Enabled — No/Yes</p> <p>Application name — 128 characters maximum</p> <p>Hostname or IP address — 128 characters maximum</p> <p>Port — x-xxx</p> <p>Protocol — V1</p> <p>Trap community — 128 characters maximum</p>

Default settings and possible parameters - Industrial protocols

	Default setting	Possible parameters
<p>Modbus RTU</p>	<p>Modbus RTU — Inactive</p> <p>Baud rate (bps) — 19200</p> <p>Parity — Even</p> <p>Stop bits — 1</p>	<p>Modbus RTU — Inactive/Active</p> <p>Baud rate (bps) — 1200/2400/4800/9600/19200/38400/57600/115200</p> <p>Parity — None/Even/Odd</p> <p>Stop bits — 1/2</p>

Modbus TCP	Modbus TCP — Inactive Port — 502	Modbus TCP — Inactive/Active Port — x-xxx
Mapping configuration	No mapping	<p>Custom name – 128 characters maximum</p> <p>Map – Eaton ModbusMS compatible, Eaton PowerXpert UID 0 compatible, Card System Information</p> <p>Transport – RTU/TCP</p> <p>Access – None/Read only/Read/Write</p> <p>Illegal read behaviour – Return exception/Return zeros</p> <p>IP filtering – IP address</p> <p>Coil/register base address shift – No shift/Shift by 1 (JBUS)</p>
BACnet	BACnet IP — Inactive	<p>BACnet IP — Inactive/Active</p> <p>Device Id — Automatically generated, must be unique, 4194304 characters maximum</p> <p>Device Name — Automatically generated, must be unique, 1-255 characters maximum, only Latin letters, numbers, spaces, '_' and '!' symbols</p> <p>Device connection control password — 6-20 characters maximum</p> <p>Local port — 1-65535 characters maximum (as all the other UDP and TCP ports)</p> <p>MAC address — MAC address format</p> <p>Broadcast management device — Inactive/Active</p> <p>BBMD BACnet/IP device — IP address format</p> <p>BBMD Time to live — 30-1800 seconds</p>

Default settings and possible parameters - Certificate

	Default setting	Possible parameters
Local certificates	Common name — Service + Hostname + selfsigned Country — FR State or Province — 38 City or Locality — Grenoble Organization name — Eaton Organization unit — Power quality Contact email address — blank	Common name — 64 characters maximum Country — Country code State or Province — 64 characters maximum City or Locality — 64 characters maximum Organization name — 64 characters maximum Organization unit — 64 characters maximum Contact email address — 64 characters maximum

7.3.2 Meters

Default settings and possible parameters - Meters

	Default setting	Possible parameters
Meters/Logs	Log measures every — 60s	Log measures every — 3600s maximum

7.3.3 Sensors alarm configuration

Default settings and possible parameters - Environment Alarm configuration

	Default setting	Possible parameters
Temperature	Enabled — No Low critical — 0°C/32°F Low warning — 10°C/50°F High warning — 70°C/158°F High critical — 80°C/176°F	Enabled — No/Yes low critical<low warning<high warning<high critical
Humidity	Enabled — No Low critical — 10% Low warning — 20% High warning — 80% High critical — 90%	Enabled — No/Yes 0%<low critical<low warning<high warning<high critical<100%

Dry contacts	Enabled — No Alarm severity – Warning	Enabled — No/Yes Alarm severity – Info/Warning/Critical
--------------	--	--

7.3.4 User profile

Default settings and possible parameters - User profile

	Default setting	Possible parameters
Profile	Account details: <ul style="list-style-type: none"> • Full name — Administrator • Email — blank • Phone — blank • Organization — blank Preferences: <ul style="list-style-type: none"> • Language — English • Date format — MM-DD-YYYY • Time format — hh:mm:ss (24h) • Temperature — °C (Celsius) 	Account details: <ul style="list-style-type: none"> • Full name — 128 characters maximum • Email — 128 characters maximum • Phone — 64 characters maximum • Organization — 128 characters maximum Preferences: <ul style="list-style-type: none"> • Language — English, French, German, Italian, Japanese, Russian, Simplified Chinese, Spanish, Traditional Chinese • Date format — MM-DD-YYYY / YYYY-MM-DD / DD-MM-YYY / DD.MM.YYY / DD/MM/YYY / DD MM YYYY • Time format — hh:mm:ss (24h) / hh:mm:ss (12h) • Temperature — °C (Celsius)/°F (Fahrenheit)

7.4 Access rights per profiles

7.4.1 Home

	Administrator	Operator	Viewer
Home	✓	✓	✓

7.4.2 Meters

	Administrator	Operator	Viewer
Meters	✓	✓	✓
Battery health: Launch test/Abort	✓	✓	✗
Logs configuration	✓	✓	✗

7.4.3 Controls

	Administrator	Operator	Viewer
Control	✓	✓	✗

7.4.4 Protection

	Administrator	Operator	Viewer
Protection/Scheduled shutdowns	✓	✓	✗

	Administrator	Operator	Viewer
Protection/Agent list	✓	✓	✗

	Administrator	Operator	Viewer
Protection/Agent settings	✓	✓	✗

	Administrator	Operator	Viewer
Protection/Sequence	✓	✓	✗

7.4.5 Environment

	Administrator	Operator	Viewer
Environment/Commissioning	✓	✓	✗
Environment/Status	✓	✓	✓

	Administrator	Operator	Viewer
Environment/Alarm configuration	✓	✓	✗

	Administrator	Operator	Viewer
Environment/Information	✓	✓	✓

7.4.6 Settings

	Administrator	Operator	Viewer
General	✓	✗	✗

	Administrator	Operator	Viewer
Local users	✓	✗	✗

	Administrator	Operator	Viewer
Remote users	✓	✗	✗

	Administrator	Operator	Viewer
Network & Protocols	✓	✗	✗

	Administrator	Operator	Viewer
SNMP	✓	✗	✗

	Administrator	Operator	Viewer
--	---------------	----------	--------

Industrial protocols/Modbus*	✓	✗	✗
Industrial protocols/BACnet*	✓	✗	✗

*for INDGW only

	Administrator	Operator	Viewer
Certificate	✓	✗	✗

7.4.7 Maintenance

	Administrator	Operator	Viewer
System information	✓	✓	✓

	Administrator	Operator	Viewer
Firmware	✓	✗	✗

	Administrator	Operator	Viewer
Services	✓	✗	✗

	Administrator	Operator	Viewer
Resources	✓	✓	✓

	Administrator	Operator	Viewer
System logs	✓	✗	✗

7.4.8 Legal information

	Administrator	Operator	Viewer
Legal information	✓	✓	✓

7.4.9 Alarms

	Administrator	Operator	Viewer
--	---------------	----------	--------

Alarm list	✓	✓	✓
Export	✓	✓	✓
Clear	✓	✓	✗

7.4.10 User profile

	Administrator	Operator	Viewer
User profile	✓	✓	✓

7.4.11 Contextual help

	Administrator	Operator	Viewer
Contextual help	✓	✓	✓
Full documentation	✓	✓	✓

7.4.12 CLI commands

	Administrator	Operator	Viewer
get release info	✓	✓	✓

	Administrator	Operator	Viewer
history	✓	✓	✓

	Administrator	Operator	Viewer
ldap-test	✓	✗	✗

	Administrator	Operator	Viewer
logout	✓	✓	✓

	Administrator	Operator	Viewer
maintenance	✓	✗	✗

	Administrator	Operator	Viewer
modbus_message_display*	✓	✗	✗

*for INDGW only

	Administrator	Operator	Viewer
modbus_statistics*	✓	✗	✗

*for INDGW only

	Administrator	Operator	Viewer
netconf	✓	✓ (read-only)	✓ (read-only)

	Administrator	Operator	Viewer
ping	✓	✗	✗
ping6	✓	✗	✗

	Administrator	Operator	Viewer
reboot	✓	✗	✗

	Administrator	Operator	Viewer
save_configuration	✓	✗	✗
restore_configuration	✓	✗	✗

	Administrator	Operator	Viewer
sanitize	✓	✗	✗

	Administrator	Operator	Viewer
ssh-keygen	✓	✗	✗

	Administrator	Operator	Viewer
time	✓	✓ (read-only)	✓ (read-only)

	Administrator	Operator	Viewer
traceroute	✓	✗	✗
traceroute6	✓	✗	✗

	Administrator	Operator	Viewer
whoami	✓	✓	✓

	Administrator	Operator	Viewer
email-test	✓	✗	✗

	Administrator	Operator	Viewer
systeminfo_statistics	✓	✓	✓

	Administrator	Operator	Viewer
certificates	✓	✗	✗

7.5 List of event codes

To get access to the Alarm log codes or the System log codes for email subscription, see sections below:

7.5.1 System log codes



To retrieve System logs, navigate to [Contextual help>>>Maintenance>>>System logs](#) section and press the **Download System logs** button.



Below codes are the one to be used to add "Exceptions on events notification" on email sending configurations. Some zeros maybe added in front of the code when displayed in emails or logs.

7.5.1.1 Critical

Code	Severity	Log message	File
0801000	Alert	User account - admin password reset to default	logAccount.csv
0E00400	Critical	The [selfsign/PKI] signed certificate of the <service> server is not valid	logSystem.csv
0A00700	Error	Network module file system integrity corrupted <f/w: xx.yy.zzzz>	logUpdate.csv

0000D00	Error	Card reboot due to database error	logSystem.csv
0700200	Error	Failed to start execution of script "<script description>". Client not registered. (<script uuid>)	logSystem.csv
0700400	Error	Execution of script "<script description>" failed with return code: <script return code>. (<script uuid>)	logSystem.csv
0700500	Error	Execution of script "<script description>" timeout! (<script uuid>)	logSystem.csv
0700700	Alert	Failed to prepare isolated environment for script execution. Protection service startup is aborted.	logSystem.csv

7.5.1.2 Warning

Code	Severity	Log message	File
0A00200	Warning	Network module upgrade failed <f/w: xx.yy.zzzz>	logUpdate.csv
0A00A00	Warning	Network module bootloader upgrade failed <f/w: xx.yy.zzzz>	logUpdate.csv
0B00500	Warning	RTC battery cell low	logSystem.csv
0E00200	Warning	New [self/PKI] signed certificate [generated/imported] for <service> server	logSystem.csv
0E00300	Warning	The [self/PKI] signed certificate of the <service> server will expires in <X> days	logSystem.csv
0800700	Warning	User account - password expired	logAccount.csv
0800900	Warning	User account- locked	logAccount.csv
0C00100	Warning	Unable to send email: Smtip server is unknown	logSystem.csv
0C00200	Warning	Unable to send email: Authentication method is not supported	logSystem.csv
0C00300	Warning	Unable to send email: Authentication error	logSystem.csv
0C00500	Warning	Unable to send email: Certificate Authority not recognized	logSystem.csv
0C00600	Warning	Unable to send email: Secure connection required	logSystem.csv
0C00800	Warning	Unable to send email: Unknown error	logSystem.csv
0C00B00	Warning	Unable to send email: Recipient not specified	logSystem.csv
0F01300	Warning	Card reboot due to Device FW upgrade	logSystem.csv
1000F00	Warning	<feature> settings partial restoration	logSystem.csv
1001000	Warning	<feature> settings restoration error	logSystem.csv
1000C00	Warning	Settings partial restoration	logSystem.csv
1000D00	Warning	Settings restoration error	logSystem.csv

7.5.1.3 Info

Code	Severity	Log message	File
0300D00	Notice	User action - sanitization launched	logSystem.csv
0A00500	Notice	Network module sanitized	logUpdate.csv
0A00900	Notice	Network module bootloader upgrade success <f/w: xx.yy.zzzz>	logUpdate.csv
0A00B00	Notice	Network module bootloader upgrade started <f/w: xx.yy.zzzz>	logUpdate.csv
0A00C00	Notice	Periodic system integrity check started	logUpdate.csv
0B00100	Notice	Time manually changed	logSystem.csv
0B00700	Notice	NTP sever not available <NTP server address>	logSystem.csv
0900100	Notice	Session - opened	logSession.csv
0900200	Notice	Session - closed	logSession.csv
0900300	Notice	Session - invalid token	logSession.csv
0900400	Notice	Session - authentication failed	logSession.csv
0300F00	Notice	User action - network module admin password reset switch activated	logSystem.csv
0E00500	Notice	[Certificate authority/ Client certificate] <id> is added for <service>	logSystem.csv
0E00600	Notice	[Certificate authority/ Client certificate] <id> is revoked for <service>	logSystem.csv
0700100	Info	Start execution of script "<script description>". (<script uuid>)	logSystem.csv
0700300	Info	Execution of script "<script description>" succeeded. (<script uuid>)	logSystem.csv
0700600	Info/Notice/ Error/Debug	<Script execution log message>	logSystem.csv
0800100	Notice	User account - created <user account id>	logAccount.csv
0800200	Notice	User account - deleted <user account id>	logAccount.csv
0800400	Notice	User account - name changed <user account id>	logAccount.csv
0800600	Notice	User account - password changed	logAccount.csv
0800800	Notice	User account- password reset <user account id>	logAccount.csv
0800A00	Notice	User account- unlocked	logAccount.csv
0800B00	Notice	User account - activated <user account id>	logAccount.csv
0800C00	Notice	User account - deactivated <user account id>	logAccount.csv
0900D00	Notice	<user> connected into interactive CLI with session id XXXXXX	logSession.csv
0900E00	Notice	<user> disconnected from interactive CLI with session id XXXXXX	logSession.csv

0900F00	Notice	<user> doesn't have access to CLI - CLI session id XXXXXX	logSession.csv
0901000	Notice	<user> connected and executes remote command <command> into the CLI - CLI session id XXXXXX	logSession.csv
0901100	Notice	<user> finished executing remote command <command> into the CLI - CLI session id XXXXXX	logSession.csv
0901200	Notice	<user> connection rejected - CLI session id XXXXXX	logSession.csv
0901300	Notice	<user> disconnected from interactive CLI with session id XXXXXX due to session timeout	logSession.csv
0901400	Notice	<user> disconnected from interactive CLI with session id XXXXXX due to concurrent connection with session id XXXXXX	logSession.csv
0100C00	Notice	Syslog is started	logSystem.csv
0100B00	Notice	Syslog is stopping	logSystem.csv
0100D00	Notice	Network module is booting	logSystem.csv
0100E00	Notice	Network module is operating	logSystem.csv
0100F00	Notice	Network module is starting shutdown sequence	logSystem.csv
0101000	Notice	Network module is ending shutdown sequence	logSystem.csv
0101400	Notice	Network module shutdown requested	logSystem.csv
0101500	Notice	Network module reboot requested	logSystem.csv
0100200	Notice	<nb alarms> alarms exported and flushed	logSystem.csv
0A00100	Info	Network module upgrade success <f/w: xx.yy.zzzz>	logUpdate.csv
0A00300	Info	Network module upgrade started	logUpdate.csv
0A00600	Info	Network module file system integrity OK <f/w: xx.yy.zzzz>	logUpdate.csv
0B00300	Info	Time with NTP synchronized	logSystem.csv
0B00600	Info	Time settings changed	logSystem.csv
0B01100	Info	Time reset to last known date: "date"	logSystem.csv
0C00F00	Info	Test email	
1000100	Info	Settings saving requested	logSystem.csv
1000200	Info	<feature> settings saved	logSystem.csv
1000A00	Info	Settings restoration requested	logSystem.csv
1000E00	Info	<feature> settings restoration success	logSystem.csv
1000B00	Info	Settings restoration success	logSystem.csv
0301500	Notice	Sanitization switch changed	logSystem.csv
0A01600	Notice	Major version downgrade	logUpdate.csv

List of event codes

0D00800	Notice	DHCP client script called with <script parameters>	logSystem.csv
0D00900	Notice	IPv4 configuration changed to <ipsv4_address>	logSystem.csv
0D01000	Notice	IPv6 configuration changed to <ipsv6_address>	logSystem.csv



Event with code 0700600 is used within shutdown script. The severity may vary according to the event context.

7.5.2 UPS(HID) alarm log codes



This table applies to all UPS except to the 9130 UPS.



To retrieve Alarm logs, navigate to [Contextual help>>>Alarms](#) section and press the **Download alarms** button.



Below codes are the one to be used to add "Exceptions on events notification" on email sending configurations. Some zeros maybe added in front of the code when displayed in emails or logs.

7.5.2.1 Critical

Code	Severity	Active message	Non-active message	Advice
002	Critical	Internal failure	End of internal failure	Service required
004	Critical	Temperature alarm	Temperature OK	Check air conditioner
100	Critical	Rectifier fuse fault	Rectifier fuse OK	Service required
105	Critical	Input AC module failure	Input AC module OK	Service required
207	Critical	Bypass AC module failure	Bypass AC module OK	-
208	Critical	Bypass overload	No bypass overload	-
305	Critical	Rectifier failure	Rectifier OK	Service required
306	Critical	Rectifier overload	Rectifier OK	Reduce output load
308	Critical	Rectifier short circuit	Rectifier OK	Reduce output load
400	Critical	DCDC converter failure	DCDC converter OK	Service required
500	Critical	Battery charger fault	Battery charger OK	Service required
607	Critical	Battery test failed	Battery test OK	Check battery
60D	Critical	No battery	Battery present	Check battery
61B	Critical	Battery BMS fault	Battery BMS OK	Check battery
629	Critical	Battery voltage low critical	Battery voltage OK	Check battery
62B	Critical	Battery voltage high critical	Battery voltage OK	Check battery
62D	Critical	Battery charge current low critical	Battery charge current OK	Check battery
62F	Critical	Battery charge current high critical	Battery charge current OK	Check battery
631	Critical	Battery discharge current low critical	Battery discharge current OK	Check battery
633	Critical	Battery discharge current high critical	Battery discharge current OK	Check battery

635	Critical	Battery temperature low critical	Battery temperature OK	Check battery
637	Critical	Battery temperature high critical	Battery temperature OK	Check battery
63E	Critical	Battery fault	Battery OK	Check battery
704	Critical	Inverter internal failure	UPS OK	Service required
705	Critical	Inverter overload	No power overload	Reduce output load
706	Critical	Temperature alarm	Temperature OK	Check air conditioner
70B	Critical	Inverter short circuit	End of inverter short circuit	Service required
805	Critical	Output short circuit	Output OK	Reduce output load
811	Critical	Parallel negative power	Parallel power OK	Reduce output load
815	Critical	Calibration fault	Calibration OK	Service required
81E	Critical	Load unprotected	Load protected	-

7.5.2.2 Warning

Code	Severity	Active message	Non-active message	Advice
001	Warning	On battery	No more on battery	-
007	Warning	Fan fault	Fan OK	Service required
00B	Warning	Parallel UPS redundancy lost	Parallel UPS redundancy OK	Reduce output load
00E	Warning	Parallel UPS communication lost	Parallel UPS communication OK	Service required
00F	Warning	Parallel UPS not compatible	Parallel UPS compatibility OK	Service required
010	Warning	UPS power supply fault	UPS power supply OK	Service required
011	Warning	Parallel UPS protection lost	Parallel UPS protection OK	Reduce output load
012	Warning	Parallel UPS measure inconsistent	Parallel UPS measure OK	Service required
103	Warning	Utility breaker open	Utility breaker closed	-
104	Warning	Input AC frequency out of range	Input AC frequency in range	-
106	Warning	Input AC not present	Input AC present	-
107	Warning	Input bad wiring	Input wiring OK	Check input wiring
108	Warning	Input AC voltage out of range (-)	Input AC voltage in range	-
109	Warning	Input AC voltage out of range (+)	Input AC voltage in range	-
110	Warning	Building alarm (through dry contact)	Building alarm OK	-
11F	Warning	Building alarm (through Network module)	Building alarm OK	-

10A	Warning	Input AC unbalanced	End of input AC unbalanced	-
200	Warning	Bypass phase out range	Bypass phase in range	-
201	Warning	Bypass not available	Bypass available	Service required
202	Warning	Bypass thermal overload	Bypass thermal OK	Reduce output load
203	Warning	Bypass temperature alarm	Bypass temperature OK	Check air conditioner
204	Warning	Bypass breaker open	Bypass breaker closed	-
205	Warning	Bypass mode	No more on bypass	-
206	Warning	Bypass frequency out of range	Bypass frequency in range	-
209	Warning	Bypass voltage out of range	Bypass voltage in range	-
20A	Warning	Bypass AC over voltage	End of bypass AC over voltage	-
20B	Warning	Bypass AC under voltage	End of bypass AC under voltage	-
20C	Warning	Bypass bad wiring	Bypass wiring OK	Check bypass wiring
300	Warning	DC bus + too high	DC bus + voltage OK	Service required
301	Warning	DC bus - too high	DC bus - voltage OK	Service required
302	Warning	DC bus + too low	DC bus + voltage OK	Service required
303	Warning	DC bus - too low	DC bus - voltage OK	Service required
304	Warning	DC bus unbalanced	DC bus OK	Service required
501	Warning	Charger temperature alarm	Charger temperature OK	Service required
502	Warning	Max charger voltage	Charger voltage OK	Service required
503	Warning	Min charger voltage	Charger voltage OK	Service required
600	Warning	Battery fuse fault	Battery fuse OK	Service required
602	Warning	Battery fuse fault	Battery fuse OK	Service required
604	Warning	Battery low state of charge	Battery state of charge OK	-
605	Warning	Battery temperature alarm	Battery temperature OK	Service required
606	Warning	Battery breaker open	Battery breaker closed	Service required
610	Warning	Battery low voltage	Battery voltage OK	Check battery
613	Warning	Battery voltage too high	Battery voltage OK	Check battery
616	Warning	Battery voltage unbalanced	Battery voltage OK	Check battery
61C	Warning	Communication with battery lost	Communication with battery recovered	Check battery
61E	Warning	At least one breaker in battery is open	All battery breakers are closed	Check battery

List of event codes

61F	Warning	Battery State Of Charge below limit	Battery State Of Charge OK	-
620	Warning	Battery State Of Health below limit	Battery State Of Health OK	Check battery
628	Warning	Battery voltage low warning	Battery voltage OK	Check battery
62A	Warning	Battery voltage high warning	Battery voltage OK	Check battery
62C	Warning	Battery charge current low warning	Battery charge current OK	Check battery
62E	Warning	Battery charge current high warning	Battery charge current OK	Check battery
630	Warning	Battery discharge current low warning	Battery discharge current OK	Check battery
632	Warning	Battery discharge current high warning	Battery discharge current OK	Check battery
634	Warning	Battery temperature low warning	Battery temperature OK	Check battery
636	Warning	Battery temperature high warning	Battery temperature OK	Check battery
638	Warning	Battery BMS failure	Battery BMS OK	Check battery
639	Warning	Battery temperature unbalanced	Battery temperature OK	Check battery
63D	Warning	Battery warning	Battery OK	Check battery
700	Warning	Inverter limitation	No current limitation	Reduce output load
701	Warning	Inverter fuse fault	Inverter fuse OK	Service required
70A	Warning	Inverter thermal overload	No power overload	Reduce output load
70C	Warning	Inverter voltage too low	Inverter voltage OK	Service required
70D	Warning	Inverter voltage too high	Inverter voltage OK	Service required
801	Warning	Load not powered	Load powered	-
803	Warning	Output breaker open	Output breaker closed	-
806	Warning	Emergency power OFF	No emergency OFF	-
808	Warning	Power overload	No power overload	Reduce output load
80D	Warning	Internal configuration failure	Internal configuration OK	Service required
80E	Warning	Overload pre-alarm	No overload pre-alarm	Reduce output load
810	Warning	Overload alarm	No overload	Reduce output load
814	Warning	Firmware watchdog reset	Firmware watchdog OK	Service required
816	Warning	Compatibility failure	Compatibility OK	Service required
817	Warning	Output over current	No output over current	Reduce output load
818	Warning	Output frequency out of range	Output frequency in range	Service required

819	Warning	Output voltage too high	Output voltage OK	Service required
81A	Warning	Output voltage too low	Output voltage OK	Service required
81B	Warning	UPS Shutoff requested	End of UPS shutoff requested	Service required
81D	Warning	Load not powered	Load protected	-
900	Warning	Maintenance bypass	Not on maintenance bypass	-
901	Warning	Maintenance bypass breaker closed	Maintenance bypass breaker open	-
B01	Warning	Batteries are aging. Consider replacement	Batteries aging condition cleared	-

7.5.2.3 Info

Code	Severity	Active message	Non-active message	Advice
005	Info	Communication lost (with UPS)	Communication recovered (with UPS)	Service required
009	Info	On high efficiency / On ESS mode	High efficiency disabled / ESS disabled	-
013	Info	Upgrading: limited communication	End of upgrade mode	-
101	Info	On AVR (Boost)	End of AVR (Boost)	-
102	Info	On AVR (Buck)	End of AVR (Buck)	-
603	Info	Battery discharging	End of UPS battery discharge	-
63C	Info	Battery information	Battery OK	-
A00	Info	Group 1 is OFF	Group 1 is ON	-
A01	Info	Group 2 is OFF	Group 2 is ON	-
A0F	Info	Group is OFF	Group is ON	-

7.5.2.4 Good



Alarms with a severity set as Good are not taken into account into the counter of active alarms.

Code	Severity	Active message
60E	Good	UPS external battery set as "No battery"
826	Good	Load powered

7.5.3 UPS(XCP) alarm log codes



Use this table for 9130, 9x55, 9395P, BladeUPS.



To retrieve Alarm logs, navigate to [Contextual help](#)>>>[Alarms](#) section and press the **Download alarms** button.



Below codes are the one to be used to add "Exceptions on events notification" on email sending configurations. Some zeros maybe added in front of the code when displayed in emails or logs.

7.5.3.1 Critical

Code	Severity	Active message	Non-active message	Advice
2002	Critical	Inverter AC frequency out of range	Inverter AC frequency in range	-
2012	Critical	Emergency power OFF	No emergency OFF	-
2020	Critical	Bypass temperature alarm	Bypass temperature OK	-
2022	Critical	Charger power supply tripped	Charger power supply no longer tripped	-
2024	Critical	Inverter Temperature too high	Inverter Temperature OK	-
2026	Critical	Rectifier current too high	Rectifier OK	-
2030	Critical	Rectifier failure	Rectifier current OK	-
2031	Critical	Inverter internal failure	UPS OK	-
2032	Critical	Battery breaker failure	Battery breaker OK	-
2033	Critical	Automatic bypass breaker failure	Automatic bypass breaker OK	-
2034	Critical	Battery charger fault	Battery charger OK	-
2036	Critical	Bypass AC static switch failure	Bypass AC static switch OK	-
2246	Critical	Neutral current limitation	Neutral current OK	-
2048	Critical	Inverter Start failure	Inverter Start OK	-
2051	Critical	Battery ground fault	Battery ground OK	-
2053	Critical	Non volatile memory failure	Non volatile memory OK	-
2055	Critical	UPS shutdown imminent	UPS shutdown no longer imminent	-
2056	Critical	Battery low state of charge	Battery state of charge OK	-
2058	Critical	Output short circuit	Output OK	-
2064	Critical	Rectifier self test failed	Rectifier self test OK	-
2068	Critical	Battery voltage too high	Battery voltage OK	-

2070	Critical	UPS power supply fault	UPS power supply OK	-
2073	Critical	Temperature too high	Temperature OK	-
2075	Critical	Rectifier overload	Rectifier OK	-
2076	Critical	Rectifier Offline due to overtemperature	Rectifier no longer tripped	-
2077	Critical	Input AC module failure	Input AC module OK	-
2079	Critical	Inverter self test failed	Inverter self test OK	-
2089	Critical	Output voltage DC offset too high	Output voltage DC offset OK	-
2111	Critical	Inverter Offline due to overtemperature	Inverter no longer tripped	-
2112	Critical	DC/DC converter failure	DC/DC converter OK	-
2116	Critical	Charger voltage too low	Charger voltage OK	-
2126	Critical	Battery totally discharged	Battery no longer totally discharged	-
2133	Critical	Loss of Sync bus	Sync bus recovered	-
2149	Critical	Battery needs service	Battery OK	-
2157	Critical	Output breaker failure	Output breaker OK	-
2165	Critical	Output phase 1 extreme overload	Output phase 1 no extreme overload	-
2166	Critical	Output phase 2 extreme overload	Output phase 2 no extreme overload	-
2167	Critical	Output phase 3 extreme overload	Output phase 3 no extreme overload	-
2186	Critical	Emergency transfer to bypass	Back from bypass	-
2188	Critical	Bypass AC module failure	Bypass AC module OK	-
2191	Critical	Battery fault	Battery OK	Check battery
2192	Critical	Fuse fault	Fuse OK	-
2193	Critical	Fan fault	Fan OK	-
2195	Critical	Backfeed bypass contactor failure	Backfeed bypass contactor OK	-
2199	Critical	Battery not present	Battery present	Check battery
2200	Critical	Temperature out of range	Temperature in range	-
2201	Critical	Transformer Temperature too high	Transformer Temperature OK	-
2217	Critical	Utility input breaker failure	Utility input breaker OK	-
2220	Critical	UPS module taken out of parallel system	UPS module back on parallel system	-
2223	Critical	Rectifier over temperature	Rectifier temperature OK	-

2229	Critical	At least one critical alarm active	No critical alarm active	-
2238	Critical	Inverter phases out of sequence	Inverter phases wired OK	-
2240	Critical	External CAN network fault	External CAN network OK	-
2242	Critical	Inverter breaker failure	Inverter breaker OK	-
2249	Critical	Rectifier over temperature tripped	Rectifier temperature OK	-
2259	Critical	Rectifier short circuit	Rectifier OK	-
2260	Critical	Rectifier short circuit	Rectifier OK	-
2261	Critical	Rectifier short circuit	Rectifier OK	-
2323	Critical	Inverter overload	No power overload	-
2324	Critical	Inverter short circuit	End of inverter short circuit	-
2325	Critical	Bypass overload	No bypass overload	-
2328	Critical	Bypass thermal overload	Bypass thermal OK	-
2364	Critical	Internal failure	End of internal failure	-
2365	Critical	Ground fault	Ground OK	-
2380	Critical	Output phase 1 excessive overload	Output phase 1 no excessive overload	-
2381	Critical	Output phase 2 excessive overload	Output phase 2 no excessive overload	-
2382	Critical	Output phase 3 excessive overload	Output phase 3 no excessive overload	-
2386	Critical	Major alarm condition that makes UPS need service	No major alarm condition	-
2387	Critical	Battery voltage low	Battery voltage no longer low	-
2392	Critical	Automatic bypass static switch current too high	Automatic bypass static switch current OK	-
2402	Critical	Parallel UPS not compatible	Parallel UPS compatibility OK	-

7.5.3.2 Warning

Code	Severity	Active message	Non-active message	Advice
2000	Warning	Inverter voltage too high	Inverter voltage OK	-
2001	Warning	Inverter voltage too low	Inverter voltage OK	-
2003	Warning	Bypass AC over voltage	End of bypass AC over voltage	-
2004	Warning	Bypass AC under voltage	No Bypass AC under voltage	-

2005	Warning	Bypass frequency out of range	Bypass frequency in range	-
2006	Warning	Input AC voltage out of range (+)	Input AC voltage in range	-
2007	Warning	Input AC voltage out of range (-)	Input AC voltage in range	-
2008	Warning	Input AC frequency out of range	Input AC frequency in range	-
2009	Warning	Output voltage too high	Output voltage OK	-
2010	Warning	Output voltage too low	Output voltage OK	-
2011	Warning	Output frequency out of range	Output frequency in range	-
2012	Warning	Emergency power OFF	No emergency OFF	-
2021	Warning	Charger over temperature	Charger temperature OK	-
2023	Warning	Charger over voltage or current	Charger voltage or current OK	-
2025	Warning	Power overload	No power overload	-
2027	Warning	Inverter output current too high	Inverter output current OK	-
2028	Warning	DC bus voltage too high	DC bus voltage OK	-
2029	Warning	DC bus voltage too low	DC bus voltage OK	-
2047	Warning	Battery discharge current too high	Battery discharge current OK	-
2056	Warning	Battery voltage or energy too low	Battery voltage or energy OK	-
2057	Warning	On battery	No more on battery	-
2063	Warning	Internal communication failure	Internal communication OK	-
2067	Warning	Input AC not present	Input AC present	-
2075	Warning	Rectifier input or output over current	Rectifier current OK	-
2102	Warning	Inverter L1 current too high	Inverter L1 current OK	-
2103	Warning	Inverter L2 current too high	Inverter L2 current OK	-
2104	Warning	Inverter L3 current too high	Inverter L3 current OK	-
2105	Warning	Bypass available	Bypass not available	-
2106	Warning	Utility input breaker closed	Utility input breaker open	-
2107	Warning	Battery breaker open	Battery breaker closed	-
2108	Warning	Inverter breaker open	Inverter breaker closed	-
2109	Warning	Automatic bypass breaker open	Automatic bypass breaker closed	-
2112	Warning	DC/DC converter failure	DC/DC converter OK	-
2118	Warning	Input phases out of sequence	Input phases wired OK	-
2119	Warning	Bypass phases out of sequence	Bypass phases wired OK	-

List of event codes

2132	Warning	Parallel UPS redundancy lost	Parallel UPS redundancy OK	-
2137	Warning	Output breaker open	Output breaker closed	-
2142	Warning	Bypass source power not sufficient	Bypass source power OK	-
2143	Warning	On maintenance bypass	No more on maintenance bypass	-
2147	Warning	Firmware watchdog reset	Firmware watchdog OK	-
2159	Warning	Output phase 1 overload pre-alarm	Output phase 1 no overload pre-alarm	-
2160	Warning	Output phase 2 overload pre-alarm	Output phase 2 no overload pre-alarm	-
2161	Warning	Output phase 3 overload pre-alarm	Output phase 3 no overload pre-alarm	-
2162	Warning	Output phase 1 overload	Output phase 1 no overload	-
2163	Warning	Output phase 2 overload	Output phase 2 no overload	-
2164	Warning	Output phase 3 overload	Output phase 3 no overload	-
2168	Warning	Battery discharging	Battery no longer discharging	-
2169	Warning	On bypass	No longer on bypass	-
2170	Warning	Load not powered	Load powered	-
2176	Warning	Compatibility failure	Compatibility OK	-
2189	Warning	Load not powered	Load powered	-
2194	Warning	Input bad wiring	Input wiring OK	-
2206	Warning	UPS Shutdown requested	End of UPS shutdown requested	-
2208	Warning	Charger unable to charge battery	Charger can charge battery	-
2224	Warning	Internal configuration failure	Internal configuration OK	-
2231	Warning	DC bus unbalanced	DC bus OK	-
2251	Warning	Inverter contactor open	Inverter contactor closed	-
2252	Warning	Rectifier contactor open	Rectifier contactor closed	-
2254	Warning	Battery contactor open	Battery contactor closed	-
2255	Warning	Backfeed bypass contactor open	Backfeed bypass contactor closed	-
2259	Warning	Rectifier L1 current too high	Rectifier L1 current OK	-
2260	Warning	Rectifier L2 current too high	Rectifier L2 current OK	-
2261	Warning	Rectifier L3 current too high	Rectifier L3 current OK	-
2306	Warning	Bypass breaker open	Bypass breaker closed	-
2309	Warning	Output phases are rotated	Output phases wired OK	-
2322	Warning	Battery temperature too high	Battery temperature OK	-

2326	Warning	Bypass phase out range	Bypass phase in range	-
2327	Warning	Bypass voltage out of range	Bypass voltage in range	-
2342	Warning	Overload pre-alarm	No overload pre-alarm	-
2364	Warning	Internal failure	End of internal failure	-
2366	Warning	Bypass bad wiring	Bypass wiring OK	-
2369	Warning	Battery low state of charge	Battery state of charge OK	-
2384	Warning	Major alarm condition that makes UPS fail	No major alarm condition	-

7.5.3.3 Info

Code	Severity	Active message	Non-active message	Advice
2014	Info	Building alarm 6	No building alarm 6	-
2015	Info	Building alarm 5	No building alarm 5	-
2016	Info	Building alarm 4	No building alarm 4	-
2017	Info	Building alarm 3	No building alarm 3	-
2018	Info	Building alarm 2	No building alarm 2	-
2019	Info	Building alarm 1	No building alarm 1	-
2038	Info	Bypass AC sensor not calibrated	Bypass AC sensor OK	-
2039	Info	Input AC sensor not calibrated	Input AC sensor calibrated	-
2040	Info	Output AC sensor not calibrated	Output AC sensor calibrated	-
2041	Info	Inverter sensor not calibrated	Inverter sensor calibrated	-
2042	Info	DC bus sensor not calibrated	DC bus sensor calibrated	-
2043	Info	Output AC current sensor not calibrated	Output AC current sensor calibrated	-
2044	Info	Input AC current sensor not calibrated	Input AC current sensor calibrated	-
2045	Info	Battery current sensor not calibrated	Battery current sensor calibrated	-
2059	Info	Utility AC not present	Utility AC present	-
2063	Info	Internal communication failure	Internal communication OK	-
2121	Info	Parallel UPS internal failure	Parallel UPS OK	-
2130	Info	Charger current too high	Charger current OK	-

List of event codes

2135	Info	Charger not synchronized with input phase	Charger synchronized with input phase	-
2168	Info	Battery discharging	UPS battery no longer discharging	-
2185	Info	Automatic bypass breaker should be closed	Automatic bypass breaker closed	-
2196	Info	On AVR (Buck)	End of AVR (Buck)	-
2197	Info	On AVR (Boost)	End of AVR (Boost)	-
2202	Info	Ambient temperature is too Low	Ambient temperature is OK	-
2204	Info	Door or cover of the UPS open	Door or cover of the UPS closed	-
2211	Info	Modem connection fault	Modem connection OK	-
2227	Info	On high efficiency or ESS	No longer on High efficiency or ESS	-
2228	Info	At least one informational alarm active	No informational alarms active	-
2247	Info	Battery breaker should be closed	Battery breaker closed	-
2370	Info	Building alarm 7	Building alarm 7 OK	-
2371	Info	Building alarm 8	Building alarm 8 OK	-
2372	Info	Building alarm 9	Building alarm 9 OK	-
2383	Info	Condition to call user true	No condition to call user	-
2385	Info	Service scheduled	Service no longer scheduled	-

7.5.4 EMP alarm log codes



To retrieve Alarm logs, navigate to [Contextual help>>>Alarms](#) section and press the **Download alarms** button.



Below codes are the one to be used to add "Exceptions on events notification" on email sending configurations. Some zeros maybe added in front of the code when displayed in emails or logs.

7.5.4.1 Critical

Code	Severity	Active message	Non-active message	Advice
1201	Critical	Temperature is critically low	Temperature is back to low	-
1204	Critical	Temperature is critically high	Temperature is back to high	-
1211	Critical	Humidity is critically low	Humidity is back to low	-
1214	Critical	Humidity is critically high	Humidity is back to high	-

7.5.4.2 Warning

Code	Severity	Active message	Non-active message	Advice
1200	Warning	Communication lost	Communication recovered	-
1202	Warning	Temperature is low	Temperature is back to normal	-
1203	Warning	Temperature is high	Temperature is back to normal	-
1212	Warning	Humidity is low	Humidity is back to normal	-
1213	Warning	Humidity is high	Humidity is back to normal	-

7.5.4.3 With settable severity

Code	Severity	Active message	Non-active message	Advice
1221	Settable	Contact is active	Contact is back to normal	-

7.5.5 Network module alarm log codes



To retrieve Alarm logs, navigate to [Contextual help>>>Alarms](#) section and press the **Download alarms** button.



Below codes are the one to be used to add "Exceptions on events notification" on email sending configurations. Some zeros maybe added in front of the code when displayed in emails or logs.

7.5.5.1 Warning

7.5.5.1.1 Protection

Code	Severity	Active message	Non-active message	Advice
1032	Warning	Protection: immediate shutdown in progress	Protection: immediate shutdown completed	-
1053	Warning	Protection: communication lost with agent	Protection: communication recovered with agent	-

7.5.5.1.2 Alarms

Code	Severity	Active message	Non-active message	Advice
1303	Warning	Alarms: the number of alarms is too high and above 6 000	Alarms: the number of alarms is back to normal	2 000 alarms have been erased and saved in a backup file.

7.5.5.2 Info

7.5.5.2.1 Protection

Code	Severity	Active message	Non-active message	Advice
1016	Info	Protection: sequential shutdown scheduled	Protection: sequential shutdown canceled	-
1017	Info	Protection: sequential shutdown in progress	Protection: sequential shutdown completed	-
1054	Info	Protection: agent is in unknown state	Protection: agent is in service	-
1055	Info	Protection: agent is starting	Protection: agent is in service	-
1056	Info	Protection: agent is stopping	Protection: agent is in service	-
1057	Info	Protection: agent is stopped	Protection: agent is in service	-
1100	Info	Schedule: shutdown date reached	Schedule: shutdown initiated	-

7.5.5.2.2 Communication

Code	Severity	Active message	Non-active message	Advice
1300	Info	Communication: No device connected	Communication: Communication with the device is back	-
1301	Info	Communication: Device not supported	Communication: Communication with the device is back	-

7.5.5.2.3 Alarms

Code	Severity	Active message	Non-active message	Advice
1302	Info	Alarms: the number of alarms is high and above 5 000	Alarms: the number of alarms is back to normal	It is recommended to Export and Clear the alarm log.

7.6 SNMP traps

7.6.1 UPS Mib

7.6.1.1 IETF Mib-2 Ups traps

This information is for reference only.

Trap oid : .1.3.6.1.2.1.33.2.0.x	Description :
.1.3.6.1.2.1.33.2.0.1	Sent whenever the UPS transfers on battery, then sent every minutes until the UPS Comes back to AC Input.
.1.3.6.1.2.1.33.2.0.3	Sent whenever an alarm appears. The matching alarm oid is added as bound variables in the table below.
.1.3.6.1.2.1.33.2.0.4	Sent whenever an alarm disappears. The matching alarm oid is added as bound variables in the table below.

Alarm oid at : .1.3.6.1.2.1.33.1.6.3.x	Description when trap 3	Description when trap 4
.1.3.6.1.2.1.33.1.6.3.1	Battery test failed	Battery test OK
.1.3.6.1.2.1.33.1.6.3.2	Battery discharging	End of UPS battery discharge
.1.3.6.1.2.1.33.1.6.3.3	Low battery	Battery OK
.1.3.6.1.2.1.33.1.6.3.5	Temperature alarm	Temperature OK
.1.3.6.1.2.1.33.1.6.3.6	Input AC not present	Input AC present

Alarm oid at : .1.3.6.1.2.1.33.1.6.3.x	Description when trap 3	Description when trap 4
.1.3.6.1.2.1.33.1.6.3.8	Power overload	No power overload
.1.3.6.1.2.1.33.1.6.3.9	Bypass mode	No more on bypass
.1.3.6.1.2.1.33.1.6.3.10	Bypass not available	Bypass available
.1.3.6.1.2.1.33.1.6.3.13	Battery charger fault	Battery charger OK
.1.3.6.1.2.1.33.1.6.3.14	Not powered	Powered (Protected or Not protected)
.1.3.6.1.2.1.33.1.6.3.16	Fan fault	Fan OK
.1.3.6.1.2.1.33.1.6.3.17	Battery fuse fault Rectifier fuse fault Inverter fuse fault	Battery fuse OK Rectifier fuse OK Inverter fuse OK
.1.3.6.1.2.1.33.1.6.3.18	Internal failure	End of internal failure
.1.3.6.1.2.1.33.1.6.3.20	Communication lost	Communication recovered
.1.3.6.1.2.1.33.1.6.3.23	Shutdown imminent	Shutdown canceled

7.6.1.2 Xups Mib traps

This information is for reference only.

Trap oid : .1.3.6.1.4.1.534.1.11.4.1.0.x	Trap message at oid : .1.3.6.1.4.1.534.1.11.3.0
.1.3.6.1.4.1.534.1.11.4.1.0.3	Battery discharging
.1.3.6.1.4.1.534.1.11.4.1.0.4	Battery low
.1.3.6.1.4.1.534.1.11.4.1.0.5	No more on battery
.1.3.6.1.4.1.534.1.11.4.1.0.6	Battery OK
.1.3.6.1.4.1.534.1.11.4.1.0.7	Power overload
.1.3.6.1.4.1.534.1.11.4.1.0.8	Internal failure
.1.3.6.1.4.1.534.1.11.4.1.0.10	Inverter internal failure
.1.3.6.1.4.1.534.1.11.4.1.0.11	Bypass mode
.1.3.6.1.4.1.534.1.11.4.1.0.12	Bypass not available
.1.3.6.1.4.1.534.1.11.4.1.0.13	Load not powered
.1.3.6.1.4.1.534.1.11.4.1.0.14	On battery
.1.3.6.1.4.1.534.1.11.4.1.0.15	Building alarm through input dry contact
.1.3.6.1.4.1.534.1.11.4.1.0.16	Shutdown imminent
.1.3.6.1.4.1.534.1.11.4.1.0.17	No more on bypass
.1.3.6.1.4.1.534.1.11.4.1.0.20	Breaker open

Trap oid :	Trap message at oid :
.1.3.6.1.4.1.534.1.11.4.1.0.x	.1.3.6.1.4.1.534.1.11.3.0
.1.3.6.1.4.1.534.1.11.4.1.0.23	Battery test failed
.1.3.6.1.4.1.534.1.11.4.1.0.26	Communication lost
.1.3.6.1.4.1.534.1.11.4.1.0.30	Sensor contact is active
.1.3.6.1.4.1.534.1.11.4.1.0.31	Sensor contact back to normal
.1.3.6.1.4.1.534.1.11.4.1.0.32	Parallel UPS redundancy lost
.1.3.6.1.4.1.534.1.11.4.1.0.33	Temperature alarm
.1.3.6.1.4.1.534.1.11.4.1.0.34	Battery charger fault
.1.3.6.1.4.1.534.1.11.4.1.0.35	Fan fault
.1.3.6.1.4.1.534.1.11.4.1.0.36	Fuse fault
.1.3.6.1.4.1.534.1.11.4.1.0.42	Sensor temperature is below/above critical threshold
.1.3.6.1.4.1.534.1.11.4.1.0.43	Sensor humidity is below/above critical threshold
.1.3.6.1.4.1.534.1.11.4.1.0.48	Maintenance bypass

7.6.2 Sensor Mib

7.6.2.1 Sensor Mib traps

This information is for reference only.

Trap oid :	Trap description
.1.3.6.1.4.1.534.6.8.1.x.x.x	
.1.3.6.1.4.1.534.6.8.1.1.0.1	Sent whenever the sensor count changes after a discovery or removing from the UI.
.1.3.6.1.4.1.534.6.8.1.1.0.2	Sent whenever one status of each sensor connected changes.
.1.3.6.1.4.1.534.6.8.1.2.0.1	Sent whenever one status of each temperature changes.
.1.3.6.1.4.1.534.6.8.1.3.0.1	Sent whenever one status of each humidity changes.
.1.3.6.1.4.1.534.6.8.1.4.0.1	Sent whenever one status of each digital input alarm changes.

7.7 CLI

CLI can be accessed through:

- SSH
- Serial terminal emulation (refer to section [Servicing the Network Management Module>>>Installing the Network Module>>>Accessing the card through serial terminal emulation](#)).

It is intended mainly for automated configuration of the network and time settings of the network card. It can also be used for troubleshooting and remote reboot/reset of the network interface in case the web user interface is not accessible.

Warning: Changing network parameters may cause the card to become unavailable remotely. If this happens it can only be reconfigured locally through USB.

7.7.1 Commands available

You can see this list anytime by typing in the CLI:

```
?
```

7.7.2 Contextual help

You can see this help anytime by typing in the CLI:

```
help
```

CONTEXT SENSITIVE HELP

[?] - Display context sensitive help. This is either a list of possible command completions with summaries, or the full syntax of the current command. A subsequent repeat of **this** key, when a command has been resolved, will display a detailed reference.

AUTO-COMPLETION

The following keys both perform auto-completion **for** the current command line. If the command prefix is not unique then the bell will ring and a subsequent repeat of the key will display possible completions.

[enter] - Auto-completes, syntax-checks then executes a command. If there is a syntax error then offending part of the command line will be highlighted and explained.

[space] - Auto-completes, or **if** the command is already resolved inserts a space.

MOVEMENT KEYS

[CTRL-A] - Move to the start of the line

[CTRL-E] - Move to the end of the line.

[up] - Move to the previous command line held in history.

[down] - Move to the next command line held in history.

[left] - Move the insertion point left one character.

[right] - Move the insertion point right one character.

DELETION KEYS

[CTRL-C] - Delete and abort the current line

[CTRL-D] - Delete the character to the right on the insertion point.

[CTRL-K] - Delete all the characters to the right of the insertion point.

[CTRL-U] - Delete the whole line.

[backspace] - Delete the character to the left of the insertion point.

ESCAPE SEQUENCES

!! - Substitute the last command line.

!N - Substitute the Nth command line (absolute as per 'history' command)

!-N - Substitute the command line entered N lines before (relative)

7.7.3 get release info

7.7.3.1 Description

Displays certain basic information related to the firmware release.

7.7.3.2 Help

```
get_release_info
-d Get current release date
-s Get current release sha1
-t Get current release time
-v Get current release version number
```

7.7.3.3 Specifics

7.7.3.4 Access rights per profiles

	Administrator	Operator	Viewer
get release info	✓	✓	✓

7.7.4 history

7.7.4.1 Description

Displays recent commands executed on the card.

7.7.4.2 Help

```
history
<cr> Display the current session's command line history (by default display
last 10 commands)
<Unsigned integer> Set the size of history list (zero means unbounded). Example 'history
6' display the 6 last command
```

7.7.4.3 Specifics

7.7.4.4 Access rights per profiles

	Administrator	Operator	Viewer
history	✓	✓	✓

7.7.5 logout

7.7.5.1 Description

Logout the current user.

7.7.5.2 Help

```
logout
<cr> logout the user
```

7.7.5.3 Specifics

7.7.5.4 Access rights per profiles

	Administrator	Operator	Viewer
logout	✓	✓	✓

7.7.6 maintenance

7.7.6.1 Description

Creates a maintenance report file which may be handed to the technical support.

7.7.6.2 Help

```
maintenance
<cr> Create maintenance report file.
-h, --help Display help page
```

7.7.6.3 Specifics

7.7.6.4 Access rights per profiles

	Administrator	Operator	Viewer
maintenance	✓	✗	✗

7.7.7 modbus_message_display



This section is only for the Modbus Network Module INDGW

7.7.7.1 Description

modbus_message_display restarts the server and displays Modbus message. This command allow you to verify that Modbus server is working as expected.

7.7.7.2 Help

```
modbus_message_display
--help Restart server and display modbus message
-h Restart server and display modbus message
```

7.7.7.3 Specifics

7.7.7.4 Access rights per profiles

	Administrator	Operator	Viewer
modbus_message_display*	✔	✘	✘

*for INDGW only

7.7.8 modbus_statistics

 This section is only for the Modbus Network Module INDGW

7.7.8.1 Description

modbus_statistics displays Modbus RTU and TCP status and server statistics:

- Bus character overrun count
- Bus frame error count
- Bus parity error count
- Buffer overrun count

- Bus message count
- Valid message count
- CRC error count

- Incoming message count
- Discarded message count
- Processed message count
- Success returned count
- Exception returned count

7.7.8.2 Help

```
modbus_statistics
Display modbus server statistics

-h, --help Display the help page.
-r, --reset Reset modbus server statistics.
```

The counter from A1.1 to A1.4 are reset only at startup of the server.

7.7.8.3 Specifics

7.7.8.4 Access rights per profiles

	Administrator	Operator	Viewer
modbus_statistics*	✓	✗	✗

*for INDGW only

7.7.9 netconf

7.7.9.1 Description

Tools to display or change the network configuration of the card.

7.7.9.2 Help

For Viewer and Operator profiles:

```
netconf -h
Usage: netconf [OPTION]...
Display network information and change configuration.

-h, --help          display help page
-l, --lan           display Link status and MAC address
-4, --ipv4         display IPv4 Mode, Address, Netmask and Gateway
-6, --ipv6         display IPv6 Mode, Addresses and Gateway
-d, --domain       display Domain mode, FQDN, Primary and Secondary DNS
```

For Administrator profile:

```
netconf -h
Usage: netconf [OPTION]...
Display network information and change configuration.
-h, --help          display help page
-l, --lan           display Link status and MAC address
-d, --domain       display Domain mode, FQDN, Primary and Secondary DNS
-4, --ipv4         display IPv4 Mode, Address, Netmask and Gateway
-6, --ipv6         display IPv6 Mode, Addresses and Gateway
Set commands are used to modify the settings.
-s, --set-lan <link speed>
Link speed values:
auto              Auto negotiation
10hf             10 Mbps - Half duplex
10ff             10 Mbps - Full duplex
100hf            100 Mbps - Half duplex
```

```

100ff      100 Mbps - Full duplex
1000ff     1.0 Gbps - Full duplex
-f, --set-domain hostname <hostname>    set custom hostname
-f, --set-domain <mode>
      Mode values:
      - set custom Network address, Netmask and Gateway:
        manual <domain name> <primary DNS> <secondary DNS>
      - automatically set Domain name, Primary and Secondary DNS
        dhcp
-i, --set-ipv4 <mode>
      Mode values:
      - set custom Network address, Netmask and Gateway
        manual <network> <mask> <gateway>
      - automatically set Network address, Netmask and Gateway
        dhcp
-x, --set-ipv6 <status>
      Status values:
      - enable IPv6
        enable
      - disable IPv6
        disable
-x, --set-ipv6 <mode>
      Mode values:
      - set custom Network address, Prefix and Gateway
        manual <network> <prefix> <gateway>
      - automatically set Network address, Prefix and Gateway
        router
Examples of usage:
-> Display Link status and MAC address
    netconf -l
-> Set Auto negotiation to Link
    netconf --set-lan auto
-> Set custom hostname
    netconf --set-domain hostname ups-00-00-00-00-00-00
-> Set Address, Netmask and Gateway
    netconf --set-ipv4 manual 192.168.0.1 255.255.255.0 192.168.0.2
-> Disable IPv6

```

7.7.9.3 Examples of usage

```

-> Display Link status and MAC address
    netconf -l
-> Set Auto negotiation to Link
    netconf -s auto
-> Set custom hostname
    netconf -f hostname ups-00-00-00-00-00-00
-> Set Address, Netmask and Gateway
    netconf -i manual 192.168.0.1 255.255.255.0 192.168.0.2
-> Disable IPv6
    netconf -6 disable

```

7.7.9.4 Specifics

7.7.9.5 Access rights per profiles

	Administrator	Operator	Viewer
netconf	✓	✓ (read-only)	✓ (read-only)

7.7.10 ping and ping6

7.7.10.1 Description

Ping and ping6 utilities are used to test network connection.

7.7.10.2 Help

ping

The ping utility uses the ICMP protocol's mandatory ECHO_REQUEST datagram to elicit an ICMP ECHO_RESPONSE from a host or gateway. ECHO_REQUEST datagrams ('`pings`') have an IP and ICMP header, followed by a '`struct timeval`' and then an arbitrary number of '`pad`' bytes used to fill out the packet.

```
-c          Specify the number of echo requests to be sent
-h          Specify maximum number of hops
<Hostname or IP> Host name or IP address
```

ping6

The ping6 utility uses the ICMP protocol's mandatory ECHO_REQUEST datagram to elicit an ICMP ECHO_RESPONSE from a host or gateway. ECHO_REQUEST datagrams ('`pings`') have an IP and ICMP header, followed by a '`struct timeval`' and then an arbitrary number of '`pad`' bytes used to fill out the packet.

```
-c          Specify the number of echo requests to be sent
<IPv6 address> IPv6 address
```

7.7.10.3 Specifics

7.7.10.4 Access rights per profiles

	Administrator	Operator	Viewer
ping	✓	✗	✗
ping6	✓	✗	✗

7.7.11 reboot

7.7.11.1 Description

Tool to Reboot the card.

7.7.11.2 Help

```
Usage: reboot [OPTION]
  <cr>                Reboot the card
  --help              Display help
  --withoutconfirmation Reboot the card without confirmation
```

7.7.11.3 Specifics

7.7.11.4 Access rights per profiles

	Administrator	Operator	Viewer
reboot	✓	✗	✗

7.7.12 save_configuration | restore_configuration

7.7.12.1 Description

Save_configuration and restore_configuration are using JSON format to save and restore certain part of the configuration of the card.

7.7.12.2 Help

```
save_configuration -h
save_configuration: print the card configuration in JSON format to standard output.
```

```
restore_configuration -h
restore_configuration: restore the card configuration from a JSON-formatted standard input.
```

7.7.12.3 Examples of usage

7.7.12.3.1 From a linux host:

Save over SSH: sshpass -p \$PASSWORD ssh \$USER@\$CARD_ADDRESS save_configuration -p \$PASSPHRASE > \$FILE

Restore over SSH: cat \$FILE | sshpass -p \$PASSWORD ssh \$USER@\$CARD_ADDRESS restore_configuration -p \$PASSPHRASE

7.7.12.3.2 From a Windows host:

Save over SSH: plink \$USER@\$CARD_ADDRESS -pw \$PASSWORD -batch save_configuration -p \$PASSPHRASE > \$FILE

Restore over SSH: type \$FILE | plink \$USER@\$CARD_ADDRESS -pw \$PASSWORD -batch restore_configuration -p \$PASSPHRASE
(Require plink tools from putty)

Where:

- \$USER is user name (the user shall have administrator profile)
- \$PASSWORD is the user password
- \$PASSPHRASE is any passphrase to encrypt/decrypt sensible data.
- \$CARD_ADDRESS is IP or hostname of the card
- \$FILE is a path to the JSON file (on your host computer) where the configuration is saved or restored.

7.7.12.4 Specifics

7.7.12.5 Access rights per profiles

	Administrator	Operator	Viewer
save_configuration	✓	✗	✗
restore_configuration	✓	✗	✗

7.7.13 sanitize

7.7.13.1 Description

Sanitize command to return card to factory reset configuration.

7.7.13.2 Access

- Administrator

7.7.13.3 Help

```

sanitize
-h, --help           Display help page
--withoutconfirmation Do factory reset of the card without confirmation
<cr>                Do factory reset of the card

```

7.7.13.4 Access rights per profiles

	Administrator	Operator	Viewer
sanitize	✓	✗	✗

7.7.14 ssh-keygen

7.7.14.1 Description

Command used for generating the ssh keys.

7.7.14.2 Help

```
ssh-keygen
-h, --help  Display help
<cr>      Renew SSH keys
```

7.7.14.3 Specifics

7.7.14.4 Access rights per profiles

	Administrator	Operator	Viewer
ssh-keygen	✓	✗	✗

7.7.15 time

7.7.15.1 Description

Command used to display or change time and date.

7.7.15.2 Help

For Viewer and Operator profiles:

```
time -h
Usage: time [OPTION]...
Display time and date.

-h, --help      display help page
-p, --print     display date and time in YYYYMMDDhhmmss format
```

For Administrator profile:

```
time -h
Usage: time [OPTION]...
Display time and date, change time and date.
-h, --help      display help page
-p, --print     display date and time in YYYYMMDDhhmmss format
-s, --set <mode>
Mode values:
- set date and time (format YYYYMMDDhhmmss)
  manual <date and time>
- set preferred and alternate NTP servers
  ntpmanual <preferred server> <alternate server>
- automatically set date and time
  ntpauto
Examples of usage:
-> Set date 2017-11-08 and time 22:00
time --set manual 201711082200
```

```
-> Set preferred and alternate NTP servers
time --set ntpmanual fr.pool.ntp.org de.pool.ntp.org
```

7.7.15.3 Examples of usage

```
-> Set date 2017-11-08 and time 22:00
time --set manual 201711082200
-> Set preferred and alternate NTP servers
time --set ntpmanual fr.pool.ntp.org de.pool.ntp.org
```

7.7.15.4 Specifics

7.7.15.5 Access rights per profiles

	Administrator	Operator	Viewer
time	✓	✓ (read-only)	✓ (read-only)

7.7.16 traceroute and traceroute6

7.7.16.1 Description

Traceroute and traceroute6 utilities are for checking the configuration of the network.

7.7.16.2 Help

```
traceroute
-h          Specify maximum number of hops
<Hostname or IP> Remote system to trace
```

```
traceroute6
-h          Specify maximum number of hops
<IPv6 address> IPv6 address
```

7.7.16.3 Specifics

7.7.16.4 Access rights per profiles

	Administrator	Operator	Viewer
traceroute	✓	✗	✗
traceroute6	✓	✗	✗

7.7.17 whoami

7.7.17.1 Description

whoami displays current user information:

- Username
- Profile
- Realm

7.7.17.2 Specifics

7.7.17.3 Access rights per profiles

	Administrator	Operator	Viewer
whoami	✓	✓	✓

7.7.18 email-test

7.7.18.1 Description

mail-test sends test email to troubleshoot SMTP issues.

7.7.18.2 Help

```

Usage: email-test <command> ...
Test SMTP configuration.

Commands:
  email-test -h, --help, Display help page

  email-test -r, --recipient <recipient_address>
  Send test email to the
  <recipient_address>      Email address of the recipient
    
```

7.7.18.3 Specifics

7.7.18.4 Access rights per profiles

	Administrator	Operator	Viewer
email-test	✓	✗	✗

7.7.19 systeminfo_statistics

7.7.19.1 Description

Displays the following system information usage:

1. CPU
 - a. usage : %
 - b. upSince : date since the system started
2. Ram
 - a. total: MB
 - b. free: MB
 - c. used: MB
 - d. tmpfs: temporary files usage (MB)
3. Flash
 - a. user data
 - i. total: MB
 - ii. free: MB
 - iii. used: MB

7.7.19.2 Help

```
systeminfo_statistics
    Display systeminfo statistics

-h, --help    Display the help page.
```

7.7.19.3 Specifics

7.7.19.4 Access rights per profiles

	Administrator	Operator	Viewer
systeminfo_statistics	✓	✓	✓

7.7.20 certificates

7.7.20.1 Description

Allows to manage certificates through the CLI.

7.7.20.2 Help

```
certificates <target> <action> <service_name>
<target> :
  - local
<action> :
  - print: provides a given certificate detailed information.
  - revoke: revokes a given certificate.
  - export: returns a given certificate contents.
```

```

- import: upload a given certificate for the server CSR. This will replace the CSR
with the certificate given.
- csr: get the server CSR contents. This will create the CSR if not already existing.
<service_name>: mqtt/syslog/webserver

```

7.7.20.3 Examples of usage

7.7.20.3.1 From a linux host:

print over SSH: sshpass -p \$PASSWORD ssh \$USER@\$CARD_ADDRESS certificates local print \$SERVICE_NAME

revoke over SSH: sshpass -p \$PASSWORD ssh \$USER@\$CARD_ADDRESS certificates local revoke \$SERVICE_NAME

export over SSH: sshpass -p \$PASSWORD ssh \$USER@\$CARD_ADDRESS certificates local export \$SERVICE_NAME

import over SSH: cat \$FILE | sshpass -p \$PASSWORD ssh \$USER@\$CARD_ADDRESS certificates local import \$SERVICE_NAME

csr over SSH: sshpass -p \$PASSWORD ssh \$USER@\$CARD_ADDRESS certificates local csr mqtt

7.7.20.3.2 From a Windows host: (plink tools from putty is required)

print over SSH: plink \$USER@\$CARD_ADDRESS -pw \$PASSWORD -batch certificates local print \$SERVICE_NAME

revoke over SSH: plink \$USER@\$CARD_ADDRESS -pw \$PASSWORD -batch certificates local revoke \$SERVICE_NAME

export over SSH: plink \$USER@\$CARD_ADDRESS -pw \$PASSWORD -batch certificates local export \$SERVICE_NAME

import over SSH: type \$FILE | plink \$USER@\$CARD_ADDRESS -pw \$PASSWORD -batch certificates local import \$SERVICE_NAME

csr over SSH: plink \$USER@\$CARD_ADDRESS -pw \$PASSWORD -batch certificates local csr mqtt

7.7.20.3.3 Where:

- \$USER is user name (the user shall have administrator profile)
- \$PASSWORD is the user password
- \$PASSPHRASE is any passphrase to encrypt/decrypt sensible data.
- \$CARD_ADDRESS is IP or hostname of the card
- \$FILE is a certificate file
- \$SERVICE_NAME is the name one of the following services : mqtt / syslog / webserver.

7.7.20.4 Specifics

7.7.20.5 Access rights per profiles

	Administrator	Operator	Viewer
certificates	✓	✗	✗

7.8 Legal information

This Network Module includes software components that are either licensed under various open source license, or under a proprietary license.

For more information, see to the legal Information link from the main user interface in the footer.

7.8.1 Availability of Source Code

The source code of open source components that are made available by their licensors may be obtained upon written express request by contacting network-m2-opensource@Eaton.com. Eaton reserves the right to charge minimal administrative costs, in compliance with the terms of the underlying open source licenses, when the situation requires.

7.8.2 Notice for Open Source Elements

This product includes software released under BSD or Apache v2 licenses, and developed by various projects, peoples and entities, such as, but not limited to:

- * the Regents of the University of California, Berkeley and its contributors,
- * the OpenEvidence Project,
- * Oracle and/or its affiliates,
- * Mike Bostock,
- * JS Foundation and other contributors,
- * 2011-2014 Novus Partners, Inc.

This product includes software developed by the OpenSSL Project for use in the OpenSSL Toolkit. (www.openssl.org/).

This product includes cryptographic software written by Eric Young (eay@cryptsoft.com).

This product includes software released under MIT license, and developed by various projects, peoples and entities, such as, but not limited to:

- * Google, Inc.,
- * the AngularUI Team
- * Lucas Galfasó
- * nerv
- * Angular
- * Konstantin Skipor
- * Filippo Oretti, Dario Andrei
- * The angular-translate team and Pascal Precht,
- * Twitter, Inc.
- * Zeno Rocha
- * Kristopher Michael Kowal and contributors
- * JS Foundation and other contributors
- * Jonathan Hieb
- * Mike Grabski
- * Sachin N.

This product includes contents released under Creative Commons Attribution 4.0, Creative Commons Attribution-ShareAlike 3.0 Unported and SIL Open Font License licenses, and created by:

- * IcoMoon
- * Dave Gandy
- * Stephen Hutchings and the Typicons team.

In order to access the complete and up to date copyright information, licenses, and legal disclaimers, see the Legal Information pages, available from the HTML user interface of the present product.

7.8.3 Notice for our proprietary (i.e. non-Open source) elements

Copyright © 2020 Eaton. This firmware is confidential and licensed under Eaton Proprietary License (EPL or EULA).

This firmware is not authorized to be used, duplicated, or disclosed to anyone without the prior written permission of Eaton.

Limitations, restrictions and exclusions of the Eaton applicable standard terms and conditions, such as its EPL and EULA, apply.

7.9 Acronyms and abbreviations

AC: Alternating current.

AVR: Automatic Voltage Regulation provides stable voltage to keep equipment running in the optimal range.

BBDM: Broadcast Management Device (BACnet).

BMS: A Battery Management System is any electronic system that manages li-ion battery.

bps: bit per second

BOM: In Syslog, placing an encoded Byte Order Mark at the start of a text stream can indicate that the text is Unicode and identify the encoding scheme used.

CA: Certificate Authority

CLI: Command Line Interface.

Aim is to interact with the Network Module by using commands in the form of successive lines of text (command lines).

CSR: Certificate Signing Request

DC: Direct current.

DCC: Device Communication Control (BACnet).

DN: Distinguished Name (LDAP).

DHCPv6: The Dynamic Host Configuration Protocol version 6 is a network protocol for configuring Internet Protocol version 6 (IPv6) hosts with IP addresses, IP prefixes and other configuration data required to operate in an IPv6 network. It is the IPv6 equivalent of the Dynamic Host Configuration Protocol for IPv4.

DNS: The Domain Name System is a hierarchical decentralized naming system for computers, services, or other resources connected to the Internet or a private network.

DST: The daylight saving time.

EMP: Environmental monitoring probe

GID: Group Identifier is a numeric value used to represent a specific group (LDAP).

HTTPS: HTTPS consists of communication over Hypertext Transfer Protocol (HTTP) within a connection encrypted by Transport Layer Security (TLS).

IPP: Intelligent Power Protector is a web-based application that enables administrators to manage an Devices from a browser-based management console. Administrators can monitor, manage, and control a single Device (UPS, ATS, ePDU) locally and remotely. A familiar browser interface provides secure access to the Device Administrator Software and Device Client Software from anywhere on the network. Administrators may configure power failure settings and define UPS load segments for maximum uptime of critical servers. The UPS can also be configured to extend runtimes for critical devices during utility power failures. For most UPSs, the receptacles on the rear panel are divided into one or more groups, called load segments, which can be controlled independently. By shutting down a load segment that is connected to less critical equipment, the runtime for more critical equipment is extended, providing additional protection.

IPv4: Internet Protocol version 4 is the fourth version of the Internet Protocol (IP).

IPv6: Internet Protocol version 6 is the most recent version of the Internet Protocol (IP).

JSON: JavaScript Object Notation is an open-standard file format that uses human-readable text to transmit data objects consisting of attribute–value pairs and array data types.

kVA: kilovolt-ampere.

LAN: A LAN is a local area network, a computer network covering a small local area, such as a home or office.

LDAP: The Lightweight Directory Access Protocol is an industry standard application protocol for accessing and maintaining distributed directory information services over an Internet Protocol.

MAC: A media access control address of a computer is a unique identifier assigned to network interfaces for communications at the data link layer of a network segment.

MIB: A management information base is a database used for managing the entities in a communication network. Most often associated with the Simple Network Management Protocol (SNMP).

NTP: Network Time Protocol is a networking protocol for clock synchronization between computer systems.

P/N: Part number.

RTC: Real time clock.

RTU: Remote Terminal Unit

S/N: Serial number.

SMTP: Simple Mail Transfer Protocol is an Internet standard for electronic mail (email) transmission.

SNMP: Simple Network Management Protocol is an Internet-standard protocol for collecting and organizing information about managed devices on IP networks and for modifying that information to change device behavior.

SSH: Secure Shell is a cryptographic network protocol for operating network services securely over an unsecured network.

SSL: Secure Sockets Layer, is a cryptographic protocol used for network traffic.

TCP: Transmission Control Protocol

TLS: Transport Layer Security is cryptographic protocol that provide communications security over a computer network.

TFTP: Trivial File Transfer Protocol is a simple lockstep File Transfer Protocol which allows a client to get a file from or put a file onto a remote host.

UID: User identifier (LDAP).

UTC: Coordinated Universal Time is the primary time standard by which the world regulates clocks and time.

UPS: An uninterruptible power supply is an electrical apparatus that provides emergency power to a load when the input power source or mains power fails.

A UPS is typically used to protect hardware such as computers, data centers, telecommunication equipment or other electrical equipment where an unexpected power disruption could cause injuries, fatalities, serious business disruption or data loss.

8 Troubleshooting

8.1 Action not allowed in Control/Schedule/Power outage policy

8.1.1 Symptom

Below message is displayed when you access the Control, Schedule or Power outage policy page.

This action is not allowed by the UPS.

To enable it, please refer to the user manual of the UPS and its instructions on how to configure the UPS settings and allow remote commands.

8.1.2 Possible Cause

- 1- Remote commands are not allowed due to the UPS configuration (see the action below)
- 2- The UPS does not support remote commands.

8.1.3 Action

Refer to the UPS user manual and its instruction on how to configure the UPS settings and allow remote commands.

Example: UPS menu Settings>>>ON/OFF settings>>>Remote command>>>Enable.

8.2 Card wrong timestamp leads to "Full acquisition has failed" error message on Software

8.2.1 Symptoms:

IPP/IPM shows the error message "The full data acquisition has failed" even if the credentials are correct.

8.2.2 Possible cause:

The Network module timestamp is not correct.
Probably the MQTT certificate is not valid at Network module date.

8.2.3 Action:

Set the right date, time and timezone. If possible, use a NTP server, refer to [Contextual help>>>Settings>>>General>>>System details>>>Time & date settings](#) section.

8.3 Client server is not restarting

8.3.1 Symptom

Utility power has been restored, the UPS and its load segments are powered on, but the Client server does not restart.

8.3.2 Possible Cause

The "Automatic Power ON" server setup setting might be disabled.

8.3.3 Action

In the server system BIOS, change the setting for Automatic Power ON to "Enabled".

8.4 EMP detection fails at discovery stage

In the Network Module, in [Contextual help>>>Environment>>>Commissioning/Status](#), EMPs are missing in the Sensor commissioning table.

8.4.1 Symptom #1

The EMPs green RJ45 LED (FROM DEVICE) is not ON.

8.4.1.1 Possible causes

The EMPs are not powered by the Network module.

8.4.1.2 Action #1-1

Launch again the discovery, if it is still not ok, go to Action #1-2.

8.4.1.3 Action #1-2

1- Check the EMPs connection and cables.

Refer to the sections [Servicing the EMP>>>Installing the EMP>>>Cabling the first EMP to the device and Servicing the EMP>>>Installing the EMP>>>Daisy chaining 3 EMPs](#).

2- Disconnect and reconnect the USB to RS485 cable.

3- Launch the discovery, if it is still not ok, go to Action #1-3.

8.4.1.4 Action #1-3

1- Reboot the Network module.

2- Launch the discovery.

8.4.2 Symptom #2

The EMPs orange RJ45 LEDs are not blinking.

8.4.2.1 Possible causes

C#1: the EMP address switches are all set to 0.

C#2: the EMPs are daisy chained, the Modbus address is the same on the missing EMPs.

8.4.2.2 Action #2-1

1- Change the address of the EMPs to have different address and avoid all switches to 0.

Refer to the section [Servicing the EMP>>>Defining EMPs address and termination>>>Manual addressing](#).

2- Disconnect and reconnect the USB to RS485 cable. The address change is only taken into account after an EMP power-up.

3- Launch the discovery, if it is still not ok, go to Action #2-2.

8.4.2.3 Action #2-2

1- Reboot the Network module.

How do I log in if I forgot my password?

Refer to the section [Contextual help>>>Maintenance>>>Services>>>Reboot](#).

2- Launch the discovery.

8.5 How do I log in if I forgot my password?

8.5.1 Action

- Ask your administrator for password initialization.
- If you are the main administrator, your password can be reset manually by following steps described in the [Servicing the Network Management Module>>>Recovering main administrator password](#).

8.6 Software is not able to communicate with the Network module

8.6.1 Symptoms

- In the Network Module, in [Contextual help>>>Protection>>>Agent list>>>Agent list table](#), agent is showing "Lost" as a status.
- In the Network Module, in [Contextual help>>>Settings>>>Certificate>>>Trusted remote certificates](#), the status of the Protected applications (MQTT) is showing "Not valid yet".
- IPP/IPM shows "The authentication has failed", "The notifications reception encountered error".

8.6.2 Possible cause

The IPP/IPM certificate is not yet valid for the Network Module.

Certificates of IPP/IPM and the Network Module are not matching so that authentication and encryption of connections between the Network Module and the shutdown agents is not working.

8.6.3 Setup

IPP/IPM is started.

Network module is connected to the UPS and to the network.

8.6.4 Action #1

Check if the IPP/IPM certificate validity for the Network Module.

STEP 1: Connect to the Network Module

- On a network computer, launch a supported web browser. The browser window appears.
- In the Address/Location field, enter: <https://xxx.xxx.xxx.xxx/> where xxx.xxx.xxx.xxx is the static IP address of the Network Module.
- The log in screen appears.
- Enter the user name in the User Name field.
- Enter the password in the Password field.
- Click **Login**. The Network Module web interface appears.

STEP 2: Navigate to **Settings/Certificates** page

STEP 3: In the **Trusted remote certificates** section, check the status of the **Protected applications (MQTT)**.

If it is "Valid" go to Action#2 STEP 2, if it is "Not yet valid", time of the need to be synchronized with IPP/IPM.

STEP 4: Synchronize the time of the Network Module with IPP/IPM and check that the status of the **Protected applications (MQTT)** is now valid.

Communication will then recover, if not go to Action#2 STEP 2.

8.6.5 Action #2

Pair agent to the Network Module with automatic acceptance (recommended in case the installation is done in a secure and trusted network).



For manual pairing (maximum security), go to [Servicing the Network Management Module>>>Pairing agent to the Network Module](#) section and then go to STEP 2, item 1.

STEP 1: Connect to the Network Module.

- On a network computer, launch a supported web browser. The browser window appears.
- In the Address/Location field, enter: `https://xxx.xxx.xxx.xxx/` where `xxx.xxx.xxx.xxx` is the static IP address of the Network Module.
- The log in screen appears.
- Enter the user name in the User Name field.
- Enter the password in the Password field.
- Click **Login**. The Network Module web interface appears.

STEP 2: Navigate to **Protection/Agents list** page.

STEP 3: In the **Pairing with shutdown agents** section, select the time to accept new agents and press the **Start** button and **Continue**. During the selected timeframe, new agent connections to the Network Module are automatically trusted and accepted.

STEP 4: Action on the agent (IPP/IPM) while the time to accepts new agents is running on the Network Module

Remove the Network module certificate file(s) *.0 that is (are) located in the folder `Eaton\IntelligentPowerProtector\configs\tls`.

8.7 LDAP configuration/commissioning is not working

Refer to the section [Servicing the Network Management Module>>>Commissioning/Testing LDAP](#).

8.8 Password change in My profile is not working

8.8.1 Symptoms

The password change shows "*Invalid credentials*" when I try to change my password in My profile menu:



8.8.2 Possible cause

The password has already been changed once within a day period.

8.8.3 Action

Let one day between your last password change and retry.

8.9 SNMPv3 password management issue with Save and Restore

8.9.1 Affected FW versions

This issue affects SNMP **configuration** done on versions prior to 1.7.0 when applied to versions 1.7.0 or above.

The alarm list has been cleared after an upgrade

8.9.2 Symptom

SNMPv3 connectivity is not properly working after a restore settings on a 1.7.0 version or above.

8.9.3 Cause

The SNMPv3 was **configured** prior to 1.7.0.

In that case, SNMPv3 configuration is not well managed by the Save and by the Restore settings.

8.9.4 Action

Reconfigure your SNMPv3 users and passwords on versions 1.7.0 or above and Save the settings.

The SNMPv3 configuration can then be Restored.

8.10 The alarm list has been cleared after an upgrade

8.10.1 Symptom

After a FW upgrade, the alarm list has been cleared and is now empty.

8.10.2 Action

The alarm list has been saved on a csv file and can be retrieved using Rest API calls.

8.10.2.1 Authenticate:

```
curl --location --request POST 'https://{{domain}}/rest/mbdetnrs/1.0/oauth2/token' \  
--header 'Content-Type: application/json' \  
--data-raw '{ "username":"admin", "password":"supersecretpassword", "grant_type":"password",  
"scope":"GUIAccess" }'
```

8.10.2.2 Get Alarm Log Backup:

```
curl --location --request GET 'https://{{domain}}/rest/mbdetnrs/1.0/alarmService/actions/  
downloadBackup' \  
--header 'Authorization: Bearer {{access_token}}'
```

8.11 The Network Module fails to boot after upgrading the firmware

8.11.1 Possible Cause

- 1- The IP address has changed.
- 2- The Network module LED shows solid red after the upgrade.
- 3- The first boot after the upgrade takes a longer time.

Note: If the application is corrupt, due to an interruption while flashing the firmware for example, the boot will be done on previous firmware.

8.11.2 Action

- 1- Recover the IP address and connect to the card.
- 2- Reset the Network module by using the Restart button on the front panel.
- 3- Wait until the Network module LED shows flashing green.

Refer to [Installing the Network Management Module>>>Accessing the Network Module>>>Finding and setting the IP address](#) section.

8.12 Web user interface is not up to date after a FW upgrade

8.12.1 Symptom

After an upgrade:

- The Web interface is not up to date
- New features of the new FW are not displayed
- An infinite spinner is displayed on a tile

8.12.1.1 Possible causes

The browser is displaying the Web interface through the cache that contains previous FW data.

8.12.1.2 Action

Empty the cache of your browser using F5 or CTRL+F5.

